



**INVITATION FOR BIDS**

**FOR**

**DOJ REPAIRS AND UPGRADES AT GUSTE III**

**HOUSING COMMUNITY - INTERIOR AND**

**EXTERIOR (RE-BID)**

**IFB No. 25-911-01**

**SUBMISSION DATE: DECEMBER 10, 2024**

**2:00pm CST**

**PREPARED BY:**

**Housing Authority of New Orleans  
Procurement and Contracts Department  
4100 Touro Street  
New Orleans, LA 70122**

**ISSUED: November 5, 2024**



Table of Contents

[Table No. 1]

Section	Description
1.0	IFB Information at a Glance and The Agency's Reservation of Rights
2.0	Scope of Work
2.1	General Requirements (See Appendix A for Technical Specifications)
3.0	Bid Requirements
3.1	Bid Submittals
3.2	Entry of Proposed Fees
3.3	Additional Information pertaining to the preceding listed Pricing Items
3.4	Submission Responsibilities
3.5	Bidder's Responsibilities – Contact with the Agency
3.6	Bidder's Responsibilities – Equal Employment Opportunity and Supplier Diversity
3.7	Pre-Bid Conference
3.8	Recap of Attachments
3.9	Bid Results
4.0	Contract Award
4.1	Contract Award Procedure
4.2	Contract Conditions
4.3	Contract Period
4.4	Licensing and Insurance Requirements
4.5	Contract Service Standards
4.6	Prompt Return of Contract Documents
5.0	Index of Tables
6.0	Appendix A and B (Technical Specifications, and Drawings)
7.0	Referenced Attachments

INVITATION FOR BID INFORMATION  
AT A GLANCE

[Table No. 2]

AGENCY CONTACT PERSON	<p><b>Paul Marquette, Senior Procurement Specialist</b> Telephone: (504) 670-3447 E-mail: <a href="mailto:pmarquette@hano.org">pmarquette@hano.org</a></p>
HOW TO OBTAIN THE IFB DOCUMENTS AND ADDENDA ON HANO'S WEBSITE	<ol style="list-style-type: none"> <li>1. Access <a href="http://www.hano.org">www.hano.org</a>.</li> <li>2. Click on the "<b>Business</b>" tab on the blue taskbar.</li> <li>3. Click on "<b>Active Solicitations</b>" and go to the specific solicitation.</li> <li>4. If you have any problems accessing the IFB documents, please contact Procurement at <a href="mailto:pmarquette@hano.org">pmarquette@hano.org</a>.</li> </ol>
PRE-BID CONFERENCE/SITE VISIT	<p><b>A Pre-Bid Conference</b> will be held via Zoom on November 26, 2024, at 2:00pm CST; <a href="https://zoom.us/j/98704824296?pwd=c5r14O53xtZfQPEIa8y9gdMqLZhoMB.1">https://zoom.us/j/98704824296?pwd=c5r14O53xtZfQPEIa8y9gdMqLZhoMB.1</a> Meeting ID: 987 0482 4296 Passcode: 2m2hcD</p>
QUESTION SUBMITTAL DEADLINE	<p><b>November 27, 2024, at 5:00pm</b></p>
HOW TO FULLY RESPOND TO THIS IFB BY SUBMITTING A BID SUBMITTAL	<ol style="list-style-type: none"> <li>1. As directed within Section 3.2.1 of the IFB document, submit proposed pricing, where provided for, within the IFB.</li> <li>2. As instructed within Section 3.0 of the IFB document, deliver <b>one (1)</b> complete set of the required submittals in a <b>sealed</b> envelope clearly marked with the words "<b>Bid Documents</b>" to HANO's Procurement and Contracts Department (address below).</li> </ol>
BID SUBMITTAL RETURN AND DEADLINE	<p><b>December 10, 2024, at 2:00pm CST</b> Zoom link: <a href="https://zoom.us/j/92208659714?pwd=abHyJmlBlg5TPGAKklBj5O7nMRFkXn.1">https://zoom.us/j/92208659714?pwd=abHyJmlBlg5TPGAKklBj5O7nMRFkXn.1</a> Meeting ID: 922 0865 9714 Passcode: 1ATKrE Housing Authority of New Orleans Procurement and Contracts Department 4100 Touro Street, New Orleans, LA 70122</p>

- 1.0 THE AGENCY'S RESERVATION OF RIGHTS.** The Agency reserves the right to:
- 1.1 Right to Reject, Waive, or Terminate the IFB.** Reject any or all bids, to waive any informality in the IFB process, or to terminate the IFB process at any time, if deemed by the Agency to be in its best interests.
  - 1.2 Right to Not Award.** Not to award a contract pursuant to this IFB.
  - 1.3 Right to Terminate.** Terminate a contract awarded pursuant to this IFB, at any time for its convenience upon ten (10) days written notice to the successful bidder(s).
  - 1.4 Right to Determine Time and Location.** Determine the days, hours, and locations that the successful bidder(s) shall provide the services called for in this IFB.
  - 1.5 Right to Retain Bids.** Retain all bids submitted and not permit withdrawal after bid opening and without the written consent of HANO's Contracting Officer (CO).
  - 1.6 Right to Negotiate.** Negotiate with the apparent, low bidder
  - 1.7 Right to Reject Any Bid.** Reject and not consider any bid that does not meet the requirements of this IFB, including but not necessarily limited to incomplete bids and/or bids offering alternate or non-requested services.
  - 1.8 No Obligation to Compensate.** Have no obligation to compensate any bidder for any costs incurred in responding to this IFB.
  - 1.9 Right to Prohibit.** At any time during the IFB or contract process to prohibit any further participation by a bidder or reject any bid submitted that does not conform to any of the requirements detailed herein.
  - 1.10 Right to Reject - Obtaining Competitive Solicitation Documents.** HANO's website and Procurement Staff are the only official and appropriate means to obtain the IFB documents (and any other information pertaining to this IFB such as addenda). Accordingly, by submitting a response to this IFB the respondent thereby affirms that he/she obtained all information on the website.

**2.0 SCOPE OF WORK**

The Housing Authority of New Orleans (HANO) is seeking General Contractors to perform repairs and upgrades to the interior and exterior of Guste III Housing Community.

**THE BASE BID**

**2.1 GENERAL REQUIREMENTS:** The Contractor shall complete repairs as indicated in the Specifications in Appendix A and B.

**3.0 BID REQUIREMENTS.**

- A. Destructive and selective demolition to designate parts of the building to repair and upgrade code issues throughout the building.
- B. Contractor to make the repairs and upgrades stated in the contract documents.
- C. Work to be performed in a fully occupied building. Work shall be sequenced to accommodate the tenants. Contractor shall work with the building’s management on the scheduling of the work.

**3.1 BID SUBMITTALS**

[Table No. 3]

(1) IFB Section	(3) Description
3.1.1	<b>Form of Bid.</b> This Form must be fully completed, executed where provided thereon and submitted as a part of the bid submittal. <b>(REQUIRED)</b>
3.1.2	<b>Form HUD 5369-A (8/93), <i>Certifications and Representations of Bidders, Construction Contract.</i></b> This Form is attached hereto as Attachment B to this IFB document. This form must be fully completed, executed where provided thereon and submitted under this tab as a part of the bid submittal. Attachment E <b>(REQUIRED)</b>
3.1.2.1	<b>Form HUD SF-LLL Disclosure of Lobbying Activities.</b> This Form is attached hereto as Attachment B-1 to this RFP document. This form <b>must</b> be fully completed, executed where provided thereon and submitted under this tab as a part of the bid submittal. <b>(REQUIRED)</b>
3.1.2.2	<b>Form HUD-50071 Certification of Payments to Influence Federal Transactions</b> This Form is attached hereto as Attachment B-2 to this IFB document. This form must be fully completed, executed where provided thereon and submitted under this tab as a part of the bid submittal.

3.1.2.3	<b>Form HUD-50070 Certification for a Drug-Free Workplace</b> This Form is attached hereto as Attachment B-3 to this RFP document. This form must be fully completed, executed where provided thereon and submitted under this tab as a part of the bid submittal. <b>(REQUIRED)</b>
3.1.3	<b>Profile of Firm Form.</b> The Profile of Firm Form is attached hereto as Attachment C to this IFB document. This two (2) page Form must be fully completed, executed, and submitted as a part of the bid submittal. <b>(REQUIRED)</b>
3.1.4	<b>Equal Employment Opportunity/Supplier Diversity Policy &amp; Statement.</b> The bidder must submit a copy of its Equal Opportunity Employment Policy <b>and</b> a complete description of the positive steps it will take to ensure compliance, to the greatest extent feasible, with the regulations detailed within the following Section 3.6 herein pertaining to supplier diversity (i.e., small, minority-, and women-owned businesses). <b><u>This statement MUST be submitted on the Company's letterhead.</u></b> <b>(REQUIRED)</b>
3.1.5	<b>Acknowledgement of Addenda.</b> Please check HANO's website under "Business" and "Active Solicitations" to confirm that you have read and acknowledged in writing all addenda issued and submit your acknowledgment of each addendum on Attachment H. <b>(REQUIRED)</b>
3.1.6	<b>Entry of Proposed Fees, Louisiana Uniform Public Work Bid Form</b> This bidder must submit their proposed fees on this form. The total base bid is inclusive of all fees associated with this project. Attachment I.
3.1.7	<b>Certification of Contractor Non-Exclusion</b> Attachment J
3.1.8	<b>Subcontractor/Joint Venture Information.</b> The bidder shall identify whether or not he/she intends to use any subcontractors for this job, if awarded, and/or if the bid is a joint venture with another firm. Please remember that all information required from the bidder under the preceding submittals must also be included for any major subcontractors (10% or more) or from any joint venture. <b>(If you do NOT plan to sub-contractor, include your statement on letter head and include in bid submittal)</b>
3.1.10	<b>Vendor Registration Form</b> Attachment L
3.1.11	<b>Bid Bond.</b> All bids must be accompanied by a bid guarantee at the time of submission, which shall be in the form of a certified check, cashier's check, or bid bond for five percent (5%) of the contract price of work to be done, as evidence of good faith of the bidder. <b>(REQUIRED)</b> Attachment M
3.1.12	<b>Statement of Bidder's Qualifications.</b> This form must be submitted as a contributor to determining whether the bidder is responsible. <b>(REQUIRED)</b> Attachment P
3.1.13	<b>Corporate Resolution.</b> This form or a similar form must be submitted authorizing the signature of the bidder on behalf of the

	business. <b>(REQUIRED)</b> Attachment R
3.1.14	<b>Employment, Training and Contracting Plan. Pages 21-24 MUST</b> be completed and submitted with the sealed bid. The lowest bidder <b>MUST</b> complete the remaining required pages before Notice of Award is issued.
3.1.15	<b>Section 3 Preference Form Attachment (D) (If you do NOT plan to participate in Section 3, indicate so on the Section 3 attachment)</b>

**3.2 Entry of Proposed Fees.**

3.2.1 *A lump sum fee shall be submitted on the Louisiana Uniform Public Work Bid Form only (Attachment I). This form must bear an original signature, stamped signatures are not acceptable. Do not refer to any of your fees or costs on other submittals.*

3.2.2 **Pricing Items.** The base bid is all-inclusive of the lump sum work for all related costs that the successful bidder will incur to provide the noted goods and services, including, but not limited to employee wages and benefits; clerical support; overhead; profit; licensing; insurance; materials; supplies; tools; equipment; long distance telephone calls; travel expenses; document copying not specifically agreed to by the Agency; etc.

Bidders shall visit the project site prior to submitting a bid to familiarize themselves with the project. By submitting a bid, bidders acknowledge that they have visited the project site and are completely familiar with existing conditions and the full Scope of Work. Failure to properly assess the full Scope of Work will not be cause for an increase in the Contract Price and/or Time.

[Table No. 4]

(1) IFB Section	(2) Designation:	(3) Unit Price	(4) Quantity	(8) Total Cost:
Appendix A and B	Lump Sum Cost for Interior and Exterior Repairs at Guste III Housing Community			
Total Base Bid				To be added to Louisiana Uniform Public Bid Form

**3.3 Additional Information pertaining to the preceding listed Pricing Items.**

3.3.1 **Manufacturer/Brand Names.** Wherever HANO specifies the name of a certain brand, make, manufacturer, or uses a definite specification, they are used only to denote the quality standard of product desired, and they do not restrict bidders to

the specific brand, make, manufacturer, or specification named. They are used only to set forth and convey to prospective bidders the general style, type, character, and quality of product desired. Equivalent products may be acceptable.

- 3.3.2 Price Escalation.** Pertaining to the ensuing contract, there shall be **no** escalation of the proposed unit costs allowed at any time during the awarded contract.
- 3.3.3 Prior Approval Required.** Please note that the successful bidder shall NOT conduct any additional work without the prior written authorization of the Agency representative (which will occur, at the Agency's discretion, via delivery of a Notice to Proceed and/or a signed Change Order, which may take the form of an e-mail). Failure to abide by this directive shall release the Agency of any obligation to pay the successful bidder for any work conducted without the noted prior written authorization.
- 3.3.4 No Deposit/No Retainer.** The Agency will NOT pay any retainer fees as a result of award of the ensuing contract. This means that the Agency will pay the successful bidder for actual work performed only and pertaining to the fixed fee Pricing Item.
- 3.4 Bid Submission.** All submittals must be submitted in a sealed enclosure and all bids must be submitted and time-stamped received in the designated Agency office by no later than submittal deadline stated herein (or within any ensuing addendum). A total of one (1) original (stamped signature will not be accepted) signature copy bid submittal, shall be placed in a sealed package, and addressed to:

Housing Authority of New Orleans Procurement and Contracts Department  
Attn: Cheryl Morgan, Procurement and Contracts Manager  
4100 Touro Street  
New Orleans, Louisiana 70122

- 3.4.1 Exterior of Submittal Package.** The package exterior must clearly denote the above noted IFB number and must have the bidder's name, return address, state of Louisiana Contractor's License number and date and time bids are due. Bids received after the published deadline will not be accepted. Bids that do not have the required Contractor's License number on the outside of the bid package will not be accepted.
- 3.4.2 Submission Conditions.** DO NOT FOLD OR MAKE ANY ADDITIONAL MARKS, NOTATIONS OR REQUIREMENTS ON THE DOCUMENTS TO BE SUBMITTED! Bidders are not allowed to change any requirements or forms contained herein, either by making or entering onto these documents or the documents submitted any revisions or additions; and if any such additional marks, notations or requirements are entered on any of the documents that are submitted to the Agency by the bidder, such may invalidate that bid. If, after accepting such a bid, the Agency decides that any such entry has not changed the intent of the bid that the Agency intended to receive, the Agency may accept the bid and the bid shall be considered by the Agency as if those additional marks,

notations or requirements were not entered on such. By accessing and downloading these documents, each prospective bidder that does so is thereby agreeing to confirm all notices that the Agency delivers to him/her as instructed, and by submitting a bid, the bidder is thereby agreeing to abide by all terms and conditions published herein and by addendum pertaining to this IFB.

**3.4.3 Submission Responsibilities.** It shall be the responsibility of each bidder to be aware of and to abide by all dates, times, conditions, requirements and specifications set forth within all applicable documents issued by the Agency, including the IFB document, the documents listed within the following Section 3.8 herein, and any addenda and required attachments submitted by the bidder. By virtue of completing, signing, and submitting the completed documents, the bidder is stating his/her agreement to comply with all conditions and requirements set forth within those documents. Written notice from the bidder not authorized in writing from HANO to exclude any of the Agency requirements contained within the documents may cause that bidder to not be considered for award.

**3.5 Bidder’s Responsibilities – Contact with the Agency.** It is the responsibility of the bidder to address all communication and correspondence pertaining to this IFB process to the Procurement staff only. Bidders must not make inquiry or communicate with any other Agency staff member or official (including members of the Board of Commissioners) pertaining to this IFB. Failure to abide by this requirement will be cause for the Agency to not consider a bid submittal received from any bidder who may not have abided by this directive. **This provision will be strictly enforced.**

**3.5.1 Addenda.** All questions and requests for information must be addressed in writing to **Paul Marquette, Senior Procurement Specialist, at [pmarquette@hano.org](mailto:pmarquette@hano.org)**. Procurement will respond to all such inquiries in writing by addendum to all prospective bidders (i.e., firms or individuals that have obtained the IFB Documents). Bidders must provide written acknowledgement of addenda with their submissions.

**3.6 Bidder’s Responsibilities – Equal Employment Opportunity and Supplier Diversity.** Both the Contractor and the Agency have, pursuant to HUD regulation, certain responsibilities pertaining to the hiring and retention of personnel and subcontractors.

**3.6.1** Within 2 CFR §200.321 it states:

**3.6.1.1** Contracting with small and minority businesses, women's business enterprises, and labor surplus area firms.

**3.6.1.2 (a)** The non-Federal entity must take all necessary affirmative steps to assure that minority businesses, women's business enterprises, and labor surplus area firms are used when possible.

**3.6.1.3 (2)** Affirmative steps must include:



- 3.6.1.3.1 (1) Placing qualified small and minority businesses and women's business enterprises on solicitation lists;
- 3.6.1.3.2 (2) Assuring that small and minority businesses, and women's business enterprises are solicited whenever they are potential sources;
- 3.6.1.3.3 (3) Dividing total requirements, when economically feasible, into smaller tasks or quantities to permit maximum participation by small and minority business, and women's business enterprises;
- 3.6.1.3.4 (4) Establishing delivery schedules, where the requirement permits, which encourage participation by small and minority business, and women's business enterprises;
- 3.6.1.3.5 (5) Using the services and assistance, as appropriate, of such organizations as the Small Business Administration and the Minority Business Development Agency of the Department of Commerce; and
- 3.6.1.3.6 (6) Requiring the prime contractor, if subcontracts are to be let, to take the affirmative steps listed in paragraphs (1) through (5) of this section.

3.6.2 Within HUD Procurement Handbook 7460.8 REV 2 it states:

- 3.6.2.1 **Section 15.5.A, Required Efforts.** Consistent with Presidential Orders 11625, 12138, and 12432, the <Agency> shall make every effort to ensure that small businesses, MBEs, WBEs, and labor surplus area businesses participate in <Agency> contracting.
- 3.6.2.2 **Section 15.5.B, Goals.** <The Agency> is encouraged to establish goals by which they can measure the effectiveness of their efforts in implementing programs in support of . . . contracting with disadvantaged firms. It is important to ensure that the means used to establish these goals do not have the effect of limiting competition and should not be used as mandatory set-aside or quota, except as may otherwise be expressly authorized in regulation or statute. Some localities have adopted minority contracting set-aside policies or geographic limitations, which may be in conflict with Federal requirements for full and open competition.

3.6.3 Within HANO's Procurement Policy it states that our Agency will:

**3.6.3.1 Assistance to Small and Other Business, Required Efforts:**

- 3.6.3.1.1 Including such firms, when qualified, on solicitation mailing lists;
- 3.6.3.1.2 Encouraging their participation through direct solicitation of bids or bids whenever they are potential sources;
- 3.6.3.1.3 Dividing total requirements, when economically feasible, into smaller tasks or quantities to permit maximum participation by such firms;
- 3.6.3.1.4 Establishing delivery schedules, where the requirement permits, which encourage participation by such firms;
- 3.6.3.1.5 Using the services and assistance of the Small Business Administration, and the Minority Business Development Agency of the Department of Commerce; and,
- 3.6.3.1.6 Requiring prime contractors, when subcontracting is anticipated, to take the positive steps listed above.

**3.6.4 Requirements.** Accordingly, please see HANO'S Employment, Training, and Contracting Policy attached which details the information pertaining to this issue that the bidder must submit in response to this bid showing compliance, to the greatest extent feasible, with these regulations.

**3.7 Pre-bid Conference.** A pre-bid conference is scheduled for TBD via Zoom: <https://zoom.us/j/98704824296?pwd=c5r14O53xtZfQPEIa8y9gdMqLZhoMB.1>  
Meeting ID: 987 0482 4296 Passcode: 2m2hcD.

**3.8 Recap of Attachments.** It is the responsibility of each bidder to verify that he/she has received the following attachments pertaining to this IFB, which are included as a part of this IFB:

[Table No. 5]

(1) IFB Section	(2) Document No.	(3) Attachment	(4) Description
3.8.1	1.0		This IFB Document
3.8.2	2.0		"No-Bid" Response Form
3.8.3	3.0	A	Form of Bid
3.8.4	4.0	B	Form HUD-5369 (10/2002), <i>Instructions to Bidders for Contracts Public and Indian Housing</i>

**INVITATION FOR BIDS (IFB) No. 25-911-01 DOJ Repairs and Upgrades at Guste III Housing Community - Interior and Exterior (Re-Bid)**

3.8.5	5.0	B-1	Form SF-LLL <i>Disclosure of Lobbying Activities</i>
3.8.6	6.0	B-2	Form HUD-50071 (01/14), <i>Certification of Payments to Influence Federal Transactions</i>
3.8.7	7.0	B-3	Form HUD-50070 (01/14), <i>Certification for a Drug-Free Workplace</i>
3.8.8	8.0	C	Profile of Firm Form
3.8.9	9.0	D	Section 3 Business Preference Form
3.8.10	10.0	E	Form HUD-5369-A (11/92), <i>Representations, Certifications, and Other Statements of Bidders</i>
3.8.11	11.0	F	<i>Supplemental Conditions for Bidders &amp; Contractors (SIPC)</i>
3.8.12	12.0	G	HUD-5370 (01/2014), <i>General Conditions for Construction Contracts</i>
3.8.13	13.0	H	Acknowledgement of Addenda
3.8.14	14.0	I	Entry of Proposed Fees, <i>Louisiana Uniform Public Work Bid Form</i>
3.8.15	15.0	J	Certification of Contractor Non-Exclusion
3.8.16	16.0	K	E-Verification Affidavit ( <b>Only required to be submitted post-bid by the awarded bidder</b> )
3.8.17	17.0	L	Vendor Registration Form
3.8.18	18.0	M	Bid Bond Sample Form
3.8.19	19.0	N	Performance Bond Sample Form ( <b>Only required post-bid by the awarded bidder</b> )
3.8.20	20.0	O	Davis Bacon Wage Rates
3.8.21	21.0	P	Employment, Training and Contracting Policy
3.8.22	22.0	Q	Statement of Bidder's Qualifications
3.8.23	23.0	R	Corporate Resolution

### 3.9 BID RESULTS.

**3.9.1 Notice of Bid Award.** If an award is completed, all bidders will receive by e-mail either a Notice of Award or Notice of Regrets. Such notice shall inform all bidders of:

3.9.1.2 Which bidder received the award;

3.9.1.3 Where each bidder placed in the process as a result of the evaluation of the bids received;

3.9.1.4 The cost or financial offers received from each bidder;

3.9.1.5 Each bidder's right to a debriefing and to protest.

**3.9.2 Restrictions.** All persons having familial (including in-laws) and/or employment relationships (past or current) with principals and/or employees of a bidder entity will be excluded from participation on the Agency evaluation committee. Similarly, all persons having ownership interest in and/or contract with a bidder entity will be excluded from participation on the Agency evaluation committee.

#### 4.0 CONTRACT AWARD.

**4.1 Contract Award Procedure.** If a contract is awarded pursuant to this IFB, the following detailed procedures will be followed:

**4.1.1** By completing, executing and submitting a bid, the "bidder is thereby agreeing to abide by all terms and conditions pertaining to this IFB as issued by the Agency," including the contract clauses already attached in Attachment G. Accordingly, the Agency has no responsibility to conduct after the submittal deadline any negotiations pertaining to the contract clauses already published.

**4.2 Contract Conditions.** The following provisions are considered mandatory conditions of any contract award made by HANO pursuant to this IFB:

**4.2.1 Contract Form.** The Agency will not execute a contract on the Contractor's form – contracts will only be executed on the Agency's form (please see standard contract clauses on Attachment F and G each attached hereto), and by submitting a bid the Contractor agrees to do so (please note that HANO reserves the right to amend this form as the Agency deems necessary). However, the Agency will during the IFB process (prior to the posted question deadline) consider any contract clauses that the bidder wishes to include therein and submits in writing a request for the Agency to do so; but the failure of the Agency to include such clauses does not give the Contractor the right to refuse to execute the Agency's contract form. It is the responsibility of each prospective bidder to notify the Agency, in writing, prior to submitting a bid, of any contract clause that he/she is not willing to include in the final executed contract and abide by. The Agency will consider and respond to such written correspondence, and if the prospective bidder is not willing to abide by the Agency's response (decision), then that prospective bidder shall be deemed ineligible to submit a bid.

**4.2.1.1 Mandatory HUD Forms.** Please note that HANO has no legal right or ability to (and will not) at any time negotiate any clauses contained within ANY of the HUD forms included as a part of this IFB.

**4.2.1.2 E-Verify Affidavit.** The Contractor must certify compliance with Louisiana's E-Verify requirements, in that the Contractor is registered, uses, and will continue to use the E-Verify, Federal Work Authorization Program throughout the contract period. This Form is attached hereto as Attachment G-4 to this IFB document. This 1-page

Form will be fully completed and executed where provided thereon by the successful bidder and will be a part of the ensuing contract (NOTE: It is NOT necessary to complete and submit this form as a part of the bid submittal – only the awarded bidder(s) will be required to do so as a part of the contract execution).

- 4.2.2 Assignment of Personnel.** HANO shall retain the right to demand and receive a change in personnel assigned to the work if HANO believes that such change is in the best interest of HANO and the completion of the contracted work.
- 4.2.3 Unauthorized Subcontracting Prohibited.** The Contractor shall not assign any right, nor delegate any duty for the work proposed pursuant to this IFB (including, but not limited to, selling or transferring the contract) without the prior written consent of HANO. Any purported assignment of interest or delegation of duty, without the prior written consent of HANO shall be void and may result in the cancellation of the contract with the Agency, or may result in the full or partial forfeiture of funds paid to the Contractor as a result of the proposed contract; as determined by HANO.
- 4.3 Time of Completion.** The Contractor shall commence work under this contract at the time stipulated in the written “Notice to Proceed” (NTP) issued by the local authority. The Contractor shall complete the work in **12 Months**. The work shall be considered complete only when the Local Authority has issued its formal “Certificate of Acceptance”.
- 4.4 Licensing and Insurance Requirements.** Prior to award (but not as a part of the bid submission) the *Contractor* will be required to provide:
- 4.4.1 The project shall be awarded only to contractors who are licensed under State of Louisiana Contractors License Law La. R.S. 37:2150-2192 with a major classification in Building Construction/Roofing.**
- 4.4.2 Workers Compensation Insurance.** An original certificate evidencing the bidder’s current industrial (worker’s compensation) insurance carrier and coverage amount not less than \$100,000.00 (NOTE: Workers Compensation Insurance will be required of any Contractor that has employees other than just the owner working on-site to provide the services);
- 4.4.3 General Liability Insurance.** An original certificate evidencing General Liability coverage, naming HANO as an additional insured, together with the appropriate endorsement to said policy reflecting the addition of HANO as an additional insured under said policy (minimum of \$1,000,000 each occurrence, general aggregate minimum limit of \$1,000,000, together with damage to premises and fire damage of \$50,000 and medical expenses any one person of \$5,000), with a commercially reasonable deductible (i.e., “commercially reasonable,” meaning at least 1% of the “general aggregate minimum” of the policy, with a maximum deductible amount of \$50,000);**Automobile Insurance.** An original certificate

showing the bidder’s automobile insurance coverage in a combined single limit of \$500,000. For every vehicle utilized during the term of this program, when not owned by the entity, each vehicle must have evidence of automobile insurance coverage with limits of no less than \$100,000/\$300,000 and medical pay of \$5,000.

**4.4.4 City/Parish/State Business License.** If applicable, a copy of the bidder’s business license allowing that entity to provide such services within the City of New Orleans, Orleans Parish, and/or the State of Louisiana.

**4.4.5 Certificates/Profile of Firm Form.** Pertaining to the aforementioned (within Sections 5.4.1 through 5.4.5) insurance certificates and licenses, each bidder is required to enter related information where provided for on the Profile of Firm Form (do not attach or submit copies of the insurance certificates or licenses within the bid submittal – we will garner the necessary documents from the successful bidder prior to contract execution).

**4.5 Contract Service Standards.** All work performed pursuant to this IFB must conform and comply with all applicable local, state and federal codes, statutes, laws, and regulations.

**4.5 Prompt Return of Contract Documents.** Any and all documents required to complete the contract, including contract signature by the successful bidders, shall be provided to the Agency within **10 workdays** of notification by the Agency.

**Index of Tables**

[Table No. 8]

Table	Description
1	Table of Contents
2	IFB Information at a Glance
4	Pricing Items
5	Recap of Attachments
8	Index of Tables

[THIS SECTION INTENTIONALLY LEFT BLANK]

# Appendix A

## Summary and Scope of Work

# Specifications



***PROJECT MANUAL***  
***FOR***  
***DOJ REPAIRS AND UPGRADES***  
***AT***  
***GUSTE III COMMUNITY INTERIOR***  
***& EXTERIOR WORK ITEMS***  
***1301 Simon Bolivar Ave.***  
***New Orleans, Louisiana 70113***

***HANO***  
***Housing Authority of New Orleans 4100***  
***Touro Street***  
***New Orleans, Louisiana 70122***

***Evette Hester - Executive Director***

***IFB # 24-912-33***  
***ECM Project No. 22462.14 /15***



***Prepared by:***

***ECM Consultants, Inc.***

***Engineers • Architects • Construction Managers***  
***1301 Clearview Pkwy, Suite 200, Metairie, Louisiana 70001***

***June 21, 2024***

**SET NO. \_\_\_\_\_**



## TABLE OF CONTENTS

<u>SECTION</u>	<u>PAGE NUMBER</u>
 <b><u>DIVISION 0 – BID DOCUMENTS</u></b>	
FRONT END DOCUMENTS	
 <b><u>DIVISION 1 – GENERAL REQUIREMENTS</u></b>	
01010 - SUMMARY OF WORK.....	3 pages
01045 - CUTTING AND PATCHING.....	3 pages
01300 – SUBMITTALS.....	4 pages
01315 - PROGRESS SCHEDULES.....	2 pages
01700 – PROJECT CLOSEOUT.....	8 pages
 <b><u>TECHNICAL SPECIFICATIONS</u></b>	
02220 – SELECTIVE DEMOLITION.....	2 pages
05500 – METAL FABRICATIONS.....	3 pages
060574 – PERSERVATIVE TREATED WOOD.....	4 pages
06100 – ROUGH CARPENTRY.....	3 pages
066300 – PLASTIC FABRICATIONS.....	5 pages
07920 – JOINT SEALANTS.....	3 pages
09900 – INTERIOR PAINTING.....	11 pages
099113 – EXTERIOR PAINTING.....	7 pages

**TABLE OF CONTENTS (continued)**

**SUPPLEMENTAL INFORMATION – APPENDIXES**

**ATTACHMENT A – Guste III Development Retrofit Plan (Case 2 :22-cv-03568-LMA-DPC)**

**ATTACHMENT B – Unit Type Scope of Work Sheets**

**ATTACHMENT C – 081613 – Fiberglass Doors (original specification section)**

# DIVISION

# 1

## **GENERAL REQUIREMENTS**

## **SECTION 01010**

### **SUMMARY OF WORK**

#### **PART 1 – GENERAL**

##### **1.1 RELATED DOCUMENTS**

- A. Drawings and general provisions of the contract, including General and Supplementary Conditions and Divisions 1 Specifications Section, apply to the work of this Section.

##### **1.2 SCOPE OF WORK**

###### **THE BASE BID**

- A. Destructive and selective demolition to designate parts of the building to repair and upgrade code issues throughout the building.
- B. Contractor to make the repairs and upgrades stated in the contract documents.
- C. Work to be performed in a fully occupied building. Work shall be sequenced to accommodate the tenants. Contractor shall work with the building's management on the scheduling of the work.

##### **1.3 GENERAL**

- A. The Contractor shall furnish all labor, materials, equipment tools, service, and incidentals to complete all work required by these specifications and as shown on the drawings and as directed by the engineer/architect.
- B. The Contractor shall perform the work and make ready for use of the building. If any damages to existing equipment or the building are made during construction, contractor will rectify at his own cost.
- C. Furnish and install all materials, equipment, and labor which is reasonably and properly inferable and necessary for the proper completion of the work, whether specially indicated in the Contract documents or not.
- D. Protect all existing building components and contents from damage. It is intended that any existing building components and contents in place shall be repaired to original condition if damaged by work of this Contract.
- E. Contractor shall verify all field and project conditions prior to preparing his bid. Any conditions not described in these drawings and specifications shall be brought to the attention of the A/E ten (10) days prior to bid date. Failure to do so shall render the contractor responsible for correction of this condition should he be awarded the contract.
- F. The work "provide" as used in these specifications and on the drawings will be termed to mean "furnish and install".
- G. Visit and examine the project site with all authorities concerned in order to become familiar with all existing conditions pertinent to the work to be performed thereon. No additional compensation will be allowed for failure to be so informed. Pay all costs and fees for utility connections as applicable.

- H. All work shall be performed in a neat and workmanlike manner and in accordance with all codes, standards, and requirements of the industry.
- I. Check all specifications and all drawings and bring to the attention of the A/E any conflicts or variations as shown or noted.
- J. Specifications and accompanying drawings apply to all material and / or labor for construction of work specified herein and shown on drawings.
- K. The Contractor shall pay for all taxes, license, and permits required for execution of the work. Note: This is a sales tax-exempt project. Refer to the Front-End documents in Bid Package.
- L. For any points which are not clear, or from items and/or details which the Contractor feels are in need of clarification, provide request of clarifications in writing to HANO's Procurement Department. Refer to Front-End Documents in Bid Package.
- M. The drawings and the specifications are complementary and what is shown and/or called for shall be furnished and installed the same as if shown and/or called for in the other.
- N. In case of discrepancies and/or ambiguities in the drawings and/or in the specifications, submit requests for clarifications in writing to HANO's Procurement Department. Refer to the Front-End Documents in the Bid Package. Failure to do so on the part of the successful bidder shall be construed as explicit agreement on his part to abide by the A/E's decision in such matters.

#### **1.4 WORK SEQUENCE**

- A. Contractor is responsible for work sequence.

#### **1.5 CONTRACTOR USE OF PREMISES**

- A. Confine operations at site to areas permitted by law, ordinances, permits, Contract documents, and the Owner.
- B. Do not unreasonably encounter the site with materials or equipment. Assume full responsibility for protection and safekeeping of products stored on premises. Move stored products which interfere with operation of Owner.
- C. Do not load structures with weight that will endanger structure.
- D. Use of site – Limit use of site for work and storage. Coordinate parking areas, materials delivery, and storage areas at site with Architect, HANO and Property Manager of Lafitte Senior.
- E. In no case shall the work interfere with existing streets, drives, walks, passageways, pedestrian traffic, and the like. Comply with provisions of the contract and regulatory of the contract and regulatory ordinances.
- F. Contractor shall at all times conduct his operations to ensure the least inconvenience to the general public.

**1.6 CONSTRUCTION AREAS**

- A. Contractor shall limit his use of the construction areas for work and for storage to allow for work by other contractors, Owner's use, and public use as applicable.
- B. Assume full responsibility for the protection and safekeeping of products under this contract stored on site.
- C. Move any stored products under Contractor's control which interfere with operations of the Owner or separate contractor.
- D. Obtain and pay for the use of additional storage or work areas needed for operation.
- E. It is assumed there will be no need for street closures on this project. Should the need arise, the Contractor shall submit for and obtain the permits required for any street closures.

**END OF SECTION**

## **SECTION 01045**

### **CUTTING AND PATCHING**

#### **PART 1 - GENERAL**

##### **1.1 RELATED DOCUMENTS**

Drawings and general provisions of contract, including General and Supplementary Conditions and Division-1 Specification Sections apply to work of this Section.

##### **1.2 SCOPE OF WORK**

The work done under this section includes the furnishing of all labor, materials, equipment, and services necessary to complete the cutting, fitting, and patching required in the execution of this Project.

##### **1.3 DESCRIPTION**

Contractor shall be responsible for all cutting, fitting, and patching, required to complete the work and/or to:

- A. Make its several parts fit together properly.
- B. Uncover portions of the work to provide for installation of ill-timed work.
- C. Remove and replace defective work.
- D. Remove and replace work not conforming to requirements of the Contract documents.
- E. Provide repairs to match the finishes of the adjacent construction. Any area receiving corrective work relating in painting, the entire wall surface where the patch is made shall be painted.

##### **1.4 SUBMITTALS**

- A. For cutting not indicated to be performed in the documents, submit a written request to A/E three (3) working days in advance of executing any cutting or alteration which affects:
  - 1. The structural value or integrity of any element of the Project.
  - 2. The integrity or effectiveness of weather-exposed or moisture-resistant elements or systems.
  - 3. The efficiency, operational life, maintenance, or safety of operational elements.
  - 4. The visual quality of sight-exposed elements.
- B. The request shall include:

1. Identification of the Project.
  2. Description of the affected work.
  3. The necessity for cutting, alteration, or excavation.
  4. The effect on the structural or weatherproof integrity of the Project.
  5. Description of the proposed work:
    - a. The scope of cutting, patching, alteration, or excavation.
    - b. The trades who will execute the work.
    - c. Products proposed to be used.
    - d. The extent of refinishing to be done.
  6. Alternatives to cutting and patching.
  7. Cost proposal, when applicable.
  8. Written permission of any separate contractor whose work will be affected.
- C. Should conditions of the work or the schedule indicate a change of products from the original installation, Contractor shall submit a request for substitution.
- D. Submit a written notice to A/E designating the date and the time the work will be uncovered.

## **PART 2 - PRODUCTS**

### **2.1 MATERIALS**

Comply with specifications and standards for each specific product involved.

## **PART 3 - EXECUTION**

### **3.1 INSPECTION**

- A. Inspect existing conditions of the Project, including elements subject to damage or to movement during cutting and patching.
- B. After uncovering work, inspect the conditions affecting the installation of products or performance of the work.
- C. Report unsatisfactory or questionable conditions to the A/E in writing; do not proceed with the work until the A/E has provided further instructions.

### **3.2 PREPARATION**

- A. Provide adequate temporary support as necessary to assure the structural value or integrity of the affected portion of the work.
- B. Provide devices and methods to protect other portions of the Project from damage.
- C. Provide protection from the elements for that portion of the Project which may be



exposed by cutting and patching work.

- D. The Contractor shall be responsible for and shall properly protect all conduit, wires, equipment, drains, pipes, and other property of the Owner's or public service corporations which are not noted to be demolished or removed.

### **3.3 PERFORMANCE**

- A. Execute cutting and patching by methods which will prevent damage to existing building components and contents and will provide proper surfaces to receive installation of repairs.
- B. Execute fitting and adjustment of products to provide a finished installation to comply with specified products, functions, tolerances, and finishes.
- C. Restore work which has been cut or removed; install new products to provide completed work in accordance with requirements of Contract documents.
- D. Fit work airtight to pipes, sleeves, ducts, conduit, and other penetrations through surfaces.
- E. Refinish entire surfaces as necessary to provide an even finish to match adjacent finishes.
  - 1. For continuous surfaces, refinish to nearest expansion joint.
  - 2. For an assembly, refinish the entire unit.

**END OF SECTION**

## **SECTION 01300**

### **SUBMITTALS**

#### **PART 1 – GENERAL**

##### 1.1 **GENERAL:**

- A. This specification Section is intended to augment the provisions of Division 0 documents. The specific requirements of those documents shall supersede in the event of direct conflict with any provision of this specification Section as stated herein.

##### 1.2 **DESCRIPTION OF WORK:**

- A. This Section specifies administrative and procedural requirements for submittals required for performance of the Work, including:

- 1. Submittal Schedule
- 2. Shop Drawings
- 3. Product Data
- 4. Samples

- B. Administrative Submittals:

- 1. Refer to Division-1 and other Contract Documents for requirements for administrative submittals. Such submittals include, but are not limited to:
  - a. Permits
  - b. Applications for payment
  - c. Performance and payment bonds
  - d. Insurance Certificates

##### 1.3 **SUBMITTAL PROCEDURES:**

- A. Submittal Preparation:

- 1. Place a permanent label, title block, or submittal data sheet (sample at end of this Section) attached to each individual submittal for identification.
- 2. Include the following information on the label for processing and recording action taken:
  - a. Project name
  - b. Date
  - c. Name and address of Architect
  - d. Name and address of General Contractor
  - e. Name and address of Owner
  - f. Name, phone number and address of subcontractor
  - g. Name, phone number and address of supplier
  - h. Name and phone number of manufacturer and his representative
  - i. Number and title of appropriate Specification Section and Article/ Paragraph, as appropriate
  - j. Drawing number and detail references, as appropriate
  - k. General Contractor's review stamp
  - l. Area for Architect's review comments

#### **1.4 SUBMITTAL SCHEDULE:**

- A. The General Contractor shall prepare and submit to the Architect prior to the Date of Commencement a schedule of Shop Drawings and Submittals as required in the Contract Documents. Schedule shall fix dates for submission, and the lead time for each submittal as related to requirements for return receipt for submittal to expedite delivery of material to maintain Progress Schedule. It is to be understood that this Schedule will be subject to change from time to time in accordance with the progress of the work.
- B. Coordinate submittal schedule with the list of subcontracts, schedule of values and the list of products as well as the General Contractor's construction schedule.
- C. Submittal log shall be updated by the General Contractor monthly until all submittals are approved by the Architect and related Consultants.

#### **1.5 STAFF NAMES:**

- A. Within ten (10) days after the Notice to Proceed, submit a list of the General Contractor's principal staff assignments, including the Project Manager, Superintendent and other personnel in attendance at the site; identify individuals, their duties and responsibilities; list their addresses and telephone numbers (including emergency telephone numbers).

#### **1.6 LIST OF SUBCONTRACTORS:**

- A. The list of subcontractors required shall be submitted to the Architect no later than ten (10) days from the Date of Commencement. This list shall include the names of manufacturers, material suppliers, and installers proposed for each of the products, equipment, and materials to be incorporated into this project.
- B. The General Contractor shall furnish upon request adequate data on any named entity on the list in order to permit the Architect and Owner to conduct a proper evaluation. Failure to object to a manufacturer shall not constitute a waiver of any of the requirements of the Contract Documents, and all products furnished by the listed manufacturer must conform to such requirements.

#### **1.7 SHOP DRAWINGS:**

- A. General:
  - 1. Each submittal shall be complete with a "Submittal Data" sheet completely filled out with all requested information including the General Contractor's stamp. A sample "Submittal Data" sheet is included at the end of this section.
  - 2. All submittals shall be dated and shall contain the project name; description or names of equipment; materials or equipment which are to be installed, reference to the Section of Specifications where it is specified and Drawing number where shown.
- B. Shop Drawings:
  - 1. Submit legible, reproducible prints of each drawing. Each drawing shall have a clear space for stamps. When phrase "by others" appears on Shop Drawings, General Contractor shall indicate on drawing who is to furnish material or operations so marked before submittal. When Shop Drawings are checked "resubmit", or words of like meaning, General Contractor shall correct and submit new reproducible prints for approval to the Architect. After completion of checking of each submission of Shop Drawings, the Architect will return prints to General Contractor. For use of all trades, the General Contractor shall provide such numbers of prints as are required for field distribution.
  - 2. General Contractor shall review and approve submittals prior to submission to Architect.

Failure to do so may result in return of submittal to General Contractor without Architect's review.

3. By approving and submitting Shop Drawings, Product Data, Samples and similar submittals, General Contractor represents that he has determined and verified materials, field measurements and field construction criteria related thereto, or will do so, and has checked and coordinated the information contained within such submittals with the requirements of the Work and the Contract Documents.
4. The responsibility for coordinating the Shop Drawings including technical data, capability (warranted and implied), sizing, color, texture, etc. shall be the sole responsibility of the General Contractor. The coordination between subcontractor and/ or material supplier shall be the responsibility of the General Contractor. The Project Coordinator shall be responsible to supervise this activity.
5. The Architect will review each of the General Contractor's submittals one initial time and, should resubmittal be required, one additional time to verify that the reasons for resubmittal have been addressed by the General Contractor and corrections made. Should additional resubmittals be required, the General Contractor shall reimburse the Owner for all costs incurred including the cost of the Architect's services made necessary to review such additional resubmittals.

C. Sheet Size:

1. Submit Shop Drawings on sheets 30" x 42" or 24" x 36".
2. HANO copy of approved shop drawings shall be on 11"x17" and in PDF on flash 23 drives(s). Flash drive(s) shall be labeled: GUSTE III UPGRADES - SHOP DRAWINGS.

**1.8 SAMPLES:**

- A. Unless otherwise specifically directed by the Architect, all Samples shall be of the precise article proposed to be furnished.
- B. Where variation in color, pattern, texture or other characteristics are inherent in the material or product represented, submit multiple units (not less than 3), that show approximate limits of the variations.
- C. Refer to Specifications for requirements for Samples that illustrate workmanship, fabrication techniques, details of assembly, connections, operation and similar construction characteristics.
- D. Submit all Samples in the quantity which is required to be returned plus one which will be retained by the Architect.

**1.9 DELIVERABLES OF SUBMITTALS:**

- A. Submit to HANO shall receive one (1) hard copy and one (1) electronic copy in PDF on flash drive(s) of all "Approved" submittals. Flash drive(s) shall be labeled: GUSTE III UPGRADES - SHOP DRAWINGS..

**PART 2 – PRODUCTS**

Not applicable

**PART 3 – EXECUTION**

Not applicable

SEE SAMPLE SUBMITTAL DATA SHEET NEXT PAGE

**END OF SECTION \_\_\_\_\_**

**SUBMITTAL DATA**

SUBMITTAL DATE:

NAME OF PROJECT:

OWNER:

ARCHITECT:

CONTRACTOR:

SUBCONTRACTOR:

SUPPLIER/ MANUFACTURER:

SPECIFICATION DIVISION NO.:

SPECIFICATION PARAGRAPH NO.:

DRAWING REFERENCE: CONTRACTOR'S

APPROVAL STAMP:

## **SECTION 01315**

### **PROGRESS SCHEDULES**

#### **PART 1 – GENERAL**

##### **1.1 GENERAL:**

- A. This specification Section is intended to augment the provisions of Division 0 documents. The specific requirements of those documents shall supersede in the event of direct conflict with any provision of this specification Section as stated herein.

##### **1.2 DESCRIPTION OF WORK:**

- A. Work Specified In This Section:
  - 1. This Section specifies administrative and procedural requirements for the progress schedules and reporting progress of the Work.
- B. Refer to General Conditions and the Agreement, for definitions and specific dates of Contract Time.

##### **1.3 RELATED WORK:**

- A. Division 0 – General Conditions of the Contract
- B. Division 0 – Supplementary General Conditions

##### **1.4 QUALITY ASSURANCE:**

- A. The General Contractor as “Project Coordinator” shall provide the progress scheduling services, including planning evaluating and reporting.
- B. General Contractor shall deliver the schedules to the Architect within 48 hours of request.

##### **1.5 PROGRESS SCHEDULE:**

- A. Schedule Format:
  - 1. Network Analysis Schedule (NAS):
    - a. Schedule method requested for use with Large/ Complex projects.
    - b. Construction Progress Schedule, utilizing a Critical Path Method (CPM) of scheduling, shall be detailed to a degree which will permit proper and complete coordination of all trades in each portion of the work. Therefore, the schedule shall specifically indicate dates in accordance with General Conditions, which shall include, but is not limited to the following:
      - 1) Date of Notice To Proceed
      - 2) Dates of major activities critical for other work
      - 3) Dates scheduled for delivery of major items of equipment
      - 4) Dates scheduled for completion of installation of major items of equipment
      - 5) The anticipated date of Substantial Completion
      - 6) The date of Substantial Completion of the project, as established by the Contract
      - 7) The date of Final Completion of the project, as established by the Contract

2. Bar Chart Schedule:

- a. Schedule method requested for use with Small projects or as approved by Architect.
- b. Construction project schedule, utilizing a Bar Chart method of scheduling, shall be detailed to a degree which will permit proper and complete coordination of all trades in each portion of the work. Therefore, the schedule shall specifically indicate dates in accordance with General Conditions, which shall include, but is not limited to the following:
  - 1) Date of Notice To Proceed
  - 2) Dates of major activities critical for other work
  - 3) Dates scheduled for delivery of major items of equipment
  - 4) Dates scheduled for completion of installation of major items of equipment
  - 5) The anticipated date of Substantial Completion
  - 6) The date of Substantial Completion of the project, as established by the Contract
  - 7) The date of Final Completion of the project, as established by the Contract

A. Phasing:

1. Provide notations on the schedule to show how the sequence of the Work is affected by requirements for phased completion to permit Work by separate Contractors and partial occupancy by the Owner prior to Substantial Completion.

C. Format:

1. Display the full network or bar chart on opaque prints of sufficient width to show data clearly for the entire construction period. Prints shall be a maximum of 11" x 17" for reproducibility.
2. Mark the critical path. Locate the critical path near the center of the network/ chart; locate paths with the most float near the edges.
3. Sub networks on separate sheets are permissible for activities clearly off the critical path.

D. Schedule Updating:

1. Revise the schedule immediately after each meeting or other activity, where revisions have been recognized or made including all approved CPR's.

**PART 2 – PRODUCTS**

Not Applicable

**PART 3 – EXECUTION**

Not Applicable

**END OF SECTION**

# **SECTION 01700 - PROJECT CLOSEOUT**

## **PROJECT CLOSEOUT**

### **PART 1 – GENERAL**

#### **1.1 DESCRIPTION OF WORK:**

##### A. Work Included in This Section:

1. This Section specifies administrative and procedural requirements for project closeout, including, but not limited to, the following:
  - a. Inspection procedures
  - b. Project record document submittal
  - c. Operating and maintenance manual submittal
  - d. Submittal of warranties
2. Closeout requirements for specific construction activities are included in the appropriate Sections.

#### **1.2 RELATED WORK:**

- A. Division 0 – General Conditions of the Contract
- B. Division 0 – HUD General Conditions (Form 5370) and Supplemental Conditions
- C. Division 0 – Special Conditions
- D. Section 01300 - Submittals

#### **1.3 SUBSTANTIAL COMPLETION:**

##### A. General:

- <sup>1</sup> 1. The Work will only be considered suitable for Substantial Completion when all work indicated in the bid documents is complete. The project shall be complete in its entirety.
2. Upon Substantial Completion of the Work and upon application by the General Contractor and recommendation by the Architect, the Owner shall make payment, reflecting adjustment in retainage, if any, for such Work or portion thereof as provided in the Contract Documents.



B. Forms:

1. All forms to be used shall be American Institute of Architect (AIA) forms, unless noted otherwise.

C. Preliminary Procedures: Before requesting inspection for certification of Substantial Completion, complete the following. List exceptions in the request.

1. The General Contractor considers the Work, or a portion thereof which the Owner agrees to with no separation, is substantially complete, the General Contractor shall prepare and submit to the Architect a comprehensive list of items to be completed or corrected prior to final payment. Failure to include an item on such list does not alter the responsibility of the General Contractor to complete all Work in accordance with the Bidding and Contract Documents.
2. Advise Owner of pending insurance change-over requirements and submit consent of surety.
3. Submit specific warranties, workmanship bonds, maintenance agreements, final certifications and similar documents.
4. Obtain and submit releases enabling the Owner unrestricted use of the Work and access to services and utilities; include occupancy permits, operating certificates and similar releases.
5. Deliver tools, spare parts, extra stock, and similar items.
6. Complete start-up testing of systems, and instruction of the Owner's operating and maintenance personnel. Discontinue or change over and remove temporary facilities from the site, along with construction tools, mock-ups, and similar elements.
7. Remove temporary facilities, construction equipment and temporary services. Restore disturbed items to original condition or better.
8. Complete final cleanup requirements, including touch-up painting. Touch-up and otherwise repair and restore marred exposed finishes.
9. Submit an acceptable copy of the HVAC Test and Balance Reports (if applicable).
10. Submit all Final Inspections Certificates along with a Use and Occupancy Certificate.

D. Inspection Procedures: Due to portions of the Work being performed within occupied residential units, inspections for partial substantial completion will be performed at the completion of Work in each unit.

1. On receipt of a request for inspection for Substantial Completion, the Architect will either proceed with inspection or advise the General Contractor of unfilled requirements. The Architect will prepare the Certificate of Substantial Completion following inspection or advise the General Contractor of construction that must be completed or corrected before the certificate will be issued.
2. The Architect will repeat inspection when requested in writing by the General Contractor and assured that the Work has been substantially completed and all items that were incomplete have been corrected.
3. Results of the completed inspection will form the basis of requirements for final acceptance.

E. Re-inspection Procedure:

1. In the event that more than the two inspections by the Architect described above are made necessary by the failure of the General Contractor to complete the Work, or to complete or correct items identified on the list of such items, the General Contractor shall reimburse the Owner for all costs incurred including the cost of the Architect's services made necessary thereby.
2. Upon completion of re-inspection, the Architect will prepare a Partial Certificate of Substantial Completion and a final Certificate of Substantial Completion at the end of the

Work, or advise the General Contractor of Work that is incomplete or of obligations that have not been fulfilled but are required for Substantial Completion.

#### **1.4 FINAL ACCEPTANCE:**

- A. At the completion of the Project prior to receiving final payment, the General Contractor shall furnish the Owner, through the Architect, properly signed and notarized waivers of lien from all subcontractors employed and material suppliers furnishing materials for the Project. Such waivers shall be submitted before final payment will be certified by the Architect to the Owner (AIA G706A). Also, at the completion of the contract, the General Contractor shall provide documentation for the signature of the Owner and General Contractor signifying the completion of the contractual obligation and the cancellation of the contract. This documentation shall be filed by the Contractor with the Recorder of Mortgages and proof of contract cancellation provided to the Owner. Upon completion of these items, final payment shall be due to the General Contractor.
- B. Preliminary Procedures:
  - 1. Before requesting final inspection for final payment, complete the following (list exceptions in the request):
    - a. Submit a copy of the Architect's final inspection list of items to be completed or corrected, stating that each item has been completed or otherwise resolved for acceptance (by initialing each individual item), and the list has been endorsed and dated by the Architect
    - b. Submit record drawings, maintenance manuals, final project photographs, and similar final record information
    - c. Submit Consent of Surety to Final Payment (AIA G707)
    - d. Submit evidence of final, continuing insurance coverage complying with insurance requirements
    - e. Guarantees, Warranties and Bonds
    - f. Spare parts and Maintenance Materials
    - g. Certificate of Insurance for Products and Completed Operations
    - h. Certificate of Occupancy, if required
    - i. All remnants required by the Contract Documents
    - j. Any other items as required by the Architect and/ or Owner

#### **1.5 RECORD DOCUMENT SUBMITTALS:**

- A. General:
  - 1. The General Contractor shall record on the Record Drawings maintained at the site all changes and selections made during construction and shall locate by dimensions showing actual field measurements of all major items which will be concealed in the completed work. These items shall include location of piping repaired or replaced and items above hard ceilings such as repairs of ducts, piping, etc.
  - 2. Dimensions are to be taken from face of building lines to centerline of piping or conduit.
  - 3. Do not use record documents for construction purposes; protect from deterioration and loss in a secure, fire-resistive location; provide access to record documents for the Architect's reference during normal working hours.
- B. Record Drawings:

1. Provide one (1) print copy of record drawings.
2. Record drawings shall be provided in the form of reproducible drawing sheets (reproducible bond) and reflect changes in the work and locations of concealed items for all trades including plumbing, mechanical, electrical and general construction. Bond prints of the original contract documents may be purchased from the Architect at the Architect's standard printing rate.
3. Mark the set to show the actual installation where the installation varies substantially from the Work as originally shown.
4. Mark whichever drawing is most capable of showing conditions fully and accurately; where Shop Drawings are used, record a cross-reference at the corresponding location on the Contract Drawings. Give particular attention to concealed elements that would be difficult to measure and record at a later date.
5. Mark new information that is important to the Owner, but was not shown on Contract Drawings or Shop Drawings.
6. Note related Change Order numbers where applicable.

C. Record Specifications:

1. Maintain one (1) complete copy of the Project Manual, including addenda, and one (1) copy of other written construction documents such as Change Orders and modifications issued in printed form during construction. Mark these documents to show variations in actual Work performed in comparison with the text of the Specifications and modifications.
2. Give particular attention to substitutions, selection of options and similar information on elements that are concealed or cannot otherwise be readily discerned later by direct observation. Note related record drawing information and Product Data.
3. Upon completion of the Work, submit record Specifications to the Architect for the Owner's records.

D. Shop Drawings:

1. Provide one (1) print copy of reviewed shop drawings (include all review comments from Architect and Consultants).
2. Deliver General Contractor's approved copy of all shop drawings submitted during the course of the project.

E. Miscellaneous Record Submittals:

1. Refer to other Specification Sections for requirements of miscellaneous record-keeping and submittals in connection with actual performance of the Work. Immediately prior to the date or dates of Substantial Completion, complete miscellaneous records and place in good order, properly identified and bound or filed, ready for continued use and reference. Submit to the Architect for the Owner's records.

F. Electronic Record Documents:

1. Provide three (3) copies of electronic version on flash or thumb drive of sufficient capacity including record drawings, record specifications, shop drawings, miscellaneous record submittals, maintenance manuals, instructions, and warranties.

## **1.6 MAINTENANCE MANUAL AND INSTRUCTIONS:**

- A. General Contractor shall, prior to completion of Contract, deliver to the Architect three (3) copies of a manual, assembled, indexed, and bound; presenting for the Owner's guidance, full details for care and maintenance of mechanical, electrical, and other equipment included in Contract.

Manuals shall include parts lists for each item of equipment furnished under the Contract.

- B. General Contractor shall, for this manual, obtain from Subcontractors, literature of manufacturers relating to equipment, including motors; also furnish cuts, wiring diagrams, instruction sheets, and other information pertaining to same that will be useful to Owner in overall operation and maintenance. Include also, the name, address, and phone number of the nearest sales and service organization for each item.

C. General:

1. Organize each manual into separate Sections for each piece of related equipment.
2. Index all data as per the Table of Contents.
3. As a minimum each manual shall contain a title page, a table of contents, copies of Product Data, supplemented by drawings and written text, and copies of each warranty, bond and service Contract issued.

D. Binders:

1. Identify each binder on the front and spine, with the typed or printed title "OPERATION AND MAINTENANCE MANUAL", Project title or name, and subject matter covered. Indicate the volume number for multiple volume sets of manuals.
2. The binders shall be hard-cover, three-ring notebook, embossed with the name of the project, spring-lock metal label holders, and piano hinge edges, (2" capacity) 11" x 8-1/2" with heavy duty rings. Provide the number of binders required to properly contain all information required.

E. Drawings:

1. Where drawings or diagrams are required as part of the manual, provide reinforced punched binder tabs on the drawings and bind in with the text.
2. Where oversize drawings are necessary, fold the drawings to the same size as the text pages and use as a fold-out.
3. If drawings are too large to be used practically as a fold-out, place the drawing, neatly folded, in the front or rear pocket of the binder. Insert a typewritten page indicating the drawing title, description of contents and drawing location at the appropriate location in the manual.

F. Protective Plastic Jackets:

1. Provide protective transparent plastic jackets designed to enclose diagnostic software for computerized electronic equipment if required.

G. Text Material:

1. Where written material is required as part of the manual use the manufacturer's standard printed material, or if it is not available, specially prepared data, neatly typewritten, on 8-1/2" by 11", 20 pound white bond paper.
2. Such data called for under separate Sections of the Specifications, shall be included in the manual described in this Section.

H. Title Page:

1. Provide a title page in a transparent plastic envelope as the first sheet of each manual. Provide the following information:
  - a. Subject matter covered by the manual

- b. Name and address of the Project
- c. Date of submittal
- d. Name, address, and telephone number of the Contractor
- e. Name and address of the Architect
- f. Cross reference to related systems in other operating and maintenance manuals

I. Table of Contents:

1. After the Title Page, include a typewritten table of contents for each volume, arranged systematically according to the Project Manual format. Include a list of each product included, identified by product name or other appropriate identifying symbol and indexed to the content of the volume.
2. Where more than one volume is required to accommodate data for a particular system, provide a comprehensive table of contents for all volumes in each volume of the set.

J. General Information:

1. Provide a general information Section immediately following the Table of Contents, listing each product included in the manual, identified by product name. Under each product, list the name, address, and telephone number of the Subcontractor or installer, and the maintenance contractor. Clearly delineate the extent of responsibility of each of these entities. In addition, list a local source for replacement parts and equipment.

K. Product Data:

1. Where manufacturer's standard printed data is included in the manuals, include only sheets that are pertinent to the part or product installed. Mark each sheet to identify each part or product included in the installation. Where more than one item in a tabular format is included, identify each item, using appropriate references from the Contract Documents. Identify data that is applicable to the installation and delete references to information that is not applicable.

L. Written Text:

1. Where manufacturer's standard printed data is not available, and information is necessary for proper operation and maintenance of equipment or systems, or it is necessary to provide additional information to supplement data included in the manual, prepare written text to provide necessary information. Organize the text in a consistent format under separate headings for different procedures. Where necessary, provide a logical sequence of instruction for each operating or maintenance procedure.

M. Warranties, Bonds and Service Contracts:

1. Provide a copy of each warranty, bond or service contract in the appropriate manual for the information of the Owner's operating personnel. Provide written data outlining procedures to be followed in the event of product failure. List circumstances and conditions that would affect validity of the warranty or bond.

1.7 **INSTRUCTIONS:**

- A. The Owner's delegated representative shall be given personal instructions by trained personnel, in the care, use, maintenance, and operation procedures for each item. This shall be done in accordance with, and in addition to, the above required manual.

B. Operating and Maintenance Instructions:

1. Arrange for each installer of equipment that requires regular maintenance to meet with the Owner's personnel to provide instruction in proper operation and maintenance. If installers are not experienced in procedures, provide instruction by manufacturer's representatives. Include a detailed review of the following items:

- a. Maintenance manuals
- b. Record documents
- c. Spare parts and materials
- d. Tools
- e. Identification systems
- f. Control sequences

2. As part of instruction for operating equipment, demonstrate the following procedures:

- a. Start-up
- b. Shutdown
- c. Emergency operations
- d. Noise and vibration adjustments
- e. Safety procedures
- f. Economy and efficiency adjustments
- g. Effective energy utilization

C. Maintenance Procedures:

1. Provide information detailing essential maintenance procedures, including the following:

- a. Routine operations
- b. Trouble-shooting guide
- c. Disassembly, repair and reassembly
- d. Alignment, adjusting and checking

D. Operating Procedures:

1. Provide information on equipment and system operating procedures, including the following:

- a. Start-up procedures
- b. Equipment or system break-in
- c. Routine and normal operating instructions
- d. Regulation and control procedures

- e. Instructions on stopping
  - f. Shut-down and emergency instructions
  - g. Summer and winter operating instructions
  - h. Required sequences for electric or electronic systems
  - i. Special operating instructions
- E. Servicing Schedule:
- 1. Provide a schedule of routine servicing and lubrication requirements, including a list of repaired lubricants for equipment with moving parts.
- F. Controls:
- 1. Provide a description of the sequence of operation and as-installed control diagrams by the control manufacturer for systems requiring controls.
- G. Coordination Drawings:
- 1. Provide each Contractor's Coordination Drawings.
  - 2. Provide as-installed color-coded piping diagrams, where required for identification.
- H. Valve Tags:
- 1. Provide charts of valve tag numbers, with the location and function of each valve.

## **PART 2 – PRODUCTS**

Not Applicable

## **PART 3 – EXECUTION**

Not Applicable

**END OF SECTION**

# **TECHNICAL SPECIFICATIONS**



## **SECTION 02220**

### **SELECTIVE DEMOLITION**

#### **PART 1 – GENERAL**

##### **1.1 RELATED DOCUMENTS**

- A. Drawings and general provisions of the contract, including General and Supplementary Conditions and Division 1 Specification Sections, apply to this section.

##### **1.2 SUMMARY**

###### A. Selective Demolition

1. Remove gypsum board at of the ceilings and walls as indicated in the drawings as required for the work.
2. Remove area of the existing finishes as required to perform the work. Where possible reuse the existing pieces. Where not possible, provide replacement pieces matching the existing as close as possible.
3. Remove to reinstall plumbing fixtures where required.
4. Remove to reinstall toilet accessories where indicated.
5. Relocate existing outlets where required.
6. Remove cabinetry where indicated. Cabinetry to remain shall be protected from damage.

- B. Extent of demolition is indicated on drawings and specified herein.

##### **1.3 SUBMITTALS**

- A. Schedule: Submit for approval selective demolition schedule, including schedule and methods for maintaining facility security at all times.

##### **1.4 QUALITY ASSURANCE**

- A. Comply with governing codes and regulations. Use experienced workers.

##### **1.5 PROJECT CONDITIONS**

- A. In general, the residential units will remain occupied throughout the Work unless the selective demolition reveals extensive remedial work. Should that occur, HANO will provide for relocation of the tenants.
- B. Provide not less than 72 hours notice of activities that will be interrupted during the course of this work.

- C. Maintain access to existing corridors, drives, walkways, exits, etc.

**PART 2 – PRODUCTS** – Not Applicable to This Section

**PART 3 – EXECUTION**

**3.1 PROTECTION**

- A. Protect all building components and contents from damage indicated to remain.
- B. General Contractor shall provide for the proper protection of all persons, property, landscaping, building elements, utilities, etc., both onsite and offsite, in accordance with requirements of these specifications and all prevailing codes and ordinances.
- C. Take all precautions to protect users of site from demolition procedures. Install barriers, fences, partitions, covered passageways, etc. as required to protect on and off-site occupants and to prevent entry of unauthorized persons into the work area.
- D. Provide adequate protection against trespassing. Secure project after work hours.

**3.2 DEMOLITION**

- A. Do not damage materials indicated to remain.
- B. Do not close or obstruct streets, walks, drives or other occupied or used spaces or facilities without the written permission of the Owner and the authorities having jurisdiction. Do not interrupt utilities serving occupied or used facilities without the written permission of the Owner and authorities having jurisdiction. If necessary, provide temporary utilities.

**3.3 DUST CONTROL**

- A. Provide all measures as necessary to prevent movement of airborne dust into adjacent buildings, spaces, hvac systems, and nearby properties. Full clean-up of spaces affected by demolition shall be done by General Contractor's forces on a daily basis before start of business day.
- B. Building interiors and exterior concrete surfaces affected by dust generated by this project (sidewalks, drives parking areas, etc.) shall be maintained in a broom clean condition.

**3.4 SHORING AND BRACING**

- A. When working in and around existing buildings, the design, installation, use and removal of temporary shoring and bracing for existing and new walls, floors, structure, etc. shall be the sole responsibility of the General Contractor, who is also responsible for project sequencing, construction methods and techniques, etc. Project sequencing shall be coordinated with the Owner.

**END OF SECTION**

**SECTION 05 50 00 - METAL FABRICATIONS**

**PART 1 - GENERAL**

**1.1 RELATED DOCUMENTS**

- A. Drawings, General Conditions of the Contract for Construction, Supplementary Conditions of the Contract for Construction including Specification Sections, apply to this Section.

**1.2 SUMMARY**

- A. This section includes the following:
  - 1. Shop fabricated ferrous metal items with prime painted finish.
  - 2. Refer to Schedule at end of this Section.

**1.3 REFERENCES**

- A. ASTM A36 - Carbon Steel.
- B. ASTM A307 - Low-Carbon Steel Externally and Internally Threaded Fasteners.
- C. ASTM A325 - High Strength Bolts for Structural Steel Joints.
- D. AWS D1.1 - Structural Welding Code.
- E. FSTT-P-636 – Primer Coating, Alkyd, Wood, and Ferrous Metal.

**1.4 SUBMITTALS**

- A. Submit shop drawings under provisions of Section 01330.
- B. Indicate profiles, sizes, spacing, and locations of structural members, connections, attachments, fasteners, and cambers.
- C. Indicate welded connections using standard AWS welding symbols.

**PART 2 - PRODUCTS**

**2.1 MATERIALS**

- A. Steel Plates, Shapes, and Sections: ASTM A36.
- B. Bolts, Nuts, and Washers: ASTM A307 and A325.
- C. Welding Materials: AWS D1.1; type required E70XX or better for materials being welded.

**HOUSING AUTHORITY OF NEW ORLEANS  
BALCONY ALTERATIONS AT THE  
GUSTE III HOUSING COMMUNITY, BUILDING M**

**December 12, 2022  
Architect's Proj. #22-013**

- D. Hot-Dip Galvanizing of Steel: ASTM A653.
- E. Shop Coat Paint: Red Oxide Alkyd.

**2.2 PRIMER**

- A. Primer: Fabricator's standard lead and chromate-free, non- asphaltic, rust-inhibiting primer.

**2.3 FABRICATION**

- A. Verify dimensions on site prior to shop fabrication.
- B. Fabricate items with joints tightly fitted and secured.
- C. Fit and shop assemble in largest practical sections, for delivery to site.
- D. Grind exposed welds flush and smooth with adjacent finished surface.
- E. Exposed Mechanical Fastenings: Flush countersunk screws or bolts; unobtrusively located; consistent with design of structure, except where specifically noted otherwise.
- F. Make exposed joints butt tight, flush, and hairline.
- G. Supply components required for anchorage of metal fabrications. Fabricate anchorage and related components of same material and finish as metal fabrication, except where specifically noted otherwise.

**2.4 FINISH**

- A. Clean surfaces of rust, scale, grease, and foreign matter prior to finishing.
- B. Do not shop prime surfaces in direct contact with concrete or where field welding is required.
- C. Shop prime surfaces. Paint with lead bearing compounds are prohibited.

**PART 3 - EXECUTION**

**3.1 PREPARATION**

- A. Obtain Architect approval prior to site cutting or making adjustments not scheduled.
- B. Clean and strip site primed steel items to bare metal where site welding is scheduled.

**HOUSING AUTHORITY OF NEW ORLEANS  
BALCONY ALTERATIONS AT THE  
GUSTE III HOUSING COMMUNITY, BUILDING M**

**December 12, 2022  
Architect's Proj. #22-013**

- C. Make provision for erection loads with temporary bracing. Keep work in alignment.

**3.2 INSTALLATION**

- A. Install items plumb and level, accurately fitted, free from distortion or defects.
- B. Perform field welding in accordance with AWS D1.1.
- C. After installation, touch-up field welds, scratched or damaged surfaces with red oxide alkyd primer.

**END OF SECTION 05 50 00**

**SECTION 06 05 74 – PRESERVATIVE TREATED WOOD**

**PART 1 - GENERAL**

**1.1 RELATED DOCUMENTS**

- A. Drawings, General Conditions of the Contract for Construction, Supplementary Conditions of the Contract for Construction, including Specification Sections, apply to this Section.

**1.2 SUMMARY**

- A. This Section includes the following:
  - 1. Preservative treated wood dimension lumber for use as sleepers to support new decking.
  - 2. Fasteners, hot-dipped galvanized finish.

**1.3 REFERENCES**

- A. ASTM A307 – Low carbon steel externally and internally threaded fasteners.
- B. ASTM A653 – Hot-dip galvanizing of steel.

**1.4 SUBMITTALS**

- A. Submit product data under the provisions of Section 01330.
- B. Wood treatment data as follows, including chemical treatment manufacturer's instructions for handling, storing, installing, and finishing treated materials:
  - 1. For each type of preservative-treated wood product, include certification by treating plant stating type of preservative solution and pressure process used, net amount of preservative retained, and compliance with applicable standards.
- C. Material test reports from a qualified independent testing agency indicating and interpreting test results relative to compliance of fire-retardant-treated wood products with performance requirements indicated.
- D. Warranty of chemical treatment manufacturer for each type of treatment.

**1.5 DELIVERY, STORAGE, AND HANDLING**

- A. Keep materials under cover and dry. Protect from weather and contact with damp or wet surfaces. Stack lumber and provide for air circulation within and around stacks and under temporary coverings.

1. For lumber and plywood preservative pressure treated with waterborne chemicals, place spacers between each bundle to provide air circulation.

## **PART 2 - PRODUCTS**

### **2.1 LUMBER, GENERAL**

- A. Lumber Standards: Comply with DOC PS 20, "American Softwood Lumber Standard," and with applicable grading rules of inspection agencies certified by American Lumber Standards Committee's (ALSC) Board of Review.
- B. Inspection Agencies: Inspection agencies, and the abbreviations used to reference them, include the following:
- C. Grade Stamps: Provide lumber with each piece factory marked with grade stamp of inspection agency evidencing compliance with grading rule requirements and identifying grading agency, grade, species, moisture content at time of surfacing, and mill.
  1. For exposed lumber, furnish pieces with grade stamps applied to ends or back of each piece.
- D. Where nominal sizes are indicated, provide actual sizes required by DOC PS 20 for moisture content specified. Where actual sizes are indicated, they are minimum dressed sizes for dry lumber.
  1. Provide Structural No. 1 grade lumber, free of knots.
  2. Provide dressed lumber, S4S, unless otherwise indicated.
  3. Provide dry lumber with 19 percent maximum moisture content at time of dressing for 4-inch nominal thickness or less, unless otherwise indicated.

### **2.2 PRESERVATIVE TREATED WOOD MATERIALS**

- A. General: Where lumber is indicated as preservative treated or is specified to be treated, comply with applicable requirements of AWPA C2 (lumber). Mark each treated item with the Quality Mark Requirements of an inspection agency approved by ALSC's Board of Review.
  1. Do not use chemicals containing chromium or arsenic.
  2. For exposed items indicated to receive stained finish, use chemical formulations that do not bleed through, contain colorants, or otherwise adversely affect finishes.
  3. Waterborne Preservative Chemicals: Acceptable to authorities having jurisdiction and the following:
    - a) Alkaline Copper Quat-Type C (ACQ-C).

**HOUSING AUTHORITY OF NEW ORLEANS  
BALCONY ALTERATIONS AT THE  
GUSTE III HOUSING COMMUNITY, BUILDING M**

**December 12, 2022  
Architect's Proj. #22-013**

- b) Copper Azole – Type A (CBA-A).
- c) Amine Copper Quat – Type D (ACQ-D).

B. Pressure treat above ground items with preservatives to a minimum retention of 0.25 lb/cu. ft. After treatment, kiln-dry lumber to a maximum moisture content of 19 percent.

**2.3 DIMENSION LUMBER**

A. General: Provide dimension lumber of grades indicated according to the ALSC National Grading Rule (NGR) provisions of the inspection agency indicated. Provide treated dimension lumber with 19 percent maximum moisture content and the following species and grade:

- 1. Grade: No. 1, Structural, free of knots.
- 2. Species: Southern Yellow Pine (SYP).

**2.4 FASTENERS**

A. General: Provide fasteners of size and type indicated that comply with requirements specified in this Article for material and manufacture.

B. Bolts: Steel bolts complying with ASTM A 307, Grade A (ASTM F 568, Property Class 4.6); with ASTM A 563 (ASTM A 563M) hex nuts and, where indicated, flat washers, hot-dip galvanized finish per ASTM A653. Hot-dip galvanize items to a minimum 1.25 oz./sq. ft. zinc coating.

**PART 3 - EXECUTION**

**3.1 INSTALLATION, GENERAL**

A. Discard units of material with defects that impair quality of carpentry and that are too small to use with minimum number of joints or optimum joint arrangement.

B. Set carpentry to required levels and lines, with members plumb, true to line, cut, and fitted.

C. Fit carpentry to other construction; scribe and cope as required for accurate fit. Correlate location of furring, nailers, blocking, grounds, and similar supports to allow attachment of other construction.

D. Securely attach carpentry work as indicated and according to applicable codes and recognized standards.

**3.2 WOOD SLEEPERS (SUPPORT FRAMING)**



**HOUSING AUTHORITY OF NEW ORLEANS  
BALCONY ALTERATIONS AT THE  
GUSTE III HOUSING COMMUNITY, BUILDING M**

**December 12, 2022  
Architect's Proj. #22-013**

- A. Install where shown and where required for attaching other work. Cut, shape, and fit to required size and porch flooring slope. Coordinate locations with other work involved.
- B. Attach to substrates to support applied loading. Space sleepers a maximum of sixteen inches on-center.

**END OF SECTION 06 05 74**

## **SECTION 06100**

### **ROUGH CARPENTRY**

#### **PART 1 - GENERAL**

##### **1.01 RELATED DOCUMENTS**

- A. The general provisions of the Contract, including General and Supplementary Conditions of the Specification Sections, apply to the Work specified in this Section.

##### **1.02 SUMMARY**

- A. The work required under this Section consists of all carpentry work and related items necessary to complete the Work indicated on Drawings and/or described in Specifications.
- B. Without restricting the volume or generality of the above, the work to be performed under this Section shall include, but is not limited to the following:
  - 1. Compliance with standards and industry specifications.
  - 2. Wood blocking where indicated. Cut to fit.
  - 3. Miscellaneous other carpentry Work.

##### **1.03 REFERENCES**

- A. ALSC (American Lumber Standards Committee) - Softwood Lumber standards.
- B. AWWPA (American Wood Preservers Association) - C-1 - All timber products preservative treatment by pressure process.
- C. NFPA (National Forest Products Association).
- D. SFPA (Southern Forest Products Association)

##### **1.04 QUALITY ASSURANCE**

- A. Perform work in accordance with the following agencies.
  - 1. Lumber Grading Agency: Certified by ALSC.
- B. Wood preservative: Submit certificate stating chemical and process used, net amount of preservative retained and compliance with standard.

##### **1.05 PRODUCT DELIVERY, STORAGE, AND HANDLING**

- A. Immediately upon delivery to job site, place materials in area protected from weather.
- B. Store materials a minimum of six inches above ground on framework or blocking and cover with tarpaulins and not plastic film covering, providing for adequate air

- circulation or ventilation.
- C. Protect products from damage.
- D. Damaged products shall not be used.

## **PART 2 - PRODUCTS**

### **2.01 GRADES AND SPECIES OF WOOD**

- A. Plates, ledgers, bucks, braces, blocking shall be No. 2 grade S.Y.P.
- B. All lumber in direct contact with concrete or masonry or roofing materials shall be pressure treated.
  - 1. All pressure treated lumber, blocking, and trim called for on the Drawings or specified, shall be treated against rot, termites, etc., by a pressure process complying with AWPB C28 (Celcured or Wolmanized).
  - 2. Also treat lumber with fire retardant.
- C. Replacement lumber used for repairs shall match size and profile of existing.
- D. Plywood Sheathing
  - 1. Meet Requirements of PS 1-83/ANSI A199.1 except where APA Performance Rated units are specified. Every sheet shall bear appropriate APA grade stamp identifying species of plywood or by Certificate of Inspection issued by approved lumber grading or inspection bureau or agency listed above.
  - 2. Plywood shall not exceed 18 percent moisture content when fabricated nor more than 19 percent when installed.
  - 3. This specification is written for APA Performance Rated Plywood. In all cases, thickness shown is minimum regardless of span rating. Material used for same purpose shall be of same thickness.
  - 4. Panels shall be stamped 'Sized for Spacing'.
- E. Nails
  - 1. Up to & including 3/8 inch panel – 8d common or box.
  - 2. 15/32 inch & thicker panel – 10d common or galvanized box.
- F. Pressure Treated Wood
  - 1. Treat plywood in contact with concrete or masonry in accordance with LP 2-80 and dried after treatment.
    - a. Lumber grade and species shall be as specified for the particular use.
    - b. Identify treated lumber as to name of treater, preservative used, and retention in lbs/cu. ft.
    - c. Season after treatment to moisture content required for non-treated material.

## **2.02 MATERIALS**

- A. Lumber grading rules: NFPA, SPIB, WCLB, SFPA.
- B. Miscellaneous framing: No. 1 Southern Yellow Pine or Douglas fir species. Nineteen percent maximum moisture content, pressure preservative treated for all lumber that may be exposed to weather or moisture.

## **2.03 OTHER MATERIALS**

- A. Rough hardware, except as specified otherwise herein, shall be as required for the proper execution of the work of this Section.
- B. Non-corrosive nails shall be used for all exposed woodwork, and shall be aluminum, hot dipped galvanized steel, cadmium plated or stainless steel.

## **PART 3 - EXECUTION**

### **3.01 PROCEDURE**

- A. All blocking, etc., shall be securely nailed with nails sized not to split the material. The work shall be installed in accordance with the best carpentry practice.
- B. Provide all shoring, scaffolding, etc., necessary for the safe performance of the work.
- C. Discard units of material with defects which might impair quality of work, and units which are too small to use in fabricating work with minimum joints or optimum joint arrangement.
- D. Set carpentry work accurately to required levels and lines, with members plumb and true and accurately cut and fitted.
- E. Securely attach carpentry work to substrate by anchoring and fastening as shown and as required by recognized standards. Select fasteners of size that will not penetrate members where opposite side will be exposed to view or will receive finish material. Make tight connections between members. Install fasteners without splitting of wood; predrill as required.
- F. Wood Grounds, Nailers, Blocking and Sleepers
  - 1. Provide wherever shown and where required for screeding or attachment of other work (cabinets, etc.). Form to shapes as shown, kerf and cut as required for true line and level of work to be attached. Coordinate location with other work involved.
  - 2. Attach to substrates as required to support applied loading. Countersink bolts and nuts flush with surfaces, unless otherwise show.
  - 3. Prime all faces of new blocking prior to installation.

**END OF SECTION**

**SECTION 06 53 00 – PLASTIC FABRICATIONS**

**PART 1 - GENERAL**

**1.1 RELATED DOCUMENTS**

- A. Drawings, General Conditions of the Contract for Construction, Supplementary Conditions of the Contract for Construction, including Specification Sections, apply to this Section.

**1.2 SUMMARY**

- A. This Section includes the following:
  - 1. Balcony tongue and groove strip flooring with integral color (not painted or surface-colored). Sectional size of boards shall be a true 3 1/8 inches wide by 7/8 inch deep.

**1.3 REFERENCES**

- A. ASTM D792: Standard Test Methods for Density and Specific Gravity (Relative Density) of Plastics by Displacement.
- B. ASTM D1761: Standard Test Methods for Mechanical Fasteners in Wood.
- C. ASTM D2565: Standard Practice for Xenon-Arc Exposure of Plastics Intended for Outdoor Applications.
- D. ASTM D6109: Standard Test Methods for Flexural Properties of Unreinforced and Reinforced Plastic Lumber and Related Products.
- E. ASTM D6341: Standard Test Method for Determination of the Linear Coefficient of Thermal Expansion of Plastic Lumber and Plastic Lumber Shapes Between -30 and 1400F.
- F. ASTM D7031: Standard Guide for Evaluating Mechanical and Physical Properties of Wood-Plastic Composite Products.
- G. ASTM E84: Standard Test Method for Surface Burning Characteristics of Building Materials.

**1.4 SUBMITTALS**

- A. Submit under provisions of Section 01 30 00.

- B. Product Data: Submit Manufacturer's data sheets on each product to be used, including:
  - 1. Preparation instructions and recommendations.
  - 2. Storage and handling requirements and recommendations.
  - 3. Installation methods.
  - 4. Warranty.
- C. Verification Samples: For each product specified, two samples, minimum size six inches long, of actual product. Provide such samples (two each) for each standard color option offered by the Manufacturer.

#### 1.5 QUALITY ASSURANCE

- A. Regulatory Requirements: Comply with requirements of authorities having jurisdiction and applicable codes at the location of the project.
- B. Manufacturer Qualifications: Minimum 10 years of experience manufacturing similar products.
- C. Installer Qualifications: Minimum 2 years of experience installing similar products.
- D. Mock-Ups: Provide a mock-up for evaluation of surface preparation techniques and application workmanship.
- E. Construct area designated by Architect.
- F. Do not proceed with remaining work until workmanship is accepted by Architect.
- G. Remodel mock-up area as required to produce acceptable work.

#### 1.6 DELIVERY, STORAGE, AND HANDLING

- A. Deliver and store products in manufacturer's unopened packaging bearing the brand name and manufacturer's identification until ready for installation.
- B. Comply with manufacturer's recommendations. Handle materials to avoid damage.

#### 1.7 PROJECT CONDITIONS

- A. Maintain environmental conditions (temperature, humidity, and ventilation) within limits recommended by manufacturer for optimum

results. Do not install products under environmental conditions outside manufacturer's recommended limits.

**1.8 WARRANTY**

- A. Provide manufacturer's standard limited warranty for products, stating that components will be free from defects in material that occur as a direct result of the manufacturing process, occur under normal use and service, occur during the warranty period and result in blistering, peeling, flaking, cracking, splitting, cupping, rotting or structural defects from termites or fungal decay.
- B. Aeratis Porch Heritage Warranty:
  - 1. Limited Lifetime.

**PART 2 - PRODUCTS MANUFACTURERS**

- A. Acceptable Manufacturer: Aeratis International, PO BOX 11087; Chandler, AZ 85248; Toll Free Tel: 888-676-2683; Fax: 480-907-1124; Email:[tidwell@eratis.com](mailto:tidwell@eratis.com); Web: <https://www.aeratis.com>
- B. Requests for substitutions will be considered in accordance with provisions of Section 01 60 00 - Product Requirements.

**2.2 PORCH FLOORING CHARACTERISTICS**

- A. Thermal Characteristics: Provide products complying with the following:
- B. Flame Spread Index: Less than 76, ASTM E 84.
- C. Product Aeratis Heritage, T&G - 3-1/8" X 7/8" in sectional size:
- D. Surface Texture: Embossed Smooth both sides. (No grooves in bottom side.)
- E. Edge Profile: Tongue and groove.
- F. Color: As selected by Architect from Manufacturer's standard colors (three or more options).
- G. Trim: None.
- H. Stair and Picture Frame: Not Applicable
- I. Porch Ceiling: Not Applicable

**2.3 ACCESSORIES**

- A. Fasteners: Stainless steel, 2" ½" crown 15 gauge staple, installed with pneumatic tool and rubber hammer as per Manufacturer's instructions and recommendations.
- B. Adhesives: Construction adhesive as indicated in Section 06 10 00 – Rough Carpentry .

### **PART 3 - EXECUTION**

#### **3.1 EXECUTION EXAMINATION**

- A. Verification of Conditions:
  - 1. Examine areas and conditions under which work is to be performed and identify conditions that may be detrimental to proper or timely completion.
  - 2. Confirm that new sleepers are spaced at 16 inches on center maximum and that the tops of all sleepers at a particular balcony form a plane that is sloped 1/4 inch per foot away from the building. Adjust sleepers to correct slope if required. Do NOT install shims, strips, or any other type of spacer between sleepers and decking that are greater than one-eighth (1/8) of one inch thick. Plane or otherwise field-modify sleepers as required to achieve requirement for maximum shim thickness.

#### **3.2 INSTALLATION**

- A. General: Install products in accordance with manufacturer's instructions, approved submittals, and in proper relationship with adjacent construction.
- B. Install new balcony floor boards in one piece in the direction of slope, without joints parallel to the building face. **There shall be NO end-to-end joints between new balcony floor boards. Butt joints are NOT acceptable.**
- C. Do NOT install balcony floor boards parallel to the building face. New balcony floor boards shall be installed parallel to the existing ferrous metal balcony joists and perpendicular to the new wood sleepers.
- D. Provide Manufacturer-recommended fasteners, not more than two (2) inches from board ends with pneumatic flooring installation tool.
- E. Use urethane-based construction adhesive on the top of the sleepers. Do not allow adhesive to be visible from below or from any other viewpoint. Promptly remove any adhesive squeeze-out before adhesive dries/cures.



**HOUSING AUTHORITY OF NEW ORLEANS  
BALCONY ALTERATIONS AT THE  
GUSTE III HOUSING COMMUNITY, BUILDING M**

**December 12, 2022  
Architect's Proj. #22-013**

- F. Porch Flooring Installation (Joist span 16"OC max:
- G. Install with either side up for the walking surface. The specified Aeratis product is double-sided.
- H. Fasten tight to new sleepers. Provide solid PVC shims or if there are variations in framing. The maximum shim thickness shall be one-eighth (1/8) of one inch. See Paragraph 3.1, A. 2 above.
- I. Countersink fasteners slightly to provide necessary clearance when installing the next board.
- J. Square boards prior to installation on the end facing the structure.
- K. Provide clearance from existing exterior wall facing material as required to provide a continuous sealant joint between the new balcony floor boards and the existing wall.
- L. Cut final boards as required for proper appearance and proper overhang as indicated on the Drawings.

**3.3 PROTECTION**

- A. Protect from damage during construction operations. Promptly repair any damaged surfaces. Remove and replace work which cannot be satisfactorily repaired.
- B. Clean products, prior to Substantial Completion, using materials recommended by the manufacturer to remove stains, dirt and debris prior to final acceptance.

**END OF SECTION 06 53 00**

## **SECTION 07920**

### **JOINT SEALANTS**

#### **PART 1 - GENERAL**

##### **1.1 RELATED DOCUMENTS**

- A. Drawings and general provisions of the Contract, including General and Supplementary Conditions and Division 1 Specification Sections, apply to this Section.

##### **1.2 SECTION INCLUDES**

- A. Sealants and joint backing
- B. Precompressed foam sealers

##### **1.3 REFERENCES**

- A. ASTM C 1193 – Standard Guide for Use of Joint Sealants; 1991 (Reapproved 1995).
- B. ASTM D 1056 – Standard Specification for Flexible Cellular Materials – Sponge or Expanded Rubber; 1991.
- C. ASTM D 1667 – Standard Specification for Flexible Cellular Materials – Vinyl Chloride Polymers and Copolymers (Closed –Cell Foam); 1976 (Approved 1990).

##### **1.4 SUBMITTALS**

- A. See Section 01300 – for submittal procedures.
- B. Product Data: Provide data indicating sealant chemical characteristics.
- C. Samples: Submit samples, 3x3 inch in size illustrating sealant colors for selection.
- D. Manufacturer’s Installation Instructions: Indicate special procedures.

##### **1.5 QUALITY ASSURANCE**

- A. Manufacturer Qualifications: Company specializing in manufacturing the Products specified in this section with minimum three years experience.
- B. Applicator Qualifications: Company specializing in performing the work of this section with minimum 3 years experience.

##### **1.6 ENVIRONMENTAL REQUIREMENTS**

- A. Maintain temperature and humidity recommended by the sealant manufacturer during and after installation.

## **1.7 COORDINATION**

- A. Coordinate the work with all sections referencing this section.

## **PART 2 – PRODUCTS**

### **2.1 MANUFACTURERS**

- A. Silicone Sealants:
  - 1. Dow Corning Corp. #795.
  - 2. GE Silicones
  
- B. Polyurethane Sealants:
  - 1. Pecora Corp.
  - 2. Sikaflex – La, Sika Corp.
  - 3. Sonolastic NPI, Sonneborn-Contech, Inc.
  
- C. Acrylic Sealants:
  - 1. Tremco, Inc.
  
- D. Butyl Sealants:
  - 1. Bostik.
  - 2. TEC Incorporated.
  - 3. Tremco, Inc.
  
- E. Acrylic Emulsion Latex Sealants:
  - 1. Pecora Corp.
  - 2. Tremco, Inc.
  
- F. Performed Compressible Foam Sealers:
  - 1. Emseal Joint Systems, Ltd.

### **2.2 ACCESSORIES**

- A. Primer: Non –staining type, recommended by sealant manufacturer to suit application.
- B. Joint Backing: Round foam rod compatible with sealant; ASTM D 1667, closed cell PVC oversized 30 to 50 percent larger than joint width.
- C. Bond Breaker: Pressure sensitive tape recommended by sealant manufacturer to suit application.

## **PART 3 – EXECUTION**

### **3.1 EXAMINATION**

- A. Verify that substrate surfaces are ready to receive work.
- B. Verify that joint backing and release tapes are compatible with sealant.

### **3.2 PREPARATION**

- A. Remove loose materials and foreign matter which might impair adhesion of sealant.
- B. Clean and prime joints in accordance with manufacturer's instructions.
- C. Perform preparation in accordance with manufacturer's instruction and ASTM C 1193.
- D. Protect elements surrounding the work of this section from damage or disfigurement.

### **3.3 INSTALLATION**

- A. Perform work in accordance with sealant manufacturer's requirements for preparation of surfaces and material installation instructions.
- B. Perform installation in accordance with ASTM C 1193.
- C. Measure joint dimensions and size joint backers to achieve width-to-depth ratio, neck dimension, and surface bond and area as recommended by manufacturer, except where specific dimensions are indicated.
- D. Install bond breaker where joint backing is not used.
- E. Install sealant free of air pockets, foreign embedded matter, ridges, and sags.
- F. Apply sealant within recommended application temperature ranges. Consult manufacturer when sealant cannot be applied within these temperature ranges.
- G. Tool Joints concave.

### **3.4 CLEANING**

- A. Clean adjacent soiled surfaces.

### **3.5 PROTECTION OF FINISHED WORK**

- A. Protect sealants until cured.

### **3.6 SCHEDULE**

- A. Provide caulking to appropriate materials as recommended by the manufacturer.

**END OF SECTION**

## **SECTION 09250**

### **GYPSUM BOARD**

#### **PART 1 - GENERAL**

##### 1.01 RELATED DOCUMENTS

- A. Drawings and general provisions of the Contract, including General and Supplementary Conditions of the Specification Sections apply to this section.

##### 1.02 SUMMARY

- A. This Section includes the following:
  - 1. Gypsum board assemblies attached to wood framing.

##### 1.03 REFERENCES

- A. GA 201- Gypsum Board for Walls and Ceilings.
- B. GA 216- Recommended Specifications for the Application and Finishing of Gypsum Board.
- C. ANSI/ASTM C36 - Gypsum Wallboard.
- D. ANSI/ASTM C442 - Gypsum Backing Board.
- E. ANSI/ASTM C475 - Joint Treatment Materials for Gypsum Board Wallboard Construction.
- F. ANSI/ASTM C646 - Steel Drill Screws for the application of Gypsum Sheet Material to Light Gage Steel Studs.
- G. ANSI/ASTM C754 - Installation of Framing Members to receive Screw Attached Gypsum Wallboard, Backing Board, or Water Resistant Backing Board.

##### 1.04 QUALITY ASSURANCE

- A. Perform Gypsum board systems work in accordance with the recommendations of ASTM C754, GA216, and GA201 unless otherwise specified in this section.
- B. Keep copy of GA201 and in field office for the duration of the project.

##### 1.05 SUBMITTALS

- A. Submit shop drawings, product data, and manufacturer's instructions under provisions of Paragraph 6.17 of the General Conditions.

## **PART 2 – PRODUCTS**

### **2.01 ACCEPTABLE MANUFACTURERS- METAL STUDS**

- A. Clark Steel Framing Systems
  - B. Deitrich Industries, Inc.
  - C. Dale Industries, Inc.
- 1. Gypsum Board and related Products:
    - a. Georgia-Pacific Corp.
    - b. National Gypsum Co.; Gold Bond Building Products Division
    - c. United States Gypsum Co.

### **2.02 ACCESSORIES**

- A. Metal Trim for Gypsum Board:
  - 1. Conform to profile and dimensions indicated.
  - 2. Material for interior work: Galvanized steel, 26 gauge minimum.
  - 3. Corner beads: Equivalent to Dur-A-Bead No. 103 by USG.
  - 4. Casing beads (edge beads): Equivalent to 200A by USG.
  - 5. Control joints:
    - a. Roll-formed zinc with perforated flanges.
    - b. Size: 1-<sup>3</sup>/<sub>4</sub> inch wide, with <sup>1</sup>/<sub>4</sub> inch wide center channel.
    - c. Provide with removable tape strip over channel.
    - d. Acceptable product: Equivalent to No. 093 by USG.
- B. Paper-Faced Metal Trim for Gypsum Board:
  - 1. Conform to profile and dimensions indicated.
  - 2. Material for interior work: Comply with ASTM C1047.
  - 3. Outside corners: Paper Faced Metal Bead and Trim B1W series by USG.
  - 4. Outside Bullnose corners: Paper Faced Metal Bead and Trim by USG.
  - 5. Inside corners: Paper Faced Metal Bead and Trim by USG.
  - 6. Trims: L shape B4-SERIES by USG; J shape: B9 SERIES by USG.

- C. Trim for Exterior Soffits: Rolled zinc complying with ASTM C1047.
- D. Special Trim and Reveals: Extruded aluminum alloy 6063-T5, profiles as indicated.
- E. Adhesives and Joint Treatment Materials:
  - 1. Conform to requirements of ASTM C475.
  - 2. Joint compounds:
    - a. Drying-type (ready-mixed): Equivalent to SHEETROCK® brand taping joint compound and topping joint compound, or SHEETROCK® all-purpose joint compound.
    - b. SHEETROCK® brand TUFF-HIDE™ primer-surfacer: Finish Level 4 (GA-214/ASTM C-840) drywall surface with vinyl acrylic latex-based coating to achieve Level 5 gypsum board finish.
    - c. Laminating adhesive for multiple layers: Special adhesive or joint compound specifically recommended for laminating gypsum boards.
    - d. Laminating adhesive for direct application: Special adhesive or joint compound specifically recommended for laminating gypsum boards for adhering gypsum boards to solid substrates.
    - e. Reinforcing joint tape:
      - 1) ASTM C475, 2 inch nominal width.
      - 2) For backer board, provide fiberglass tape as recommended by board manufacturer and acceptable to manufacturer of ceramic tile setting materials.
    - f. Gypsum Board Screws: Self-drilling, self-tapping steel screws.
      - 1) For steel framing less than 0.03 inch thick: Comply with ASTM C1002.
      - 2) For steel framing from 0.033 inch thick to 0.112 inch thick: comply with ASTM C954.
      - 3) Provide Type S or Type S-12 screws.
    - g. Miscellaneous Accessories: Provide as required for complete installations.

## 2.03 GYPSUM BOARD PRODUCTS

- A. General: Provide gypsum board of types indicated in maximum lengths available that will minimize end- to-end butt joints in each are indicated to receive gypsum board application and in accordance with recommendations of GA216.
  - 1. Widths: Provide gypsum board in widths of 48 inches.

- B. Gypsum Wallboard: ASTM C 36 and as follows:
  - 1. Type: Regular for vertical surfaces, unless otherwise indicated.
  - 2. Edges: Tapered and featured (round or beveled) for pre filling.
  - 3. Thickness:  $\frac{5}{8}$  inch, moisture resistant type.

#### 2.04 GYPSUM BOARD ACCESSORIES

- A. Provide gypsum board accessories in accordance with GA216.
- B. Corner Beads: 1 1/4" X 1 1/4" wide X .013" Galvanized Type U.S.G. Dur-a-Bead or Gold Bond wallboard Corner Bead conforming to ASTM C1047.
- C. Edge Trim: No. 200-A metal trim by U.S.G. or No. 100 casing bead by Gold Bond.
- D. Reinforcing Tape, Joint Compound, Adhesive, Water, Fasteners: GA216.
- E. Building Paper: No. 15 asphalt saturated roofing felt.
- F. Control Joints: Zinc extrusion, Gold Bond or .093 zinc control joint of U.S.G. Sheet rock zinc control joint No. 093.

### **PART 3- EXECUTION**

#### 3.01 INSPECTION

- A. Verify that site conditions are ready to receive work and opening dimensions are as instructed by the manufacturer.
- B. Beginning of installation means acceptance of substrate.

#### 3.02 GYPSUM BOARD INSTALLATION

- A. Erect exterior gypsum sheathing horizontally, with edges butted tight and ends occurring over firm bearing.
- B. Use screws when fastening gypsum board to metal furring or framing.
- C. Treat cut edges and holes in moisture resistant gypsum board and sealant.
- D. Place control joints consistent with lines of building spaces as indicated.
- E. Place corner beads at all external corners. Use longest practical lengths. Place edge



trim where gypsum board abuts dissimilar materials and at control joints.

- F. Tape, fill, and sand exposed joints, edges, corners, openings and fixtures, to produce surface ready to receive finishes. Feather coats onto adjoining surfaces so that camber is maximum 1/32 inch.
- G. Remove and re-do defective work.

### 3.03 FINISHING

- A. Provide Level 5 finish at gypsum board surfaces throughout the project except otherwise noted.
- B. Provide Level 4 finish in all storage room areas.

#### 1. Interior Gypsum Board:

##### a. Prefill:

- 1) Use setting-type joint compound. Mix joint compound according to manufacturer's directions.
- 2) Fill joints between boards flush to top of eased or beveled edge.
- 3) Fill joints of gypsum board above suspended ceilings in fire-rated partitions.
- 4) Wipe off excess compound and allow compound to harden.

##### b. Taping (Level 1):

- 1) Use taping or all-purpose compound.
- 2) Butter taping compound into inside corners and joints.
- 3) Center tape over joints and press down into fresh compound.
- 4) Remove excess compound.
- 5) Tape joints of gypsum board above suspended ceilings.

##### c. First coat (Level 2):

- 1) Use taping or all-purpose drying-type compound, or setting-type joint compound.
- 2) Immediately after bedding tape, apply skim coat of compound over body of tape and allow to dry completely in accordance with manufacturer's instructions.
- 3) Apply first coat of compound over flanges of trim and accessories, and over exposed fastener heads and finish level with board surface.

- d. Second coat (Level 3): Use all purpose or topping (conventional weight, lightweight or midweight) drying type joint compound. After first coat treatment is dried, apply second coat of compound over tape and trim, feathering compound 2 inches beyond edge of first coat.

- e. Third coat (Level 4):
    - 1) Use all purpose or topping [conventional weight, lightweight or midweight] drying type joint compound.
    - 2) After second coat has dried, sand surface lightly and apply thin finish coat to joints, fasteners and trim, feathering compound 2 inches beyond edge of second coat.
    - 3) Allow third coat to dry. Apply additional compound, and touch-up and sand, to provide surface free of visual defects, tool marks, and ready for application of finish.
  - f. Skim coat (Level 5):
    - 1) Apply skim coat of all-purpose (conventional weight) drying-type compound or spray-applied Primer-Surfacer, TUFF\_HIDE over exposed surfaces of gypsum board.
    - 2) After skim coat has dried, touch-up and sand to provide surface free of visual defects, tool marks, and ridges, and ready for application of finish.
2. Joint Compound:
- a. After skim coat sets, apply finish coat of compound feathering 3 to 4 inches beyond tape edges.
  - b. Feather coats onto adjoining surfaces so that camber is maximum 1/32 inch.
  - c. Allow joint compound to completely set before applying veneer plaster finish.
3. Trim:
- a. Use same fasteners to anchor trim accessory flanges as required to fasten gypsum board to supports, unless otherwise recommended by trim manufacturer.
  - b. Install metal corner beads at external corners.
  - c. Install metal casing bead trim whenever edge of gypsum base would otherwise be exposed or semi-exposed, and where gypsum base terminates against dissimilar material.
4. Special Trim and Reveal Joints: Install as indicated on drawings and in accordance with manufacturer's instructions.

### 3.04 TOLERANCES

- A. Maximum Variation from True Flatness: 1/8 inch in 10 feet in any direction.

3.05 CLEANING AND PROTECTION

- A. Promptly remove any residual joint compound from adjacent surfaces.
- B. Provide final protection and maintain conditions, in a manner acceptable to installer, that ensure gypsum board assemblies are without damage or deterioration at the time of Substantial Completion.

**END OF SECTION**

## **SECTION 09900**

### **PAINTING**

#### **PART 1 - GENERAL**

##### **1.1 SCOPE:**

- A. The scope of painting work in this project shall be as shown on drawings and specified herein. It shall include all labor, materials, and equipment necessary for a complete
- B. finished installation.

If the schedule herein requires two or more types of painting on the same substrate, the type will be distinguished by the term "paint" meaning an opaque finish (flat, satin, semi-gloss, gloss sheens) and "transparent" meaning a non-opaque, transparent finish (varnishes, stains).

##### **1.2 RELATED SECTIONS:**

- A. Section 07920 – Joint Sealants
- B. Section 06100 = Wood Trim
- C. Section 09250 – Gypsum Board

##### **1.3 DEFINITIONS:**

- A. "Paint" as used herein means all coating systems materials, including primers, emulsions, enamels, coatings, stains, sealers and fillers.
- B. "Exposed surfaces" include portions of the completed construction which are visible when permanent and built-in fixtures and equipment are in place.
- C. "Exterior" includes portions of the completed construction which are subject to outdoor ambient temperature and humidity conditions, including covered but unenclosed areas.
- D. Surfaces to be Painted: Complete coverage of all exposed surfaces is intended, unless indicated "no paint" on drawings. Without restricting the extent of the work to be performed, the work shall include, but is not limited to, the following:
  - 1. Wood: Painting of all exposed woodwork and finish carpentry, interior and exterior, doors and of all architectural woodwork and finish carpentry, except that specified to be pre- finished.
  - 2. Structural Steel: Touch-up after erection (concealed work only), and complete painting for all exposed work.
  - 3. Ferrous Metal: All exposed surfaces of all ferrous metal work, including galvanized, both exterior and interior of building which is not finished painted under other sections, to include steel frames, steel doors, access panels, guards, lintels, gutters, gravel guards, metal flashings, railings (unless otherwise indicated), roof accessories, steel supports, sprinkler riser, roof hatch and grates, bollards, etc.
  - 4. Gypsum Drywall: All exposed surfaces.
  - 5. All Previously Painted Surfaces.



E. Surfaces Not to be Painted: The following areas or items will not require painting under this Section, unless otherwise noted:

1. Concealed duct shafts, concealed spaces, concealed pipes and ducts.
2. Acoustical tile and suspension system.
3. Pre-finished panels.
4. Structural steel work concealed by interior building finish.
5. Gypsum drywall surfaces to receive other finish materials.

#### **1.4 QUALITY ASSURANCE:**

- A. Single Source Responsibility: Provide primers and other undercoat paint produced by same manufacturer as finish coats. Use only thinners approved by paint manufacturer, and use only within recommended limits.
- B. Compatibility: Review other Sections of these specifications in which prime paints are to be provided to ensure compatibility of total coatings system for various substrates. Upon request from other trades, furnish information on finish materials to be used, to enable use of compatible prime coats. Notify the Architect of anticipated problems using the specified materials.
- C. Industry Standards: Comply with the recommendations of the Painting and Decorating Contractors of America, as contained in "PDCA Architectural Specification Manual", except where conflicting and more stringent requirements are specified in this Section.
- D. Applicator Qualifications: Engage an experienced applicator who has completed painting system applications similar in material and extent to those indicated for the Project that have resulted in a construction record of successful in-service performance.
- E. Cooperation with Other Trades: This work shall be scheduled and coordinated with other trades and shall not proceed until other work and/ or project conditions are as required to achieve satisfactory results. General Contractor shall examine the Specifications for the various other trades and materials and shall thoroughly familiarize himself with all their provisions regarding painting.

#### **1.5 SUBMITTALS:**

- A. Product Data: Submit manufacturer's technical information including paint label analysis with handling, storage and application instructions for each material proposed for use. Identify purpose (primer, intermediate or finish coat) and substrate for each paint material.
- B. Samples: Prior to beginning work submit samples for review of color and texture only. Provide a listing of material for each coat of each finish sample.
  1. On 12" x 12" gypsum board and CMU, provide one sample of each color and material. Resubmit samples as requested by Architect until acceptable sheen, color, and texture is achieved.
  2. On 12" x 12" section of plaster, provide one sample of each color and material. Resubmit samples as requested by Architect until acceptable sheen, color, and texture is achieved.

- C. Provide one sample of natural and stained wood finish. Use wood samples approved for Sections 06100, 06200, and 08210 (where applicable). Label and identify each as to location and application.
- D. On completed wall surfaces and other building components, where directed by the Architect, duplicate painted finishes of approved samples. Provide full-coat finish samples on at least 100 sq. ft. of surface, until required sheen, color and texture is obtained; simulate finished lighting conditions for review of in-place work.
  - 1. Final acceptance of colors will be from samples applied on the job.
  - 2. Approved on-site samples will be the standard for acceptance of the permanent work, which shall match approved samples in color, sheen, texture, hiding powers, application workmanship, and other appearance characteristics. Identify, preserve and protect on-site samples.

#### 1.6 **DELIVERY, STORAGE, AND HANDLING:**

- A. Store products in manufacturer's unopened packaging until ready for installation.
- B. Store and dispose of solvent based materials, and materials used with solvent based materials, in accordance with requirements of local authorities having jurisdiction.
- C. Storage of Materials:
  - 1. Store all materials in a single place designated by the General Contractor. The storage place shall be kept neat and clean and all damage shall be made good. Remove soiled or used rags, waste and trash from the building every night and take every precaution to avoid the danger of fire.
  - 2. Emulsion paints shall be protected from exposure to cold weather by storing in shelters so as to prevent freezing of the paint.
- D. Disposal:
  - 1. Never pour leftover coatings down any sink or drain. Use up material on the job or seal can and store safely for future use.
  - 2. Do not incinerate closed containers.
  - 3. For specific disposal contact the local waste management agency.

#### 1.7 **ENVIRONMENTAL CONDITIONS:**

- A. Maintain environmental conditions (temperature, humidity, and ventilation) within limitations recommended by manufacturer for optimum results.
- B. Maintain temperature in building at a constant 65 °F or above during drying of plaster and masonry and provide adequate ventilation for escape of moisture from building in order to prevent mildew, damage to other work and improper drying of paint. Once painting has commenced, provide a constant temperature of 65 °F or above and prevent wide variations in temperature which might result in condensation on freshly painted surfaces.
- C. Exterior painting shall not be performed when the temperature is below 50 °F, while the surface is damp, during cold, rain or frosty weather, or when temperature is likely to drop to freezing within 24 hours. Avoid painting surfaces while they are exposed to hot sun.

- D. Cleaning Area: Before painting is started in any area, it shall be broom-cleaned and dust shall be removed from all areas to be painted. After painting operations begin in a given area, broom cleaning will not be allowed. Cleaning shall then be done only with commercial vacuum cleaning equipment.

**1.8 PROTECTION:**

- A. Drop Cloths: Protect adjacent areas and installation by the use of drop cloths or other approved precautionary measures.
- B. Hardware and Fixtures: Remove and protect hardware, accessories, device plates, lighting fixtures, factory finished work and similar items or provide ample in-place protection. Upon completion of each space, carefully replace all removed items. This work shall be done only by skilled mechanics, using adequate tools commensurate with the work to be done.



## **1.9 WARRANTY:**

- A. Inspection of all surfaces to be coated must be done by the manufacturer's representative to insure proper preparation prior to application (General Contractor to coordinate). All thinners, fillers, primers, and finish coatings shall be from the same manufacturer to support a product warranty. Products other than those submitted shall be accompanied by a letter stating its fitness for use and compatibility.
- B. At project closeout, provide to the Owner executed copies of the Manufacturer's standard form outlining the terms and conditions of any exclusions to their Limited Warranty against Manufacturing Defect.

## **1.10 EXTRA MATERIALS:**

- A. Deliver extra materials to Owner. Furnish extra materials that match products installed as described below, packaged with protective covering for storage and identified with labels clearly describing contents.
- B. Paint, Primers, Accessories, Etc.: Provide minimum of 1 gallon of each paint type and color used for touch-up purposes. Cans shall be clearly marked with color name, number, and type of paint.
- C. At project closeout, provide the color mixture name and code to the Owner for accurate future color matching.

## **PART 2 - PRODUCTS**

### **2.1 MANUFACTURERS:**

- A. Basis Of Design: For purposes of designating type and quality for the work under this Section, drawings and specifications are based on products manufactured or furnished by Benjamin Moore & Company (BMC), except as noted specifically otherwise.
- B. Acceptable Manufacturers: The following manufacturers may have products meeting the herein specified quality that will be acceptable as approved, upon specific product review by the Architect:
  - 1. PPG Industries, Pittsburgh Paints
  - 2. Sherwin Williams
  - 3. Prior Approved Equal

### **2.2 PAINT MATERIALS:**

- A. Except where specifically noted in this section, all paint shall arrive on job ready mixed and pre-tinted. Agitate all paint prior to and during application to ensure uniform color, gloss, and consistency.
- B. Thinner addition shall not exceed manufacturer's printed recommendations. Do not use kerosene or other organic solvents to thin water-based paints.
- C. Where paint is to be sprayed, thin according to manufacturer's current written guidelines.
- D. Compatibility: Provide materials that are compatible with one another and the substrates indicated under conditions of service and application, as demonstrated by manufacturer based on testing and field experience.

**2.3 APPLICATION EQUIPMENT:**

- A. Equipment shall be adequate and commensurate for the work and workmanship required herein.

## 2.4 **ACCESSORY MATERIALS:**

- A. This shall include all required ladders, scaffolding, drop cloths, masking, scrapers, tools, sandpaper, dusters, cleaning solvents and other items required to perform the work and achieve the results herein specified.

## **PART 3 - EXECUTION**

### 3.1 **EXAMINATION:**

- A. The General Contractor and Installer shall review the product manufacturer's special instructions for surface preparation, application, temperature, re-coat times, and product limitations.
- B. The General Contractor and Installer shall review product health and safety precautions listed by the manufacturer.
- C. The General Contractor and Installer shall be responsible for enforcing on site health and safety requirements associated with the Work.
- D. Do not begin installation until substrates have been properly prepared.
- E. Ensure that surfaces to receive paint are dry immediately prior to application.
- F. Ensure that moisture retaining substrates to receive paint have moisture content within tolerances allowed by coating manufacturer. Where exceeding the following values, promptly notify Architect and obtain direction before beginning work.
  - 1. Concrete and Masonry: 3-5 percent. Allow new concrete to cure a minimum of 28 days.
  - 2. Exterior Wood: 17 percent.
  - 3. Interior Wood: 15 percent.
  - 4. Interior Finish Detail Woodwork, Including Trim, and Casework: 10 percent.
  - 5. Plaster and Gypsum: 15 percent.
  - 6. Concrete Slab-On-Grade: Perform calcium chloride test over 24 hour period or other acceptable test to manufacturer. Verify acceptable moisture transmission and pH levels.
- G. Examine surfaces to receive coatings for surface imperfections and contaminants that could impair performance or appearance of coatings, including but not limited to, loose primer, rust, scale, oil, grease, mildew, algae, or fungus, stains or marks, cracks, indentations, or abrasions.
- H. Correct conditions that could impair performance or appearance of coatings in accordance with specified surface preparation procedures before proceeding with coating application.

### 3.2 **PREPARATION – GENERAL:**

- A. Clean surfaces thoroughly prior to coating application.
- B. Do not start work until surfaces to be finished are in proper condition to produce finished surfaces of uniform, satisfactory appearance.
- C. Stains and Marks: Remove completely, if possible, using materials and methods recommended by coating manufacturer; cover stains and marks which cannot be

completely removed with isolating primer or sealer recommended by coating manufacturer to prevent bleed-through.

- D. Remove Mildew, Algae, and Fungus using materials and methods recommended by coating manufacturer.
- E. Remove dust and loose particulate matter from surfaces to receive coatings immediately prior to coating application.
- F. Remove or protect adjacent hardware, electrical equipment plates, mechanical grilles and louvers, lighting fixture trim, and other items not indicated to receive coatings.
- G. Move or protect equipment and fixtures adjacent to surfaces indicated to receive coatings to allow application of coatings.
- H. Protect adjacent surfaces not indicated to receive coatings.
- I. Prepare surfaces in accordance with manufacturer's instructions for specified coatings and indicated materials, using only methods and materials recommended by coating manufacturer.

### 3.3 SURFACE PREPARATION:

- A. Existing Coatings:
  - 1. Remove surface irregularities by scraping or sanding to produce uniform substrate for coating application.
  - 2. Maintenance painting will frequently not permit or require complete removal of all old coatings prior to repainting. However, all surface contamination such as oil, grease, loose paint, mill scale, dirt, foreign matter, rust, mold, mildew, mortar, efflorescence, and sealers must be removed to assure sound bonding to the tightly adhering old paint. Surfaces of old paint films must be clean and dull before repainting (dull surface by sanding). After preparation, coat entire surface with primer (including well adhered previous coatings). **Check for compatibility by applying a test patch of the recommended coating system, covering at least 2 to 3 square feet. Allow to dry one week before testing adhesion per ASTM D3359. If the coating system is incompatible, complete removal is required. Provide test results for Architect's review showing compliance prior to ordering materials.**
- B. Gypsum Board: Repair cracks, holes and other surface defects with joint compound to produce surface flush with adjacent surfaces.
- C. Metals - Aluminum, Mill-Finish: Clean and etch surfaces with a phosphoric acid-water solution or water based industrial cleaner. Flush with clean water and allow to dry, before applying primer coat.
- D. Metals - Ferrous, Unprimed: Remove rust or scale, if present, by wire brush cleaning, power tool cleaning, or sandblast cleaning; remove grease, oil, and other contaminants which could impair coating performance or appearance by solvent cleaning, with phosphoric-acid solution cleaning of welds, bolts and nuts; spot-prime repaired welds with specified primer.
- E. Metals - Ferrous, Shop-Primed: Remove loose primer and rust, if present, by scraping and sanding, feathering edges of cleaned areas to produce uniform flat surface; solvent-clean surfaces and spot-prime bare metal with specified primer, feathering edges to produce uniform flat surface.

- F. Plaster: Repair cracks, holes and other surface defects as required to maintain proper surface

adhesion. Apply patching plaster or Joint compound and sand to produce surface flush with adjacent undamaged surface. Allow a full cure prior to coating application as recommended by the patching compound manufacturer's recommendations.

- G. Wood:

1. Seal knots, pitch streaks, and sap areas with sealer recommended by coating manufacturer; fill nail recesses and cracks with filler recommended by coating manufacturer; sand surfaces smooth.
2. Remove mill marks and ink stamped grade marks.
3. Apply primer coat to back of wood trim and paneling.

### 3.4 **MIXING:**

- A. Quality: At time of application, paint shall show no signs of hard settling, excessive skinning, livering or other deterioration.
- B. Consistency: Paint shall be thoroughly stirred, strained and kept at a uniform consistency during application.
- C. Prohibited Mixing: Paint of different manufacturers shall not be mixed together.
- D. Thinning: Where necessary to suit conditions of surface, temperature, weather and method of application, packaged paint may be thinned immediately prior to application in accordance with the manufacturer's directions. The use of thinner for any reasons shall not relieve the Installer from obtaining complete hiding coverage.
- E. Colorant: Primer may be tinted with a colorant recommended by the manufacturer.

### 3.5 **APPLICATION – GENERAL:**

- A. Application of primers, paints, stains or coatings, by the Installer, will serve as acceptance that surfaces were properly prepared in accordance with the manufacturer's recommendation.
- B. Method of Application: Paint shall be applied in accordance with manufacturer's recommendations. On masonry surfaces, filler coat and other first coats shall be applied by brush. Subsequent coats shall be applied by brush (or roller, on smooth faced units). On all other surfaces, prime and finish coats may be applied by brush or roller.
- C. General Requirements for Workmanship:
  1. Coverage and hide shall be complete. When color, stain, dirt or undercoats show through final coat of paint, the surface shall be covered by additional coats until the paint film is of uniform finish, color, appearance, thickness and coverage, at no additional cost to the Owner.
  2. Rate of application shall not exceed average rate of coverage recommended by manufacturer for the type of surface involved less ten percent (10%) allowance for losses, unless manufacturer's printed recommended specifications state that the recommended rate included normal expected losses.
  3. Minimum dry film thickness per coat shall not be less than thickness recommended by the manufacturer, and in NO case less than as specified herein.
  4. The finished surfaces shall be free from runs, drops, ridges, waves, laps, brush marks

and free of variations in color, texture and finish.

5. All interior wood trim shall be back-primed before installation with enamel undercoat or penetrating sealer, as required.
  6. Sand enamel or varnish finish applied to wood or metal with fine sandpaper and then clean between coats to produce an even, smooth finish.
  7. Remove electrical panel box covers and doors before painting wall. Paint separately and reinstall after all paint is dry.
- D. Apply each coat to uniform coating thickness in accordance with manufacturer's instructions, not exceeding manufacturer's specified maximum spread rate for indicated surface; thins, brush marks, roller marks, orange-peel, or other application imperfections are not permitted.
  - E. Allow manufacturer's specified drying time, and ensure correct coating adhesion, for each coat before applying next coat.
  - F. Sequence of Coats: Sufficient time shall elapse between successive coats to permit proper drying. This period shall be modified as necessary to suit adverse weather conditions.
  - G. Inspect each coat before applying next coat; touch-up surface imperfections with coating material, feathering, and sanding if required; touch-up areas to achieve flat, uniform surface without surface defects visible from 5 feet.
  - H. Remove dust and other foreign materials from substrate immediately prior to applying each coat.
  - I. Where paint application abuts other materials or other coating color, terminate coating with a clean sharp termination line without coating overlap.
  - J. Where color changes occur between adjoining spaces, through framed openings that are of same color as adjoining surfaces, change color at outside stop corner nearest to face of closed door.
  - K. Re-prepare and re-coat unsatisfactory finishes; refinish entire area to corners or other natural terminations.

### 3.6 **CLEANING:**

- A. Clean excess coating materials, and coating materials deposited on surfaces not indicated to receive coatings, as construction activities of this section progress; do not allow to dry.
- B. Re-install hardware, electrical equipment plates, mechanical grilles and louvers, lighting fixture trim, and other items that have been removed to protect from contact with coatings.
- C. Reconnect equipment adjacent to surfaces indicated to receive coatings.
- D. Relocate to original position equipment and fixtures that have been moved to allow application of coatings.
- E. Remove protective materials.

### 3.7 **PROTECTION AND REPAIR:**

- A. Protect completed coating applications from damage by subsequent construction activities.
- B. Repair to Architect's acceptance coatings damaged by subsequent construction

activities. Where repairs cannot be made to Architect's acceptance, re-apply finish coating to nearest adjacent change of surface plane, in both horizontal and vertical directions.

- C. A minimal amount of touch-up work to newly painted surfaces will be allowed (one touch-up per every 10 square feet of wall area), but only if the repair is not visible upon close inspection. Contractor must refinish a whole wall rather than spot-finish where there are numerous repairs to be made, or where remedial work is unsatisfactory.

**3.8 PAINTING SCHEDULE - EXPLANATION:**

- A. Except as specified under the "Surfaces Not to be Painted" paragraph, the surfaces listed in the painting schedule shall receive the surface treatment, paints and number of coats indicated. Piping and ductwork shall not be painted until the piping and ductwork have been tested and approved.

**3.9 PAINTING SCHEDULE:**

A. Interior Gypsum Board (Walls):

- 1. First Coat: Regal Select Waterborne Interior Paint Pearl Finish 550 Series, Pearl Sheen at 1.5 mils dry per coat.
- 2. Second and Third Coats: Regal Select Waterborne Interior Paint Pearl Finish 550 Series, Pearl Sheen at 1.5 mils dry per coat.

B. Interior Wood (Painted):

- 1. First Coat: Advance waterborne Interior Alkyd Primer 790 Series, Flat Sheen at 1.5 mils dry per coat.
- 2. Second and Third Coats: Advance Waterborne Interior Alkyd Satin 792 Series, Satin Sheen at 1.35 mils dry per coat.

**END OF  
SECTION**

**SECTION 09 91 13 – EXTERIOR PAINTING**

**PART 1 - GENERAL**

**1.1 RELATED DOCUMENTS**

- A. Drawings and general provisions of the Contract, including General and Supplementary Conditions and Division 01 Specification Sections, apply to this Section.

**1.2 SUMMARY**

- A. This section includes the following:

- 1. This section includes the following:

- a) Surface preparation and the application of paint systems on the following exterior substrates:

- 1) Ferrous metal
- 2) Wood

- B. Finish painted exterior surfaces as indicate in schedule at the end of this section.

**1.3 REFERENCES**

- A. ASTM 16D - Definition of Terms Relating to Paint, Varnish, Lacquer, and Related Products.

**1.4 DEFINITIONS**

- A. Conform to ASTM 16D - Definition of terms relating to Paint, Varnish, Lacquer and Related Products.

**1.5 SUBMITTALS**

- A. Submit product data on all finish products under provisions of Section 01 33 00.
- B. Submit manufacturer's application instructions under provisions of Section 01 33 00.
- C. Samples for verification:
  - 1. Submit samples on rigid backing 8" square.
  - 2. Step coats on samples to show each coat required for system.
  - 3. Label each coat on sample
  - 4. Label each sample for location and application area.



**1.6 DELIVERY, STORAGE, AND HANDLING**

- A. Deliver paint materials under provisions of Section 016600 in sealed original labeled containers, bearing manufacturer's name, type of paint, brand name, color designation, and instructions for mixing and/or reducing.
- B. Provide adequate storage facilities. Store paint materials at minimum ambient temperature of 50 degrees F and maximum of 95 degrees F in well ventilated area.
- C. Take precautionary measures to prevent fire hazards and spontaneous combustions.

**1.7 ENVIRONMENTAL REQUIREMENTS**

- A. Measure moisture content of surfaces using an electronic moisture meter. Do not apply finishes unless moisture contents of surfaces are below the following maximums:
  - 1. Wood: 10 percent.
- B. Ensure surface temperatures or the surrounding air temperature is above 40 degrees F before applying finishes. Minimum application temperatures for latex paints for interior work is between 50 degrees F and 95 degrees F for exterior work. Minimum application temperature for varnish and stain finishes is 65 degrees F.
- C. Provide adequate continuous ventilation and sufficient heating facilities to maintain temperatures above 50 degrees F for 24 hours before, during and 48 hours after application of finishes.
- D. Provide minimum 25 foot candles of lighting on surfaces to be finished.
- E. **THE USE OF SPRAY PAINTING EQUIPMENT AND PAINT ROLLERS FOR THE EXTERIOR WOOD SLEEPERS AND FERROUS METALS SHALL NOT BE PERMITTED. ALL PAINTING SHALL BE DONE BY THE USE OF BRUSHES EXCEPT AS NOTED. CIGAR ROLLERS ARE PERMITTED TO BE USED AT FERROUS METALS.**

**1.8 EXTRA MATERIALS**

- A. Provide not less than five (5) gallons of each color and material used.
- B. Containers shall be tightly sealed and clearly labeled for identification.

**1.9 SURFACES TO BE PAINTED**

- A. Ferrous Metals: All surfaces exposed to view and to the weather.
- B. New wood sleepers: All surfaces exposed to view and to the weather.

**1.10 SURFACES NOT TO BE PAINTED**

- A. Plastic Fabrications (balcony floor boards).

**PART 2 - PRODUCTS**

**2.1 PAINT, GENERAL**

- A. Painting Schedule: refer to end of Part 3 of this Section for listing of applications for each product.
- B. Products, General: Refer to Part 2 for specific products. Subject to compliance with requirements, provide the products indicated or comparable products from one of the listed manufacturers for each substrate.
- C. Colors: As selected by Architect from manufacturer's full range.
- D. Material Compatibility:
  - 1. Provide materials for use within each paint system that are compatible with one another and substrates indicated, under conditions of service and application as demonstrated by manufacturer, based on testing and field experience.
  - 2. For each coat in a paint system, provide products recommended in writing by manufacturers of topcoat for use in paint system and on substrate indicated.

**2.2 MANUFACTURERS - PRIMER (EXTERIOR)**

- A. Subject to compliance with requirements, provide products produced by one of the following manufacturers:
  - 1. Ferrous Metal:
    - a) Sherwin Williams Co. – Kem Kromik® Universal Metal Primer, B50NZ6 Series.
    - b) Devguard-4360 Int-Ext Industrial Primer.
- B. Subject to compliance with requirements, provide products produced by one of the following manufacturers:

**HOUSING AUTHORITY OF NEW ORLEANS  
BALCONY ALTERATIONS AT THE  
GUSTE III HOUSING COMMUNITY, BUILDING M**

**December 12, 2022  
Architect's Proj. #22-013**

1. Wood:
  - a) Sherwin-Williams Co. - A-100® Exterior Oil Stain Blocking.
  - b) PPG-Seal Grip Interior Exterior Alkyd Primer 17-941 NF.

**2.3 MANUFACTURERS - PAINT (EXTERIOR)**

A. Subject to compliance with requirements, provide products produced by one of the following manufacturers:

1. Ferrous Metal:
  - a) Sherwin-Williams Co. - Industrial Urethane Alkyd Enamel B54 – 150 Series.
  - b) Devguard – 4308 Industrial Alkyd.

B. Subject to compliance with requirements, provide products produced by one of the following manufacturers:

1. Wood:
  - a) Sherwin-Williams Co. – Super Paint® Exterior Gloss Latex A84 Series.
  - b) PPG-Perma Crete 90-1310 Gloss.

**2.4 MATERIALS**

- A. Coatings: Ready mixed, except field catalyzed coatings. Process pigments to a soft paste consistency, capable of being readily and uniformly dispersed to a homogeneous coating.
- B. Coatings: Good flow and brushing properties; capable of drying or curing free of streaks or sags.
- C. Accessory Materials: Linseed oil, shellac, turpentine, paint thinners and other materials not specifically indicated but required to achieve the finishes specified, of commercial quality.

**PART 3 - EXECUTION**

**3.1 EXAMINATION**

- A. Thoroughly examine surfaces scheduled to be painted prior to commencement of work. Report in writing to the Architect, any condition that may potentially affect proper application. Do not commence until such defects have been corrected.

- B. Correct defects and deficiencies in surfaces which may adversely affect work of this Section.

### 3.2 PROTECTION

- A. Adequately protect other surfaces from paint and damage. Repair damage as a result of inadequate or unsuitable protection.
- B. Furnish sufficient drop cloths, shields, and protective equipment to prevent paint droppings from fouling surfaces not being painted and in particular, surfaces which storage and preparation area.
- C. Place cotton waste, cloths, and material which may constitute a fire hazard in closed metal containers and remove daily from site.

### 3.3 PREPARATION

- A. Comply with manufacturers written instructions and recommendations in "MPI Architectural Painting Specification Manual" applicable to substrates indicated.
- B. Comply with manufacturer's written instructions and recommendations in "MPI Architectural Painting Specification Manual" applicable to substrates and paint systems indicated.
- C. Remove existing sealant where wood or metal surfaces meet masonry surfaces prior to scraping and sanding items to be painted.
- D. Clean substrates of substances that could impair bond of paints, including dirt, oil, grease, and incompatible paints and encapsulates.
- E. Apply paints to produce surface films without cloudiness, spotting, holidays, laps, brush marks, roller tracking, runs sags, ropiness, or other surface imperfections. Cut in sharp lines and color breaks.
- F. Protect work of other trades against damage from paint application. Correct damage to work of other trades by cleaning, repairing, replacing, and refinishing, as approved by Architect, and leave in an undamaged condition.
- G. At completion of construction activities of other trades, touch up and restore damaged or defaced painted surfaces.
- H. Fill holes, checks, and other imperfections in wood surfaces with resin bonding agent and exterior epoxy filler in accordance with the filler manufacturer's instructions. Smooth off and sand smooth to match adjacent surfaces.

- I. Remove grease, rust, scale, dirt, and dust from steel and iron surfaces. Where heavy coatings of scale are evident, removed by wire brushing, grinding, or any other necessary method. Ensure steel surfaces are satisfactory before paint finishing.
- J. Clean unprimed steel surfaces by washing with solvent. Apply a treatment of phosphoric acid solution, ensuring weld joints, bolts and nuts are similarly cleaned. Prime surfaces to indicate defects, if any. Paint after defects have been remedied.
- K. Sand and scrape existing steel surfaces to remove all existing paint and rust. Clean surfaces with solvent. Prime bare steel surfaces.

### **3.4 APPLICATIONS**

- A. Apply each coat at proper consistency.
- B. Each coat of paint is to be slightly darker than preceding coat unless otherwise approved by the Architect.
- C. Sand lightly between coats to achieve required finish.
- D. Do not apply finishes on surfaces that are not sufficiently dry.
- E. Allow each coat of finish to dry before following coat is applied, unless directed otherwise by manufacturer.

### **3.5 CLEANING**

- A. As work proceeds and upon completion, promptly remove paint where spilled, splashed, or spattered.
- B. During progress of work, keep premises free from any unnecessary accumulation of tools, equipment, surplus materials, and debris.
- C. Upon completion of work, leave premises neat and clean, to the satisfaction of Architect.

### **3.6 PAINTING AND FINISHING SCHEDULE (EXTERIOR)**

- A. Ferrous Metal:
  - 1. Paint Finish - 1 coat alkyd primer.
  - 2. Paint Finish - 2 coats alkyd gloss finish.
- B. Wood:

**HOUSING AUTHORITY OF NEW ORLEANS  
BALCONY ALTERATIONS AT THE  
GUSTE III HOUSING COMMUNITY, BUILDING M**

**December 12, 2022  
Architect's Proj. #22-013**

1. Paint Finish - 1 coat alkyd exterior primer.
2. Paint Finish - 2 coats acrylic latex gloss finish.

**END OF SECTION 09 91 13**

# ATTACHMENT “A”

## **SUPPLEMENTAL INFORMATION**

GUSTE III RETROFIT PLAN  
(Case 2:22-CV-03568-LMA-DPC)

## Appendix G

### GUSTE III RETROFIT PLAN

Guste III Apartments  
2100 Clio Street  
New Orleans, LA 70113



#### Global Notes and Requirements:

1. Safe Harbor used for evaluation and preparation of the retrofit list: the FH Act, the FH HUD Regulations, the FHAA Guidelines, and ANSI A.117.1 1986.
2. Safe Harbor to be used for retrofits: ADA 2010 Standards (at public areas only); IBC 2015 and ICC/A117.1 2009.
3. Provide chart or list of covered dwelling units by unit number, block number, and address. This will assist with tracking retrofit completion and confirm the unit counts. Chart must be submitted to DOJ before retrofit work begins.



**A. Routes and Entrances to Covered Dwelling Units and Common Areas**

1. Provide a route from each covered dwelling unit to site arrival points including the public right-of-way sidewalk. These paths must be as direct as possible. Preferred routes are indicated in green, alternate routes may be implemented only if preferred route is not feasible. Changes from preferred routes to alternate routes must be submitted to DOJ for review and approval prior to starting retrofits.
2. Provide a route from each covered dwelling unit to all common areas serving that unit. These include trash, parking, mail, a route to the main building at South Liberty Street and Clio Street, and a route to the playground on Rev. John Raphael Jr. Way.
3. Be designed in such a way as to allow the resident to use their trash bin on a regular basis and pull their trash bin out to the designated for service using as short a route as possible. Trash pads will be on the courtyard side of each building, located on an accessible route, and in a location where the cans will not obstruct the sidewalks and access aisles.
4. Routes to existing parking spaces are included at all buildings except for Building B. At Building B, relocate parking as diagrammed.

Building Addresses:

- Building A (1202 and 1204 Freret Street)
- Building B (1215 and 1217 Rev. John Raphael Jr. Way)
- Building C (1210 and 1212 Rev. John Raphael Jr. Way Street)
- Building D (1222 and 1224 Rev. John Raphael Jr. Way)
- Building E (1215 and 1217 Liberty Street)
- Building F (2310 and 2312 Erato Street)
- Building G (2222 and 2224 Erato Street)

Routes not surveyed by DOJ team should be included in a future report addressing unsurveyed routes.

Routes not yet surveyed:

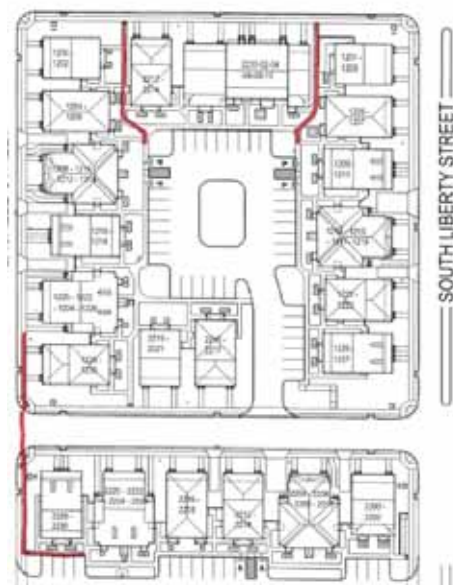

**Accessible Route Diagram:**

- Buildings: orange highlighter
- Accessible Route: green highlighter
- Alternate Route: blue highlighter



	<b>Lack of Accessible Route</b>	
1	 <p><i>View of trash cans and wall/fence between the trash cans and the accessible unit entry.</i></p>  <p><i>View of route to trash and of unit entry on the other side of wall and fence.</i></p>  <p><i>View of back sidewalk and trash cans at 2412 Erato.</i></p>	<p>Primary entry doors are not accessible at Building Types G and H. All primary entry units have changes in level (changes in level such as steps are not allowed).</p> <p>There is no direct accessible route between dwelling units and trash areas. Trash is picked up on a house-by-house basis and the cans are placed in an area between buildings accessible from the front only.</p> <p>At least one accessible route connecting accessible buildings, accessible facilities, accessible elements and accessible spaces on the same site is required. (Guidelines Requirement 2).</p> <p>Changes in level greater than 1/2 inch (stairs) are not allowed at an accessible route. (Guidelines Requirement 1(5), Guidelines Requirement 2, ANSI 1986 4.3.8; ANSI 1986 4.5.2).</p> <p>All premises with covered dwelling units must contain an accessible route into and through all portions of the unit. (Guidelines Requirement 4).</p> <p><i>Retrofit:</i>  <i>Provide continuous accessible routes as diagrammed above. Retrofits include work to address gaps, level changes, excessive slopes and other issues as listed below and as required to complete the routes described. Trash pick-up will be provided at the courtyard side of the residences and retrofit includes installation of new pads for the cans at each building.</i></p>



*View of typical front entry at Building Types G and H, 1222 Rev. John Raphael Jr. Way*

2

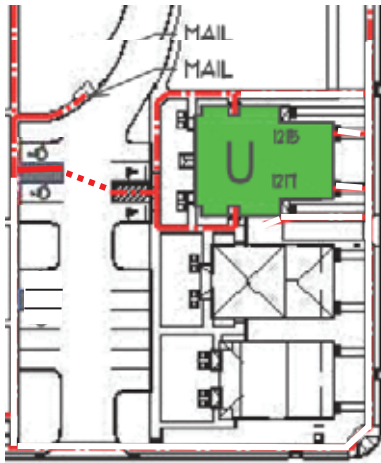

*Correct H/C parking location & new accessible route to mail*



*Path for accessible parking behind 1215-1217 RJR Way*

The route to the mailboxes from 1215-17 Rev. John Raphael Jr. Way has inaccessible features (see diagram and items below) and requires significant detours from the path used by other residents. There is no direct accessible route between dwelling units and the mail boxes. Access to mail is not equivalent to the access provide to non-disabled residents.

Common use areas must be readily accessible to and usable by people with disabilities. Surfaces must meet the requirements of ANSI 1986 4.3. (Guidelines Requirement 2; ANSI 1986 4.3; ANSI 1986 4.5.1).



Exterior routes must be pedestrian routes that are separate from the road or driveway.

*Retrofit:*



*Relocate 2 designated accessible parking spaces as indicated on the diagram (spaces may shift one space to the north or south as is necessary to adjust for existing slopes). Restripe the 2 existing spaces to be 3 standard parking. Confirm that the surfaces of the new designated accessible spaces and access aisle slope less than 2% in running and cross slope directions. Restripe, apply ISA to the spaces and post signage at the head of each space as required by the safe harbor and local authorities. Construct a new parallel curb ramp at the head of the access aisle. New curb ramp and landing at access aisle to comply with safe harbor. Cross slopes not to exceed 2%; running slopes at ramp sections not to exceed 8.3%.*





<p>3</p>	 <p><i>Landing at mailboxes.</i></p>  <p><i>Width of landing.</i></p>	<p>The route to the mailboxes serving 1202-04 Freret St. and 1215-17 Rev. John Raphael Jr. Way is a dead end walk and does not have space to turn around at the boxes. The landing is 48 inches wide (minimum 60 inches required).</p> <p>Common use areas must be readily accessible to and usable by people with disabilities. Surfaces must meet the requirements of ANSI 1986 4.3. (Guidelines Requirement 2; ANSI 1986 4.3; ANSI 1986 4.5.1).</p> <p><i>Retrofit:</i>  <i>Install sufficient concrete alongside existing concrete in front of the mailboxes to create space (60" diameter) for a wheelchair to turnaround.</i></p>																																				
<p>4</p>	 <p><i>Typical building entry, 1215 S. Liberty.</i></p>  <p><i>Step at back entry to 1222 Rev. John Raphael Jr. Way.</i></p>	<p>Routes serving the front doors (primary pedestrian entries) of all 16 four-plex dwelling units (Building Types G and H) do not connect to pedestrian site arrival points or to common use areas. Routes end at steps and curbs (not allowed). One unit has steps to both front and back door (1222 Rev. John Raphael Jr. Way).</p> <table border="1"> <thead> <tr> <th><u>Unit</u></th> <th><u>Photo</u></th> </tr> </thead> <tbody> <tr><td>1202 Freret Street, front door, 4 steps.</td><td></td></tr> <tr><td>1204 Freret Street, front door, 4 steps.</td><td></td></tr> <tr><td>2306 Erato, front door, 5 steps.</td><td></td></tr> <tr><td>2308 Erato, front door, 5 steps.</td><td></td></tr> <tr><td>2322 Erato, front door, 5 steps.</td><td></td></tr> <tr><td>2324 Erato, front door, 5 steps.</td><td></td></tr> <tr><td>2410 Erato, front door, 4 steps.</td><td></td></tr> <tr><td>2412 Erato, front door, 4 steps.</td><td></td></tr> <tr><td>1210 Rev. John Raphael Jr. Way, front door, 5 steps.</td><td></td></tr> <tr><td>1212 Rev. John Raphael Jr. Way, front door, 5 steps.</td><td></td></tr> <tr><td>1215 Rev. John Raphael Jr. Way, front door, 5 steps.</td><td></td></tr> <tr><td>1217 Rev. John Raphael Jr. Way, front door, 5 steps.</td><td></td></tr> <tr><td>1222 Rev. John Raphael Jr. Way, front door, 5 steps.</td><td></td></tr> <tr><td>1222 Rev. John Raphael Jr. Way, back door, 1 step.</td><td></td></tr> <tr><td>1224 Rev. John Raphael Jr. Way, front door, 5 steps.</td><td></td></tr> <tr><td>1215 S. Liberty St., front door, 6 steps.</td><td></td></tr> <tr><td>1217 S. Liberty St., front door, 6 steps.</td><td></td></tr> </tbody> </table> <p>Common use areas must be readily accessible to and usable by people with disabilities. Surfaces must meet</p>	<u>Unit</u>	<u>Photo</u>	1202 Freret Street, front door, 4 steps.		1204 Freret Street, front door, 4 steps.		2306 Erato, front door, 5 steps.		2308 Erato, front door, 5 steps.		2322 Erato, front door, 5 steps.		2324 Erato, front door, 5 steps.		2410 Erato, front door, 4 steps.		2412 Erato, front door, 4 steps.		1210 Rev. John Raphael Jr. Way, front door, 5 steps.		1212 Rev. John Raphael Jr. Way, front door, 5 steps.		1215 Rev. John Raphael Jr. Way, front door, 5 steps.		1217 Rev. John Raphael Jr. Way, front door, 5 steps.		1222 Rev. John Raphael Jr. Way, front door, 5 steps.		1222 Rev. John Raphael Jr. Way, back door, 1 step.		1224 Rev. John Raphael Jr. Way, front door, 5 steps.		1215 S. Liberty St., front door, 6 steps.		1217 S. Liberty St., front door, 6 steps.	
<u>Unit</u>	<u>Photo</u>																																					
1202 Freret Street, front door, 4 steps.																																						
1204 Freret Street, front door, 4 steps.																																						
2306 Erato, front door, 5 steps.																																						
2308 Erato, front door, 5 steps.																																						
2322 Erato, front door, 5 steps.																																						
2324 Erato, front door, 5 steps.																																						
2410 Erato, front door, 4 steps.																																						
2412 Erato, front door, 4 steps.																																						
1210 Rev. John Raphael Jr. Way, front door, 5 steps.																																						
1212 Rev. John Raphael Jr. Way, front door, 5 steps.																																						
1215 Rev. John Raphael Jr. Way, front door, 5 steps.																																						
1217 Rev. John Raphael Jr. Way, front door, 5 steps.																																						
1222 Rev. John Raphael Jr. Way, front door, 5 steps.																																						
1222 Rev. John Raphael Jr. Way, back door, 1 step.																																						
1224 Rev. John Raphael Jr. Way, front door, 5 steps.																																						
1215 S. Liberty St., front door, 6 steps.																																						
1217 S. Liberty St., front door, 6 steps.																																						



		<p>the requirements of ANSI 1986 4.3. (Guidelines Requirement 2; ANSI 1986 4.3; ANSI 1986 4.5.1).</p> <p><i>Retrofit:</i></p> <p><i>Provide accessible routes as diagrammed above.</i></p> <p><i>Include an accessible route to the back door of 1222 Rev. John Raphael Jr. Way.</i></p>																																																				
	<b>Inaccessible Walking Surfaces</b>																																																					
5	 <p><i>Route NW of Bldg. M on Clio.</i></p>  <p><i>Cross slope.</i></p>	<p>Cross slopes at required accessible routes are greater than 2.0% (maximum 2% allowed).</p> <table border="1"> <thead> <tr> <th><u>Location</u></th> <th><u>Cross Slope</u></th> </tr> </thead> <tbody> <tr><td>a) NW of Bldg. M on Clio</td><td>4.6%</td></tr> <tr><td>b) NW of Bldg. M on Clio</td><td>3.4%</td></tr> <tr><td>c) NW of Bldg. M on Clio</td><td>3.1%</td></tr> <tr><td>d) NW of Bldg. M on Clio</td><td>3.2%</td></tr> <tr><td>e) East of SE curb ramp at Clio and S. Liberty</td><td>3.6%</td></tr> <tr><td>f) West of Bldg. M on S. Liberty</td><td>3.7%</td></tr> <tr><td>g) West of Bldg. M on S. Liberty</td><td>3.1%</td></tr> <tr><td>h) West of Bldg. M on S. Liberty</td><td>3.7%</td></tr> <tr><td>i) West of Bldg. M on S. Liberty</td><td>3.8%</td></tr> <tr><td>j) SW corner of Bldg. M at turn to pedestrian gate</td><td>3.1%</td></tr> <tr><td>k) Not used.</td><td></td></tr> <tr><td>l) South of Bldg. M by parking</td><td>3.2%</td></tr> <tr><td>m) South of Bldg. M east of acc. parking spaces</td><td>3.6%</td></tr> <tr><td>n) SE end of Bldg. M, along pkg.</td><td>3.7%</td></tr> <tr><td>o) SE end of Bldg. M, along pkg.</td><td>3.9%</td></tr> <tr><td>p) SE end of Bldg. M, along pkg.</td><td>3.2%</td></tr> <tr><td>q) West of SW curb ramp at Clio and Simon Bolivar</td><td>4.2%</td></tr> <tr><td>r) West of SW curb ramp at Clio and Simon Bolivar</td><td>3.2%</td></tr> <tr><td>s) At walk bypassing curb ramp at Erato and Rev. John Raphael</td><td>3.4%</td></tr> <tr><td>t) Block 2400, south walk at at turn to 2412 Erato</td><td>3.8%</td></tr> <tr><td>u) Not used.</td><td></td></tr> <tr><td>v) Not used.</td><td></td></tr> <tr><td>w) Not used.</td><td></td></tr> <tr><td>x) Not used.</td><td></td></tr> <tr><td>y) Block 2300, west walk to</td><td>3.7%</td></tr> </tbody> </table>	<u>Location</u>	<u>Cross Slope</u>	a) NW of Bldg. M on Clio	4.6%	b) NW of Bldg. M on Clio	3.4%	c) NW of Bldg. M on Clio	3.1%	d) NW of Bldg. M on Clio	3.2%	e) East of SE curb ramp at Clio and S. Liberty	3.6%	f) West of Bldg. M on S. Liberty	3.7%	g) West of Bldg. M on S. Liberty	3.1%	h) West of Bldg. M on S. Liberty	3.7%	i) West of Bldg. M on S. Liberty	3.8%	j) SW corner of Bldg. M at turn to pedestrian gate	3.1%	k) Not used.		l) South of Bldg. M by parking	3.2%	m) South of Bldg. M east of acc. parking spaces	3.6%	n) SE end of Bldg. M, along pkg.	3.7%	o) SE end of Bldg. M, along pkg.	3.9%	p) SE end of Bldg. M, along pkg.	3.2%	q) West of SW curb ramp at Clio and Simon Bolivar	4.2%	r) West of SW curb ramp at Clio and Simon Bolivar	3.2%	s) At walk bypassing curb ramp at Erato and Rev. John Raphael	3.4%	t) Block 2400, south walk at at turn to 2412 Erato	3.8%	u) Not used.		v) Not used.		w) Not used.		x) Not used.		y) Block 2300, west walk to	3.7%
<u>Location</u>	<u>Cross Slope</u>																																																					
a) NW of Bldg. M on Clio	4.6%																																																					
b) NW of Bldg. M on Clio	3.4%																																																					
c) NW of Bldg. M on Clio	3.1%																																																					
d) NW of Bldg. M on Clio	3.2%																																																					
e) East of SE curb ramp at Clio and S. Liberty	3.6%																																																					
f) West of Bldg. M on S. Liberty	3.7%																																																					
g) West of Bldg. M on S. Liberty	3.1%																																																					
h) West of Bldg. M on S. Liberty	3.7%																																																					
i) West of Bldg. M on S. Liberty	3.8%																																																					
j) SW corner of Bldg. M at turn to pedestrian gate	3.1%																																																					
k) Not used.																																																						
l) South of Bldg. M by parking	3.2%																																																					
m) South of Bldg. M east of acc. parking spaces	3.6%																																																					
n) SE end of Bldg. M, along pkg.	3.7%																																																					
o) SE end of Bldg. M, along pkg.	3.9%																																																					
p) SE end of Bldg. M, along pkg.	3.2%																																																					
q) West of SW curb ramp at Clio and Simon Bolivar	4.2%																																																					
r) West of SW curb ramp at Clio and Simon Bolivar	3.2%																																																					
s) At walk bypassing curb ramp at Erato and Rev. John Raphael	3.4%																																																					
t) Block 2400, south walk at at turn to 2412 Erato	3.8%																																																					
u) Not used.																																																						
v) Not used.																																																						
w) Not used.																																																						
x) Not used.																																																						
y) Block 2300, west walk to	3.7%																																																					



	mail	
	z) Block 2300, mail center	5.9%
	aa) Block 2300, S of 2308 at turn to the east	4.1%
	bb) Block 2300, S of 2306 at turn to the west	3.9%
	cc) West end of north driveway by 1202 – 04 Freret St.	3.8%
	dd) West sidewalk, by 1202-04 Freret St.	4.8%
	ee) Not used.	
	ff) North side of Erato, west of west of driveway between Freret & Rev. John Raphael Jr. Way	4.9%
	gg) Sidewalk crossing driveway North side of Erato, between Freret & Rev. John Raphael Jr. Way	5.1%
	hh) Sidewalk crossing driveway North side of Erato, between Freret & Rev. John Raphael Jr. Way, east end.	3.1%
	ii) North side of Erato, east of driveway between Freret & Rev. John Raphael Jr. Way	3.9%
	jj) Not used.	
	kk) Not used.	
	ll) Not used.	
	mm) Not used.	
	nn) North side of Erato, sidewalk crossing the driveway entry	3.1%
	oo) Walk to back door of 1217 S. Liberty St.	3.7%
	pp) Not used.	
	Additional inaccessible features affecting only UFAS units:	
	qq) Front sidewalk, 2500 block of Erato	3.3%
	rr) Block 2500, NW turn to mail	3.0%
	ss) Block 2500, SW turn to mail	3.2%
	tt) Block 2500, east end walk	3.5%
	uu) Block 2400, west sidewalk at curb ramp to driveway	4.1%



		<p>vv) Block 2400, south walk west of mail center 3.4%</p> <p>A maximum 2% cross slope is allowed at an accessible route. (Guidelines Requirement 1, Guidelines Requirement 2, ANSI 1986 4.3.7).</p> <p><i>Retrofit:</i></p> <p><i>Remove and replace concrete as required to correct cross sloped sections and provide a continuous accessible route as indicated on the Accessible Route Diagram.</i></p>																				
<p>6</p>	 <p><i>Curb ramp at parking by mail, Block 2500 (measuring running slope).</i></p>  <p><i>Cross slope at curb ramp, Block 2500</i></p>	<p>Curb ramp cross slopes are greater than 2.0% (maximum 2.0% allowed).</p> <table border="1"> <thead> <tr> <th><u>Location</u></th> <th><u>Cross Slope</u></th> </tr> </thead> <tbody> <tr> <td>a) Not used.</td> <td></td> </tr> <tr> <td>b) Not used.</td> <td></td> </tr> <tr> <td>c) Not used.</td> <td></td> </tr> <tr> <td>d) Not used.</td> <td></td> </tr> <tr> <td>e) West side of driveway behind 1202 Freret St.</td> <td>5.2%</td> </tr> <tr> <td>f) West side of driveway, north of Erato, east of Freret St.</td> <td>4.6%</td> </tr> <tr> <td>g) West side of driveway, north of Erato, east of Freret St.</td> <td>6.4%</td> </tr> <tr> <td>h) East side of driveway, north of Erato, east of Freret St.</td> <td>6.7%</td> </tr> <tr> <td>i) East side of driveway, north of Erato, east of Freret St.</td> <td>3.6%</td> </tr> </tbody> </table> <p>A maximum 2% cross slope is allowed at an accessible route. (Guidelines Requirement 1, Guidelines Requirement 2, ANSI 1986 4.3.7).</p> <p><i>Retrofit:</i></p> <p><i>Remove and replace curb ramps and adjacent concrete as required to provide a continuous accessible route as indicated on the Accessible Route Diagram.</i></p>	<u>Location</u>	<u>Cross Slope</u>	a) Not used.		b) Not used.		c) Not used.		d) Not used.		e) West side of driveway behind 1202 Freret St.	5.2%	f) West side of driveway, north of Erato, east of Freret St.	4.6%	g) West side of driveway, north of Erato, east of Freret St.	6.4%	h) East side of driveway, north of Erato, east of Freret St.	6.7%	i) East side of driveway, north of Erato, east of Freret St.	3.6%
<u>Location</u>	<u>Cross Slope</u>																					
a) Not used.																						
b) Not used.																						
c) Not used.																						
d) Not used.																						
e) West side of driveway behind 1202 Freret St.	5.2%																					
f) West side of driveway, north of Erato, east of Freret St.	4.6%																					
g) West side of driveway, north of Erato, east of Freret St.	6.4%																					
h) East side of driveway, north of Erato, east of Freret St.	6.7%																					
i) East side of driveway, north of Erato, east of Freret St.	3.6%																					





Changes in Level																								
7	 <p><i>Steps at walk behind Bldg. M, SE corner.</i></p>  <p><i>Steps at west end Block 2500.</i></p>  <p><i>Steps at north end of walk to park south of Clio.</i></p>	<p>There are changes in level (steps) at sidewalks. The vertical changes in level are greater than 1/4 inch and the changes in level are not beveled or ramped (not allowed).</p> <table border="1" data-bbox="701 384 1279 856"> <thead> <tr> <th data-bbox="701 384 1101 415">Location</th> <th data-bbox="1101 384 1279 415">Change</th> </tr> </thead> <tbody> <tr> <td data-bbox="701 422 1101 453">a) Not used.</td> <td data-bbox="1101 422 1279 453"></td> </tr> <tr> <td data-bbox="701 459 1101 491">b) Not used.</td> <td data-bbox="1101 459 1279 491"></td> </tr> <tr> <td data-bbox="701 497 1101 529">c) Not used.</td> <td data-bbox="1101 497 1279 529"></td> </tr> <tr> <td data-bbox="701 535 1101 567">d) Not used.</td> <td data-bbox="1101 535 1279 567"></td> </tr> <tr> <td data-bbox="701 573 1101 604">e) North of 1202 Freret</td> <td data-bbox="1101 573 1279 604">2 steps</td> </tr> <tr> <td data-bbox="701 611 1101 642">f) Not used.</td> <td data-bbox="1101 611 1279 642"></td> </tr> <tr> <td data-bbox="701 648 1101 743">g) West side of Rev. John Raphael Jr. Way, south of 1217</td> <td data-bbox="1101 648 1279 743">1 inch</td> </tr> <tr> <td data-bbox="701 749 1101 781">h) Not used.</td> <td data-bbox="1101 749 1279 781"></td> </tr> <tr> <td data-bbox="701 787 1101 819">i) Not used.</td> <td data-bbox="1101 787 1279 819"></td> </tr> <tr> <td data-bbox="701 825 1101 856">j) Not used.</td> <td data-bbox="1101 825 1279 856"></td> </tr> </tbody> </table> <p>Changes in level greater than 1/2 inch (stairs) are not allowed at an accessible route. (Guidelines Requirement 1(5), Guidelines Requirement 2, ANSI 1986 4.3.8; ANSI 1986 4.5.2).</p> <p><i>Retrofits:</i></p> <p><i>Install ramp or sidewalk free of changes in level connecting the courtyard sidewalk behind 1200-02 Freret and Clio. Existing steps may remain or may be removed.</i></p> <p><i>Replace concrete or grind to 1:12 slope at change in level on west side of Rev. John Raphael Jr. Way between Erato and Clio.</i></p>	Location	Change	a) Not used.		b) Not used.		c) Not used.		d) Not used.		e) North of 1202 Freret	2 steps	f) Not used.		g) West side of Rev. John Raphael Jr. Way, south of 1217	1 inch	h) Not used.		i) Not used.		j) Not used.	
Location	Change																							
a) Not used.																								
b) Not used.																								
c) Not used.																								
d) Not used.																								
e) North of 1202 Freret	2 steps																							
f) Not used.																								
g) West side of Rev. John Raphael Jr. Way, south of 1217	1 inch																							
h) Not used.																								
i) Not used.																								
j) Not used.																								



Inaccessible Ramp Features															
<p>8</p>  <p><i>Top landing at Block 2500 ramp.</i></p>  <p><i>Length of landing at Block 2500.</i></p>	<p>Landings at ramps are not 60 inches long (minimum 60 inches required).</p> <table border="1" data-bbox="703 327 1279 512"> <thead> <tr> <th data-bbox="703 365 821 394">Location</th> <th data-bbox="1101 327 1203 394">Length (inches)</th> </tr> </thead> <tbody> <tr> <td data-bbox="703 401 857 430">a. Not used.</td> <td></td> </tr> <tr> <td data-bbox="703 436 857 466">b. Not used.</td> <td></td> </tr> <tr> <td data-bbox="703 472 992 501">c. Ramp to 2324 Erato</td> <td data-bbox="1252 472 1406 501">48 (approx)</td> </tr> </tbody> </table> <p>Ramp landing length shall be a minimum of 60 inches clear in the direction of travel. (Guidelines Requirement 1, Guidelines Requirement 2, ANSI 1986 4.8.4(2)).</p> <p><i>Retrofit:</i></p> <p><i>Extend the concrete walk to 60" so as to provide a full size landing at the top of the ramp.</i></p>	Location	Length (inches)	a. Not used.		b. Not used.		c. Ramp to 2324 Erato	48 (approx)						
Location	Length (inches)														
a. Not used.															
b. Not used.															
c. Ramp to 2324 Erato	48 (approx)														
<p>9</p>  <p><i>Running slope at ramp to 2410 Erato.</i></p>	<p>Running slopes of ramps are more than 8.3% (maximum 8.3% allowed).</p> <table border="1" data-bbox="703 1440 1279 1766"> <thead> <tr> <th data-bbox="703 1478 821 1507">Location</th> <th data-bbox="1073 1440 1187 1507">Running Slope</th> </tr> </thead> <tbody> <tr> <td data-bbox="703 1514 873 1543">a) Not used.</td> <td></td> </tr> <tr> <td data-bbox="703 1549 1008 1579">b) Ramp to 2324 Erato</td> <td data-bbox="1084 1549 1166 1579">15.0%</td> </tr> <tr> <td data-bbox="703 1585 1008 1614">c) Ramp to 2306 Erato</td> <td data-bbox="1101 1585 1166 1614">9.5%</td> </tr> <tr> <td data-bbox="703 1621 1057 1650">d) Ramp to 1204 Freret St.</td> <td data-bbox="1101 1621 1170 1650">11.5%</td> </tr> <tr> <td data-bbox="703 1656 1057 1686">e) Ramp to 1202 Freret St.</td> <td data-bbox="1101 1656 1170 1686">13.9%</td> </tr> <tr> <td data-bbox="703 1692 1170 1766">f) Ramp to 1214 Rev. John Raphael Jr. Way</td> <td data-bbox="1101 1692 1170 1722">10.4%</td> </tr> </tbody> </table> <p>A maximum 8.3% (1:12) running slope is allowed. (Guidelines Requirement 1; Guidelines Requirement 2; ANSI 1986 4.8.2).</p>	Location	Running Slope	a) Not used.		b) Ramp to 2324 Erato	15.0%	c) Ramp to 2306 Erato	9.5%	d) Ramp to 1204 Freret St.	11.5%	e) Ramp to 1202 Freret St.	13.9%	f) Ramp to 1214 Rev. John Raphael Jr. Way	10.4%
Location	Running Slope														
a) Not used.															
b) Ramp to 2324 Erato	15.0%														
c) Ramp to 2306 Erato	9.5%														
d) Ramp to 1204 Freret St.	11.5%														
e) Ramp to 1202 Freret St.	13.9%														
f) Ramp to 1214 Rev. John Raphael Jr. Way	10.4%														

		<p><i>Retrofit:</i></p> <p><i>Where slopes in excess of 8.3% affect a small area (less than 12”x 12”), grinding the existing surface may be a useful retrofit method. If grinding is extensive or insufficient to bring the ramp slopes within the required maximum of 8.3%, remove and replace the ramp. New concrete ramp(s) to comply with 2% cross slope, 8.3% running slope, top and bottom landing requirements (both dimensional and in terms of slopes), handrails and edge protection.</i></p>						
<p>10</p>	 <p><i>Ramp to 1217 Rv. John Raphael Way (measuring running slope).</i></p>  <p><i>Slope at ramp to 1217 Rev. John Raphael Jr. Way.</i></p>	<p>Cross slopes of ramps are more than 2% (maximum 2% allowed).</p> <table border="1" data-bbox="703 768 1279 840"> <thead> <tr> <th>Location</th> <th>Cross Slope</th> </tr> </thead> <tbody> <tr> <td>a) Not used.</td> <td></td> </tr> <tr> <td>b) Ramp to 1217 Rev. John Raphael Jr. Way</td> <td>4.5%</td> </tr> </tbody> </table> <p>A maximum 2% cross slope is allowed at an accessible route. (Guidelines Requirement 1, Guidelines Requirement 2, ANSI 1986 4.3.7).</p> <p><i>Retrofit:</i></p> <p><i>Where slopes in excess of 8.3% affect a small area, grinding the existing surface may be a useful retrofit method. If grinding is extensive or insufficient to bring the ramp slopes within the required maximum of 8.3%, remove and replace the ramp. New concrete ramp to comply with 2% cross slope, 8.3% running slope, top and bottom landing requirements (both dimensional and in terms of slopes), handrails and edge protection.</i></p>	Location	Cross Slope	a) Not used.		b) Ramp to 1217 Rev. John Raphael Jr. Way	4.5%
Location	Cross Slope							
a) Not used.								
b) Ramp to 1217 Rev. John Raphael Jr. Way	4.5%							

<b>Inaccessible Door and Gate Maneuvering Clearances</b>										
<p>11</p>  <p><i>Approach to gate to parking and back of Bldg. M.</i></p>		<p>Gate maneuvering clearance on the pull side is less than 18 inches (minimum 18 inches required).</p> <table border="1" data-bbox="706 394 1279 430"> <thead> <tr> <th data-bbox="706 394 1096 430"><u>Location</u></th> <th data-bbox="1096 394 1279 430"><u>Width</u></th> </tr> </thead> <tbody> <tr> <td data-bbox="706 430 1096 577">Gate to Parking behind Bldg. M – off S. Liberty St. Surface ends 12 short of the gate and jamb.</td> <td data-bbox="1096 430 1279 577">12</td> </tr> </tbody> </table> <p>A minimum 18 inches of clear floor space is required next to the latch on the pull side of the door or gate with a front approach. (Guidelines Requirement 1, Guidelines Requirement 2, ANSI 1986 4.13.6, ANSI 1986 Figure 25(a)).</p> <p><i>Retrofit:</i>  <i>Install new concrete adjacent to existing to create an 18” wide maneuvering area 60” long so that a wheelchair user can center on the gate hardware to open and maneuver around the gate on the pull side.</i></p>	<u>Location</u>	<u>Width</u>	Gate to Parking behind Bldg. M – off S. Liberty St. Surface ends 12 short of the gate and jamb.	12				
<u>Location</u>	<u>Width</u>									
Gate to Parking behind Bldg. M – off S. Liberty St. Surface ends 12 short of the gate and jamb.	12									
<p>12</p>  <p><i>1204 Freret back door/accessible entry from parking.</i></p>		<p>Door and gate maneuvering clearances have slopes as steep as 4.2% (maximum 2% allowed).</p> <table border="1" data-bbox="706 1171 1279 1207"> <thead> <tr> <th data-bbox="706 1171 1015 1207"><u>Location</u></th> <th data-bbox="1015 1171 1279 1207"><u>Slope</u></th> </tr> </thead> <tbody> <tr> <td data-bbox="706 1207 1015 1243">a) Not used.</td> <td data-bbox="1015 1207 1279 1243"></td> </tr> <tr> <td data-bbox="706 1243 1015 1318">b) 1215 Rev. John Raphael Jr. Way</td> <td data-bbox="1015 1243 1279 1318">3.6%</td> </tr> <tr> <td data-bbox="706 1318 1015 1394">c) 1224 Rev. John Raphael Jr. Way</td> <td data-bbox="1015 1318 1279 1394">4.2%</td> </tr> </tbody> </table> <p>A level and clear floor area is required within maneuvering clearances at doors and gates. (Guidelines Requirement 1; Guidelines Requirement 2; ANSI 1986 4.13.6).</p> <p><i>Retrofit:</i>  <i>Where slopes in excess of 2.0% affect a small area, grinding the existing surface may be a useful retrofit method. If grinding is extensive or insufficient to bring the ramp slopes within the required maximum of 2.0%, remove and replace the concrete at the door/gate maneuvering space. New concrete paving to comply with</i></p>	<u>Location</u>	<u>Slope</u>	a) Not used.		b) 1215 Rev. John Raphael Jr. Way	3.6%	c) 1224 Rev. John Raphael Jr. Way	4.2%
<u>Location</u>	<u>Slope</u>									
a) Not used.										
b) 1215 Rev. John Raphael Jr. Way	3.6%									
c) 1224 Rev. John Raphael Jr. Way	4.2%									

	 <p><i>Slope at 1204 Freret back door.</i></p>	<p><i>2% cross slope, 2.0% running slope and dimensional requirements.</i></p>
	<p><b>Inaccessible Door Hardware at Common Area and Unit Entrances</b></p>	
<p>13</p>	<p><i>Not used.</i></p>	
<p>14</p>	 <p><i>Gate at Building M, SE corner.</i></p>	<p>No clear space provided for approach and use of fob sensor at gate to parking area at Building M, SE corner (clear floor space for parallel approach is required, fob panel is 52-1/2 inches above the grass.)</p> <p>A level and clear 30 inch by 48 inch floor area is required at controls and operating mechanisms. (Guidelines Requirement 2, ANSI 1986 4.2.4.1, ANSI 1986 4.25.2).</p> <p><i>Retrofit:</i></p> <p><i>Install new concrete adjacent to existing to create a 30" x 48" minimum slab, with maximum 2% slope in any direction, to provide a side approach for a wheelchair user to be able to reach the fob sensor (48" side must be centered on fob sensor).</i></p>



Inaccessible Thresholds								
<p>15</p>	 <p><i>Exterior threshold at front door Bldg. M.</i></p>	<p>Building entry door exterior thresholds are more than 3/4 inches high.</p> <table border="0" data-bbox="706 346 1274 493"> <thead> <tr> <th style="text-align: left;"><u>Location</u></th> <th style="text-align: left;"><u>Total Height (inches)</u></th> </tr> </thead> <tbody> <tr> <td>Building M - front</td> <td>7/8</td> </tr> <tr> <td>Building M back (parking)</td> <td>7/8</td> </tr> </tbody> </table> <p>A maximum 3/4 inch beveled threshold is allowed. (Guidelines Requirement 2; Guidelines Requirement 4(4); ANSI 1986 4.13.8).</p> <p><i>Retrofit:</i></p> <p><i>Remove existing thresholds, and replace with a “low” ADA compliant threshold providing a maximum height of 3/4”. (This may require making some adjustments to existing doors.)</i></p>	<u>Location</u>	<u>Total Height (inches)</u>	Building M - front	7/8	Building M back (parking)	7/8
<u>Location</u>	<u>Total Height (inches)</u>							
Building M - front	7/8							
Building M back (parking)	7/8							
<p>16</p>	 <p><i>Threshold and change in level at primary entrance threshold exterior side, 2410 Erato.</i></p>	<p>Building Types G and H entrance thresholds and changes in level are more than 3/4 inches high and are not beveled (maximum 3/4 inch allowed, maximum 1:2 bevel required).</p> <p>A maximum 3/4 inch high threshold with a maximum 1:2 bevel is allowed. (Guidelines Requirement 2; Guidelines Requirement 4(4); ANSI 1986 4.13.8). At primary entry doors with direct exterior access, outside landing surfaces may be 1/2 inch below the floor level of the unit. (Guidelines Requirement 4(6)).</p> <p><i>Retrofits:</i></p> <ol data-bbox="755 1312 1404 1459" style="list-style-type: none"> <li><i>a) Replace the threshold with a compliant type,</i></li> <li><i>b) Install an aluminum 1:12 bevel for the existing threshold, or</i></li> <li><i>c) Remove and replace landing at door.</i></li> </ol> <p><i>Maximum threshold height 3/4 inch. Maximum vertical change in level 1/2 inch.</i></p>						



*Threshold and change in level at primary entrance threshold exterior side, 1212 Rev. John Raphael Jr. Way.*



*Threshold and change in level at primary entrance threshold exterior side, 1210 Rev. John Raphael Jr. Way.*

**B. Public and Common Use Areas**

	<b>Inaccessible Features at Building M Common Areas</b>	
17		<p>Building M common area room doors require more than 5 pounds of force to open:</p> <p>Fourth floor community room: 13 pounds  Second floor vending room: 10 pounds  Third floor vending room: 12 pounds  Fourth floor vending room: 10 pounds  Second floor trash room: 10 pounds  Third floor trash room: 11 pounds  Fourth floor trash room: 13 pounds required to open.  Note: trash room doors may be rated.</p> <p>A maximum 5 pound force is allowed to fully open a door (other than a fire door). (Guidelines Requirement 2, ANSI 1986 4.13.11).</p>
18		<p>Building M common area room doors close in less than the minimum time required (minimum 3 seconds to an open position of approximately 12 degrees):</p> <p>Fourth floor community room: 2 seconds to fully closed.  Second floor vending room: 3 seconds to fully closed.  Third floor vending room: 2.5 seconds to fully closed.  Fourth floor vending room: 3 seconds to fully closed.  Second floor trash room: 3 seconds to fully closed.  Third floor trash room: 2 seconds to fully closed.  Fourth floor trash room: 2 seconds to fully closed.</p> <p>A minimum 3 second closing time is required when a door in an open position of 90 degrees closes to an open position of 12 degrees. (Guidelines Requirement 2, ANSI 1986 4.13.10).</p> <p><i>Retrofit:</i>  <i>Door closers will be adjusted to reduce closing speed.</i></p>



19



*Vending machine at fourth floor, Bldg. M.*



*Height of payment slot at second floor machine.*





*Height of payment slot at third floor machine*



The payment slot at the second, third and fourth floor vending machines by the windows are 54 to 54-3/4 inches above the floor (maximum 48 inches allowed for forward approach).

A maximum 48 inch height is allowed for the front reach range where the space below the control is unobstructed. (Guidelines Requirement 2, ANSI 1986 4.2.5).

*Retrofit:*

*Relocate vending machines to a minimum of 24" from the side wall so that a side approach is possible. It is possible that the 54-3/4" height is due to the "leveling guides" on the bottom of the vending machine being set too high. Verify that these "feet" are set to their lowest position before leveling the machine.*

<p><b>Building M – Inaccessible Features at Fourth Floor Common Area Restrooms</b></p>								
<p>20</p>	 <p><i>Distance from side wall to toilet centerline.</i></p>	<p>The east unisex toilet centerline is 19.5 inches from the side wall (maximum 18 inches allowed).</p> <p>A distance of 18 inches is required between the toilet centerline and the side wall. (Guidelines Requirement 2, ANSI 1986 4.22.3; ANSI 1986 4.16.2; ANSI 1986 Figure 28).</p> <p><i>Retrofit:</i></p> <p><i>Remove accessories and base from wall, install wood furring and drywall to bring surface of wall to 18" from the toilet centerline. Re-install side wall grab bar, toilet paper dispenser and base. (Coordinate work with item 21 below.)</i></p> <p><i>Note: location of rear grab bar may be affected by this work. Rear grab bar may need relocation.</i></p>						
<p>21</p>	 <p><i>East unisex restroom side grab bar.</i></p>	<p>Side grab bars at both the toilets extend 48-5/8 inches to 48-3/4 inches from the back wall (minimum 54 inches required).</p> <table border="1" data-bbox="706 1182 1279 1329"> <thead> <tr> <th data-bbox="706 1224 824 1255"><u>Location</u></th> <th data-bbox="1060 1182 1239 1255"><u>Dimension in Inches</u></th> </tr> </thead> <tbody> <tr> <td data-bbox="706 1255 979 1287">East unisex restroom</td> <td data-bbox="1060 1255 1149 1287">48-3/4</td> </tr> <tr> <td data-bbox="706 1287 979 1318">West unisex restroom</td> <td data-bbox="1060 1287 1149 1318">48-5/8</td> </tr> </tbody> </table> <p>Grab bars at toilet side walls are to extend a minimum of 12 inches plus 42 inches (54 inches) from the back wall. (Guidelines Requirement 2, ANSI 1986 4.16.4, ANSI 1986 Figure 29 (b)).</p> <p><i>Retrofit:</i></p> <p><i>Remove and re-install side grab bar, starting 12" from rear wall, so that the end of grab bar extends the required 54" from the rear wall. (42" grab bar + 12" = 54")</i></p>	<u>Location</u>	<u>Dimension in Inches</u>	East unisex restroom	48-3/4	West unisex restroom	48-5/8
<u>Location</u>	<u>Dimension in Inches</u>							
East unisex restroom	48-3/4							
West unisex restroom	48-5/8							

	<p><b>Inaccessible Features at Exterior Mail Boxes</b></p>	
<p>22</p>	 <p><i>Mail with box for Unit 2017 S. Liberty</i></p>  <p><i>Box serving Unit 2017 S. Liberty.</i></p>	<p>The mailbox serving Unit 1217 S. Liberty has a lock at 71-1/2 inches above the adjacent concrete (maximum 54 inches allowed).</p> <p>A maximum 54 inch height is allowed for the side reach range where the space below the element is unobstructed. (Guidelines Requirement 2, ANSI 1986 4.2.6).</p> <p><i>Retrofit:</i></p> <p><i>Permanently relocate 1217 S. Liberty's assigned mailbox to a box location at or lower than 54" above the adjacent slab.</i></p>
	<p><b>Building M - Inaccessible Mail Center Features</b></p>	
<p>23</p>	 <p><i>Mail Center at Building M</i></p>	<p>Of 49 mailboxes, 20 mailbox locations serve covered units and are above reach range (maximum 54 inches allowed). The top four rows of boxes are 66-1/2 inches, 63-1/4 inches, 59-3/4 inches and 56-1/4 inches above the floor. All four top rows are more than 54 inches above the floor.</p> <p>Units with mailboxes with locks more than 54 inches above the floor: 101, 103, 104, 105, 113, 201, 202, 203, 209, 210, 211, 212, 307, 308, 309, 310, 404, 406, 407 and 408.</p> <p>A maximum 54 inch height is allowed for the side reach range where the space below the element is unobstructed. (Guidelines Requirement 2, ANSI 1986 4.2.6).</p>



*Height of top four rows of boxes.*

*A second bank of mailboxes will be added elsewhere in the mailroom to provide sufficient mailboxes within the 54" maximum side reach range for all FHA covered units. (Mailboxes above 54" will be left vacant and have a blank door, since all units in an elevator building are covered units.)*

*UFAS (accessible) unit mailboxes are required to be no more than 48" above the floor to the lock.*

**C. Inaccessible Features at Covered Dwelling Units**

Guste III has 44 buildings with 155 units, 65 of which are covered dwelling units required to comply with the FHAA.

There are 16 ground floor units in Building Types G, G1 and H are covered units required to comply with the FHAA. Building M has 49 units. The building has four stories and an elevator serving all levels. All 49 units in the building are covered and required to comply with the FHAA.





**BUILDING M - UNIT TYPE A: 2 Bedroom, 2 Bathroom**

Typical for 31 units. *Note: in units where the nose of the toilet in the hall bath is clear of the control wall of the tub, the hall bath may be evaluated as a Specification B bathroom and retrofits inside the master bath can be omitted.*



*Plan for Building M, Unit Type A*

	<b>Inaccessible Unit Features</b>	
24	 <p><i>Balcony door opening.</i></p>	<p>Balcony door clear opening widths are 21-1/4 inches wide for a one door leaf (minimum 31-5/8 inches required). The latching mechanism for the second door is 72 inches above the floor (maximum 54 inches required for operating parts).</p> <p>A minimum 32 inches nominal clear opening width (31-5/8 inches) is required for doors intended for user passage. (Guidelines Requirement 3(2)).</p> <p><i>Retrofit:</i>  <i>Remove the double door unit and replace with a 36" swinging door (which will provide sufficient clear width), and an inoperable sidelight.</i></p>





		
		
<p>25</p>		<p>Thermostat top controls are 49-7/8 inches above the floor (maximum 48 inches allowed).</p> <p>A minimum 15 inches is required and a maximum 48 inches is allowed for the reach range where the space below the control is unobstructed. (Guidelines Requirement 5).</p> <p><i>Retrofit:</i>  <i>Remove thermostats, adjust wiring and re-install thermostats so that the highest operable part is no more than 48" above the floor. Patch prior location. As an alternative, find a replacement thermostat that provides controls lower on the thermostat, so that existing location / wiring may be used.</i></p>
		

*Clear width of door opening.*

*Height of upper latch at second door*

*Unit 110 thermostat*

*Unit 404 thermostat*

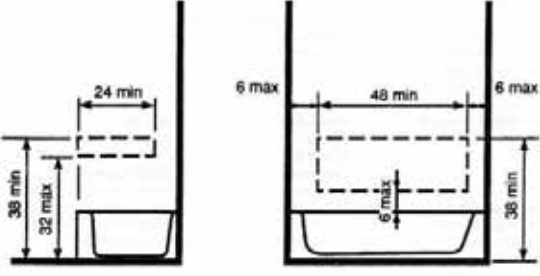
	 <p data-bbox="289 493 527 520"><i>Unit 409 thermostat</i></p>	
<p data-bbox="203 531 240 562">26</p>	 <p data-bbox="289 934 641 966"><i>Unit 110 hall tub surround</i></p>  <p data-bbox="289 1228 673 1260"><i>Unit 110 master tub surround</i></p>  <p data-bbox="289 1543 641 1575"><i>Unit 404 hall tub surround</i></p>  <p data-bbox="289 1858 673 1890"><i>Unit 404 master tub surround</i></p>	<p data-bbox="706 541 1437 682">The shape of the tub and shower surrounds at both bathtubs preclude the installation of future grab bars with firm attachment to blocking on the long wall of the tubs (ability to install grab bars required).</p>  <p data-bbox="836 997 1274 1060"><b>Fig. 4 Location of Grab Bar Reinforcements for Adaptable Bathtubs</b></p> <p data-bbox="706 1092 1404 1197">Reinforcement is required for the future installation of grab bars and shower seats at toilets, bathtubs and shower compartments. (Guidelines Requirement 6).</p> <p data-bbox="706 1228 828 1260"><i>Retrofits:</i></p> <p data-bbox="706 1281 885 1312"><i>At hall baths:</i></p> <p data-bbox="706 1333 1437 1480"><i>Obtain a copy of tub surround manufacturer’s product data and specifications including information concerning fiberglass wall thickness and any integral blocking provided during the fabrication of the surround.</i></p> <p data-bbox="706 1480 1412 1627"><i>Investigate with manufacturer to determine if this issue has been solved previously and if so, how. Submit product data and any proposed retrofit to DOJ for review.</i></p> <p data-bbox="706 1648 1429 1795"><i>If a compliant retrofit for the installed product is not possible, remove and replace tub surround with one that allows correct future installation of grab bars. In the process, verify blocking installation.</i></p> <p data-bbox="706 1806 917 1837"><i>At master baths:</i></p>



		<p><i>If hall bath toilet overlaps the required clear floor space for approach to the hall tub control wall (Specification B), retrofit master bath tub as described above.</i></p>
<p>27</p>	 <p><i>Unit 110 toilet and tub.</i></p>  <p><i>Hall bathroom toilet dimension from side wall to toilet centerline.</i></p>  <p><i>Master bathroom toilet dimension from side wall to toilet centerline.</i></p>	<p>Toilet centerlines are 16-3/8 to 16-1/2 inches to the side wall on the side opposite the direction of approach (minimum 18 inches required).</p> <p>A minimum 18 inches is required between the toilet centerline and the adjacent wall, bathtub or lavatory on the side opposite the direction of approach. (Guidelines Requirement 7 (2)(a)(ii)), Figure 7(a)).</p> <p><i>Retrofits:</i></p> <p><i>At hall baths:</i></p> <p><i>Remove toilet, correct plumbing, and re-install toilet 18" minimum from the tub / sidewall. (In some cases, an offset flange, or repositioning on the existing flange may be possible.)</i></p> <p><i>At master baths:</i></p> <p><i>If hall bath toilet overlaps the required clear floor space for approach to the hall tub control wall (Specification B), retrofit master bath toilet as described above as is required.</i></p>
<p>28</p>		<p>Lavatory centerline is 13 inches to the side wall in unit 409 hall bath (minimum 24 inches required).</p> <p>The 48 inches minimum parallel approach provided must be centered on the lavatory. (Guidelines Requirement 7 (2)(a)(ii)), Figure 7(c)).</p> <p><i>Retrofits:</i></p>



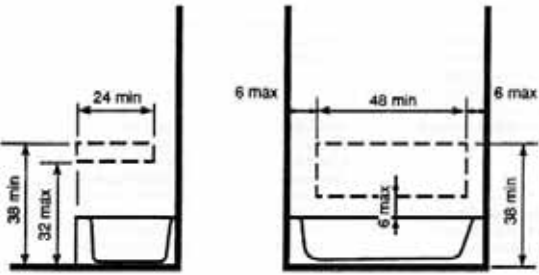

		<p><i>Remove thermostat, adjust wiring and re-install thermostats so that the highest operable part is no more than 48" above the floor. Patch prior location. As an alternative, find a replacement thermostat that provides controls lower on the thermostat, so that existing location / wiring may be used.</i></p>
<p>30</p>	 <p><i>Unit 407 tub surround</i></p>	<p>The shape of the tub and shower surrounds at the bathtub preclude the installation of future grab bars with firm attachment to blocking on the long wall of the tubs (ability to install grab bars required).</p>  <p><b>Fig. 4 Location of Grab Bar Reinforcements for Adaptable Bathtubs</b></p> <p>Reinforcement is required for the future installation of grab bars and shower seats at toilets, bathtubs and shower compartments. (Guidelines Requirement 6).</p> <p><i>Retrofit:</i></p> <p><i>Obtain a copy of tub surround manufacturer's product data and specifications, including information concerning fiberglass wall thickness and any integral blocking provided during the fabrication of the surround. Investigate with manufacturer to determine if this issue has been solved previously and if so, how. Submit product data and any proposed retrofit to DOJ for review.</i></p> <p><i>If a compliant retrofit for the installed product is not possible, remove and replace tub surround with one that allows correct future installation of grab bars. In the process, verify blocking installation.</i></p>

**BUILDING M - UNIT TYPE B: 2 Bedroom, 2 Bathroom**

Typical for 4 units.

Unit Type B is designed to comply with UFAS accessibility requirements. This evaluation addresses only FHAA requirements.

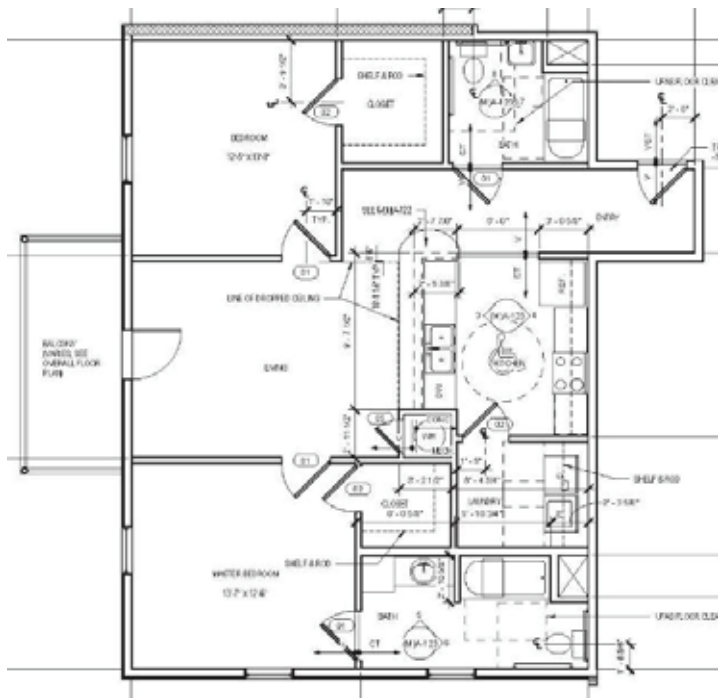

Plan for Building M, Unit Type B

	<b>Inaccessible Unit Features</b>	
31	 <p>Unit 213 thermostat</p>	<p>Thermostat top controls are 49 inches above the floor (maximum 48 inches allowed).</p> <p>A minimum 15 inches is required and a maximum 48 inches is allowed for the reach range where the space below the control is unobstructed. (Guidelines Requirement 5).</p> <p><i>Retrofit:</i></p> <p><i>Remove thermostat, adjust wiring and re-install thermostats so that the highest operable part is no more than 48" above the floor. Patch prior location. As an alternative, find a replacement thermostat that provides controls lower on the thermostat, so that existing location / wiring may be used.</i></p>

<i>Unit 113 thermostat</i>	
----------------------------	--

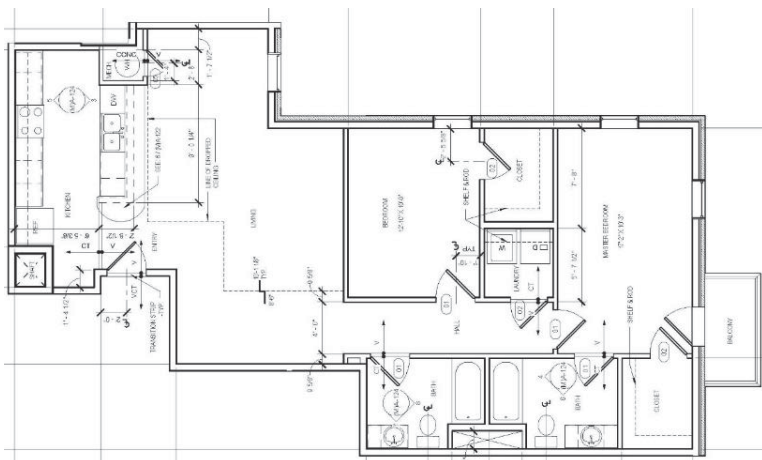

**BUILDING M - UNIT TYPE C: 2 Bedroom, 2 Bathroom**

Typical for 4 units.



*Plan for Building M, Unit Type C*

	<b>Inaccessible Unit Features</b>	
32	 <p><i>Balcony deck/door threshold and change in level.</i></p>	<p>The exterior deck is 3/4 inch below the interior floor level (maximum 1/2 inch with bevel allowed).</p> <p>Exterior deck or balcony surfaces may be no more than 1/2 inch below the floor level of the dwelling unit. (Guidelines Requirement 4 (5)).</p> <p><i>Retrofit:</i>  <i>Pull up deck boards, and “shim” underneath with minimum 1/4” material. Re-install deck boards.</i></p>
33	<p><i>See above.</i></p>	<p>The change in level at the exterior door to the deck is vertical and is not beveled at a slope no greater than 1:2 (maximum 1:2 bevel allowed).</p> <p>Thresholds and changes in level at exterior doors must be beveled with a slope no greater than 1:2. (Guidelines Requirement 4 (4)).</p>

		<p><i>Retrofit:</i></p> <p><i>If the deck slope is less than 2%, investigate raising the deck boards near the threshold up, by as much as a 1/4 inch. Maintain a maximum 2% slope across the deck and add a bevel, maximum 1:2 slope, to the edge of the threshold. Note: a 1/4 inch vertical face is acceptable at the threshold.</i></p> <p><i>If slope is already 2%, if raising the boards will result in a slope greater than 2%, or if raising the deck boards will not result in a threshold maximum height of 3/4 inches, then the deck boards must be removed and shimmed accordingly in front of this door, tapering out from door. The maximum threshold height is to be 3/4 inches, with a maximum 1/4 inch vertical face at threshold, and a 1:2 bevel at the remaining maximum 1/2 inch transition.</i></p>
<p>34</p>	 <p><i>Unit 412 thermostat</i></p>	<p>Thermostat top controls are 49 inches above the floor (maximum 48 inches allowed).</p> <p>A minimum 15 inches is required and a maximum 48 inches is allowed for the reach range where the space below the control is unobstructed. (Guidelines Requirement 5).</p> <p><i>Retrofit:</i></p> <p><i>Remove thermostat, adjust wiring and re-install thermostats so that the highest operable part is no more than 48" above the floor. Patch prior location. As an alternative, find a replacement thermostat that provides controls lower on the thermostat, so that existing location / wiring may be used.</i></p>
<p>35</p>	 <p><i>Unit 412 tub surround.</i></p>	<p>The shape of the tub and shower surrounds at both bathtubs preclude the installation of future grab bars with firm attachment to blocking on the long wall of the tubs (ability to install grab bars required).</p>



*Height of ledges at back wall.*



*Shape and length of side wall extrusions.*

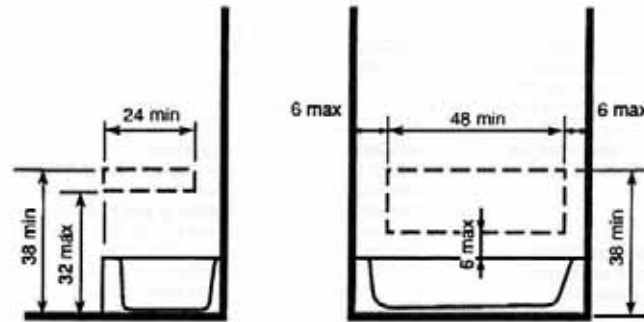

**Fig. 4 Location of Grab Bar Reinforcements for Adaptable Bathtubs**

Reinforcement is required for the future installation of grab bars and shower seats at toilets, bathtubs and shower compartments. (Guidelines Requirement 6).

**Retrofit:**

*Obtain a copy of tub surround manufacturer’s product data and specifications, including information concerning fiberglass wall thickness and any integral blocking provided during the fabrication of the surround. Investigate with manufacturer to determine if this issue has been solved previously and if so, how. Submit product data and any proposed retrofit to DOJ for review.*

*If a compliant retrofit for the installed product is not possible, remove and replace tub surround with one that allows correct future installation of grab bars. In the process, verify blocking installation.*

36



*Hall toilet centerline from vanity in unit 412.*

Toilet centerlines are 13-3/4 inches to the vanity cabinet in the direction of approach (minimum 15 inches required).

A minimum 15 inch distance is required between the toilet centerline and the vanity in the direction of approach for use of the toilet. (Guidelines Requirement 7 (2)(a)(ii) and Figure 7(a)).

**Retrofit:**

*Remove toilet, correct plumbing, and re-install toilet 18” from the tub / sidewall and minimum 15 inches from the vanity cabinet. (In some cases, an offset flange, or repositioning on the existing flange may be possible.)*



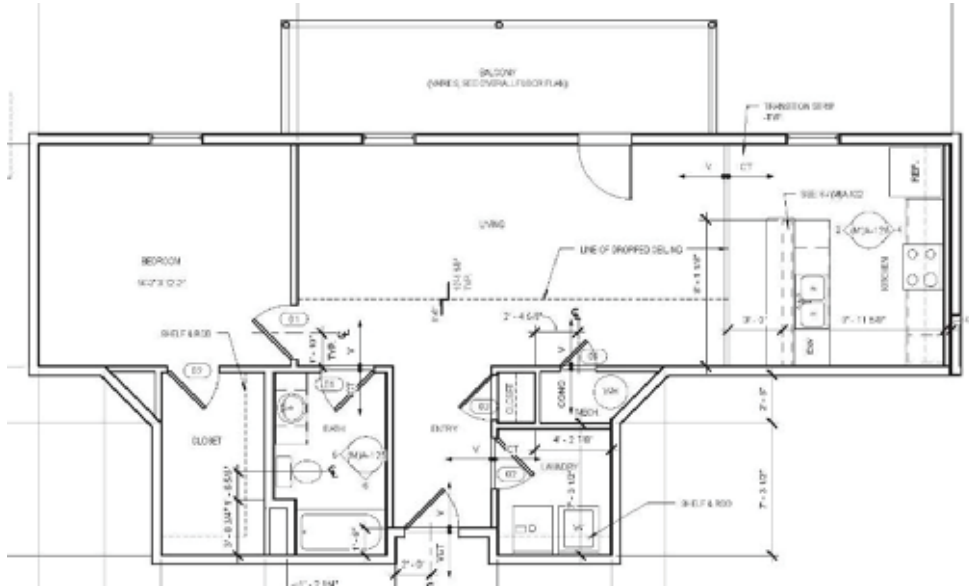

**BUILDING M - UNIT TYPE D: 2 Bedroom, 1 Bathroom**

Typical for 3 units.



Plan for Building M, Unit Type D

	<b>Inaccessible Unit Features</b>	
37	 <p data-bbox="289 1606 672 1675"><i>Balcony deck/door threshold and level change.</i></p>	<p data-bbox="703 1094 1433 1167">The exterior deck is 1 inch below the interior floor level (maximum 1/2 inch with bevel allowed).</p> <p data-bbox="703 1192 1382 1304">Exterior deck surfaces may be no more than 1/2 inch below the floor level of the interior. (Guidelines Requirement 4(5)).</p> <p data-bbox="703 1329 813 1360"><i>Retrofit:</i></p> <p data-bbox="703 1375 1433 1627"><i>Check the slope of the deck boards in this area. If the deck slope is less than 2%, investigate raising the deck boards near the threshold up, by as much as a 1/4 inch. Maintain a maximum 2% slope across the deck and add a bevel, maximum 1:2 slope, to the edge of the threshold. Note: a 1/4 inch vertical face is acceptable at the threshold.</i></p> <p data-bbox="703 1644 1433 1892"><i>If slope is already 2%, if raising the boards will result in a slope greater than 2%, or if raising the deck boards will not result in a threshold maximum height of 3/4 inches, then the deck boards must be removed and shimmed accordingly in front of this door, tapering out from door. The maximum threshold height is to be 3/4 inches, with a maximum 1/4 inch vertical face at</i></p>

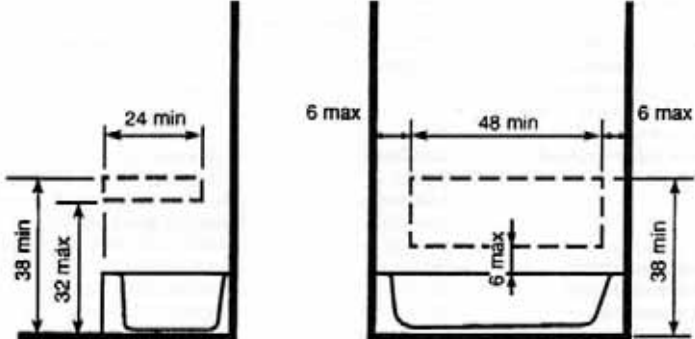
		<p>threshold, and a 1:2 bevel at the remaining maximum 1/2 inch transition.</p>
<p>38</p>	<p>See above.</p>	<p>The change in level at the exterior door to the deck is vertical and is not beveled at a slope no greater than 1:2 (maximum 1:2 bevel allowed). See photo above.</p> <p>Thresholds and changes in level at exterior doors must be beveled with a slope no greater than 1:2. (Guidelines Requirement 4 (4)).</p> <p><i>Retrofit:</i>  <i>Install a bevel sloped 1:2 (twice as deep as it is tall) in front of threshold.</i></p>
<p>39</p>	 <p>Unit 305 tub surround</p> <p>Unit 105 tub surround</p>	<p>The shape of the tub and shower surrounds at both bathtubs preclude the installation of future grab bars with firm attachment to blocking on the long wall of the tubs (ability to install grab bars required).</p>  <p>Fig. 4 Location of Grab Bar Reinforcements for Adaptable Bathtubs</p> <p>Reinforcement is required for the future installation of grab bars and shower seats at toilets, bathtubs and shower compartments. (Guidelines Requirement 6).</p> <p><i>Retrofit:</i>  <i>Obtain a copy of tub surround manufacturer's product data and specifications, including information concerning fiberglass wall thickness and any integral blocking provided during the fabrication of the surround. Investigate with manufacturer to determine if this issue has been solved previously and if so, how. Submit</i></p>



<p><i>Unit 205 tub surround</i></p>	<p><i>product data and any proposed retrofit to DOJ for review.</i></p> <p><i>If a compliant retrofit for the installed product is not possible, remove and replace tub surround with one that allows correct future installation of grab bars. In the process, verify blocking installation.</i></p>
-------------------------------------	---

**BUILDING M - UNIT TYPE E: 3 Bedroom, 2 Bathroom**

Typical for one unit. Unit Type E is designed to comply with UFAS accessibility requirements. This evaluation addresses only FHAA requirements.

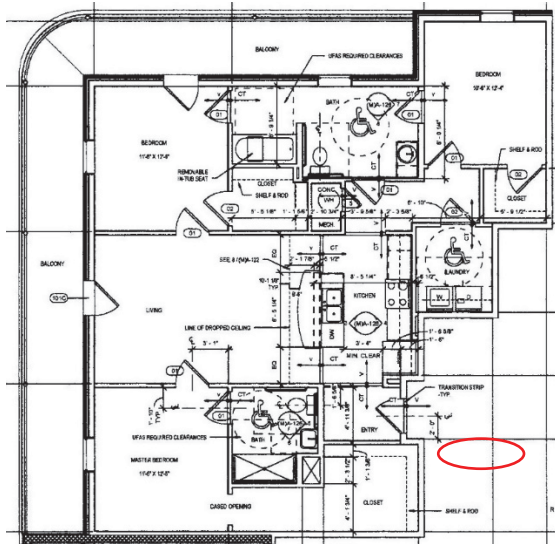

*Plan for Building M, Unit Type E*

	<p><b>Inaccessible Unit Features</b></p>	
<p>40</p>	 <p><i>Kitchen clearance at refrigerator / cabinet</i></p>	<p>The clearance between refrigerator and island cabinet is 36”, as shown in photo on left.</p> <p>Clearance between counters and all opposing base cabinets, countertops, appliances, or walls is at least 40 inches. (Guidelines Requirement 7(1)(b)).</p> <p><i>First try to reposition refrigerator fully against wall. If that is not the case, replace existing refrigerator with one that is “counter depth”.</i></p>

**BUILDING M - UNIT TYPE F: 2 Bedroom, 2 Bathroom**

Typical for one unit. No inaccessible FHAA required features found.

**BUILDING M - UNIT TYPE G: 2 Bedroom, 2 Bathroom**

Typical for one unit. Unit Type G is designed to comply with UFAS accessibility requirements. This evaluation addresses only FHAA requirements.

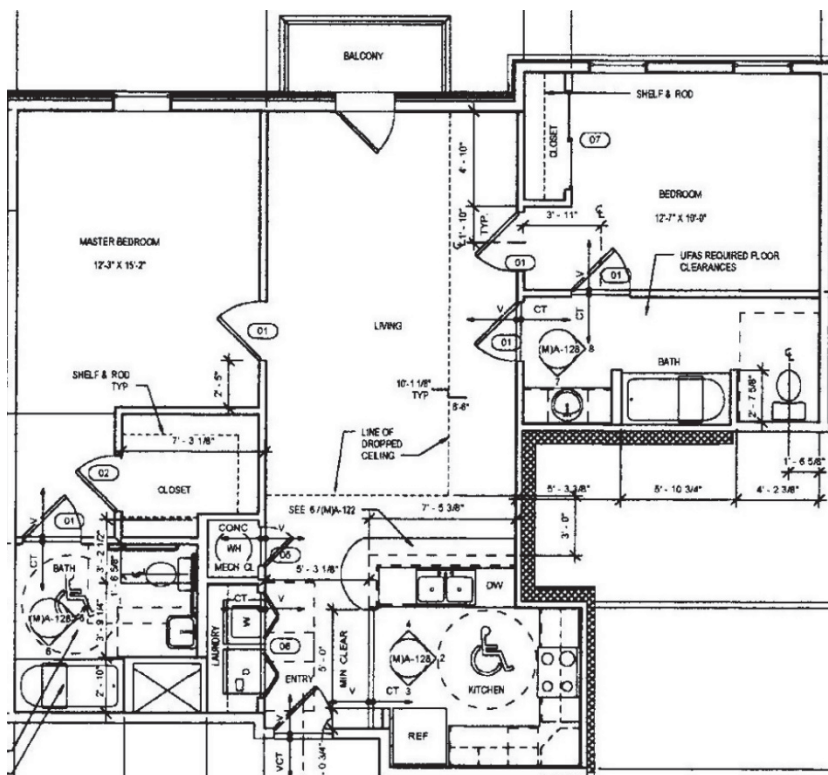

Plan for Building M, Unit Type G



	<b>Inaccessible Unit Features</b>	
41	 <p data-bbox="289 1541 548 1570"><i>Unit 202 thermostat</i></p>	<p data-bbox="703 1245 1414 1314">Thermostat top controls are almost 49 inches above the floor (maximum 48 inches allowed).</p> <p data-bbox="703 1346 1386 1486">A minimum 15 inches is required and a maximum 48 inches is allowed for the reach range where the space below the control is unobstructed. (Guidelines Requirement 5).</p> <p data-bbox="703 1518 813 1547"><i>Retrofit:</i></p> <p data-bbox="703 1566 1422 1776"><i>Remove thermostat, adjust wiring and re-install thermostats so that the highest operable part is no more than 48" above the floor. Patch prior location. As an alternative, find a replacement thermostat that provides controls lower on the thermostat, so that existing location / wiring may be used.</i></p>

**BUILDING M - UNIT TYPE H: 3 Bedroom, 2 Bathroom**

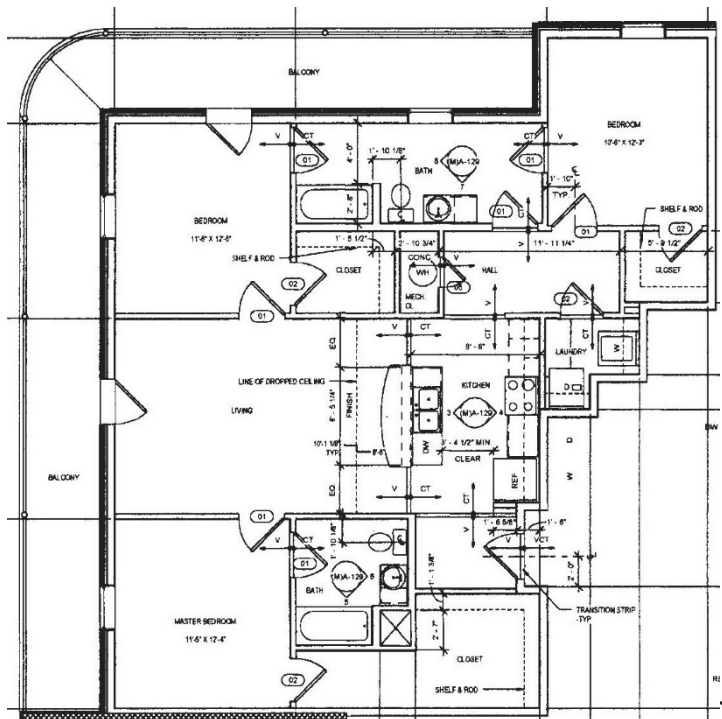
Typical for one unit. Note: Master bath does not meet clear floor space at toilet and lavatory, but unit has a Specification B bathroom, which exempts clear floor space in master bath.



Plan for Building M, Unit Type H

	<b>Inaccessible Unit Features</b>	
42	 <p><i>Balcony deck door threshold</i></p>	<p>The exterior threshold is 3/4 inch high going into bedroom 2 from balcony. (Maximum 1/4 inch allowed without bevel.)</p> <p>Thresholds at exterior doors are no higher than 3/4 inch. Thresholds and changes in level at these locations are beveled with a slope no greater than 1:2. (Guidelines Requirement 4 (4)).</p> <p><i>Retrofit:</i>                      Add a bevel, maximum 1:2 slope.</p>
43		<p>The exterior threshold 1 inch high going from living room onto balcony. (Maximum 1/4 inch allowed without bevel.)</p> <p>Thresholds at exterior doors are no higher than 3/4 inch. Thresholds and changes in level at these locations are beveled with a slope no greater than 1:2. (Guidelines Requirement 4 (4)).</p>

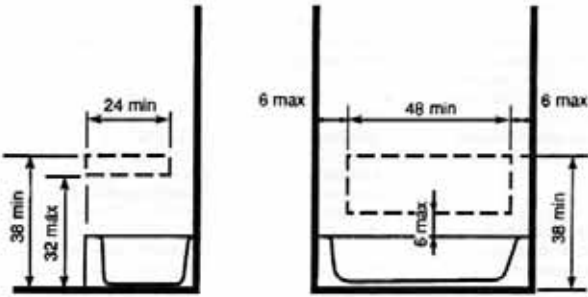
	<p><i>Balcony deck/door threshold</i></p>	<p><b>Retrofit:</b></p> <p><i>Check the slope of the deck boards in this area. If the deck slope is less than 2%, investigate raising the deck boards near the threshold up, by as much as a 1/4 inch. Maintain a maximum 2% slope across the deck and add a bevel, maximum 1:2 slope, to the edge of the threshold. Note: a 1/4 inch vertical face is acceptable at the threshold.</i></p> <p><i>If slope is already 2%, if raising the boards will result in a slope greater than 2%, or if raising the deck boards will not result in a threshold maximum height of 3/4 inches, then the deck boards must be removed and shimmed accordingly in front of this door, tapering out from door. The maximum threshold height is to be 3/4 inches, with a maximum 1/4 inch vertical face at threshold, and a 1:2 bevel at the remaining maximum 1/2 inch transition.</i></p>
<p>44</p>	 <p><i>Unit 301 master tub surround</i></p> <p><i>Unit 301 hall tub surround</i></p>	<p>The shape of the tub and shower surrounds at both bathtubs preclude the installation of future grab bars with firm attachment to blocking on the long wall of the tubs (ability to install grab bars required).</p>  <p><b>Fig. 4 Location of Grab Bar Reinforcements for Adaptable Bathtubs</b></p> <p>Reinforcement is required for the future installation of grab bars and shower seats at toilets, bathtubs and shower compartments. (Guidelines Requirement 6).</p> <p><b>Retrofit:</b></p> <p><i>Obtain a copy of tub surround manufacturer's product data and specifications including information concerning fiberglass wall thickness and any integral blocking provided during the fabrication of the surround. Investigate with manufacturer to determine if this issue has been solved previously and if so, how. Submit</i></p>

		<p><i>product data and any proposed retrofit to DOJ for review.</i></p> <p><i>If a compliant retrofit for the installed product is not possible, remove and replace tub surround with one that allows correct future installation of grab bars. In the process, verify blocking installation.</i></p>
--	--	---

**BUILDING M - UNIT TYPE J: 1 Bedroom, 1 Bathroom**

Typical for one unit.

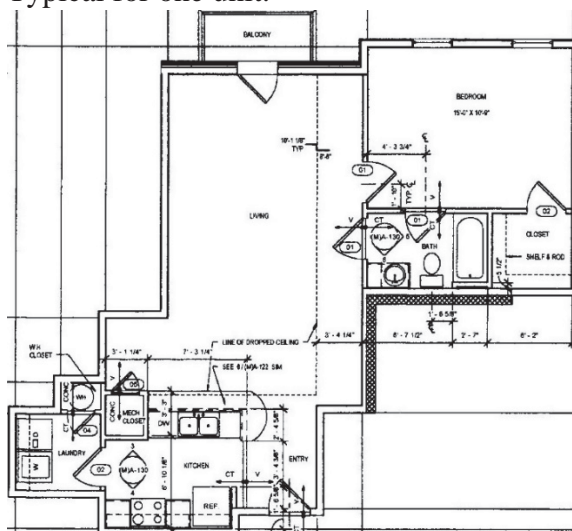

*Plan for Building M, Unit Type J*

	<b>Inaccessible Unit Features</b>	
45	 <p><i>Balcony deck/door threshold</i></p>	<p>The exterior threshold 1/4 inch high going from living room onto balcony. (Maximum 1/4 inch allowed without bevel.)</p> <p>Thresholds at exterior doors are no higher than 3/4 inch. Thresholds and changes in level at these locations are beveled with a slope no greater than 1:2. (Guidelines Requirement 4 (4)).</p> <p><i>Retrofit:</i></p> <p><i>Check the slope of the deck boards in this area. If the deck slope is less than 2%, investigate raising the deck boards near the threshold up, by as much as a 1/4 inch. Maintain a maximum 2% slope across the deck and add a bevel, maximum 1:2 slope, to the edge of the threshold. Note: a 1/4 inch vertical face is acceptable at the threshold.</i></p>

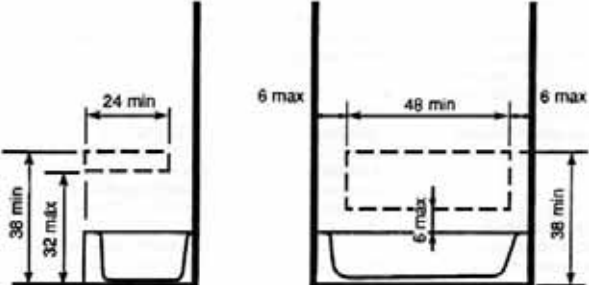

		<p><i>If slope is already 2%, if raising the boards will result in a slope greater than 2%, or if raising the deck boards will not result in a threshold maximum height of 3/4 inches, then the deck boards must be removed and shimmed accordingly in front of this door, tapering out from door. The maximum threshold height is to be 3/4 inches, with a maximum 1/4 inch vertical face at threshold, and a 1:2 bevel at the remaining maximum 1/2 inch transition.</i></p>
<p>46</p>	 <p><i>Unit 302 tub surround</i></p>	<p>The shape of the tub and shower surrounds in bathroom precludes the installation of future grab bars with firm attachment to blocking on the long wall of the tubs (ability to install grab bars required).</p>  <p><b>Fig. 4 Location of Grab Bar Reinforcements for Adaptable Bathtubs</b></p> <p>Reinforcement is required for the future installation of grab bars and shower seats at toilets, bathtubs and shower compartments. (Guidelines Requirement 6).</p> <p><b>Retrofit:</b></p> <p><i>Obtain a copy of tub surround manufacturer’s product data and specifications, including information concerning fiberglass wall thickness and any integral blocking provided during the fabrication of the surround. Investigate with manufacturer to determine if this issue has been solved previously and if so, how. Submit product data and any proposed retrofit to DOJ for review.</i></p> <p><i>If a compliant retrofit for the installed product is not possible, remove and replace tub surround with one that allows correct future installation of grab bars. In the process, verify blocking installation.</i></p>

47	 <p style="text-align: center;"><i>Unit 302 bath lavatory</i></p>	<p>Lavatory centerline is 13 inches to the side wall in unit 302 hall bath (minimum 24 inches required). (Vanity used was reversed from plans, placing drawers on toilet side and lavatory on wall side. Likely another unit has the same issue, in reverse.) (The 48" parallel approach provided, but not centered.)</p> <p>The 48 inches minimum parallel approach provided must be centered on the lavatory. (Guidelines Requirement 7 (2)(a)(ii)), Figure 7(c)).</p> <p><i>Retrofit:</i></p> <p><i>Remove lavatory and vanity and replace with a new or relocated vanity. Centerline of fixture to be at least 24 inches from the side wall.</i></p>
----	--	--

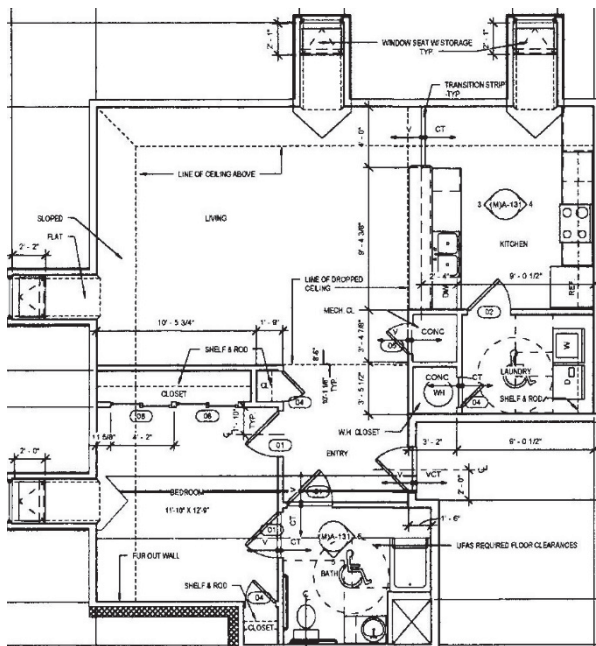

**BUILDING M - UNIT TYPE K: 1 Bedroom, 1 Bathroom**

Typical for one unit. Unit Type K is designed to comply with UFAS accessibility requirements. This evaluation addresses only FHAA requirements.



*Plan for Building M, Unit Type K*

	<b>Inaccessible Unit Features</b>	
--	-----------------------------------	--

48	 <p style="text-align: center;"><i>Entry coat closet depth</i></p>  <p style="text-align: center;"><i>Door opening width</i></p>	<p>Entry coat closet (by bedroom door) is 33” deep, and the door provides only 22” clear opening width. Because of closet depth, this should be a passage door.</p> <p>Within individual dwelling units, doors intended for user passage through the unit which have a clear opening width of at least 32 inches nominal width when the door is open 90 degrees, measured between the face of the door and the stop, would meet this requirement. (Guidelines Requirement 3(2)).</p> <p><i>Retrofit:</i>  <i>Closet is too narrow to widen door. Furr out rear wall of closet to reduce closet depth to 24” maximum.</i></p>
----	--	--

**“G” and “H” Fourplexes:**

**BUILDING TYPE G / H: 2 Bedroom Unit**

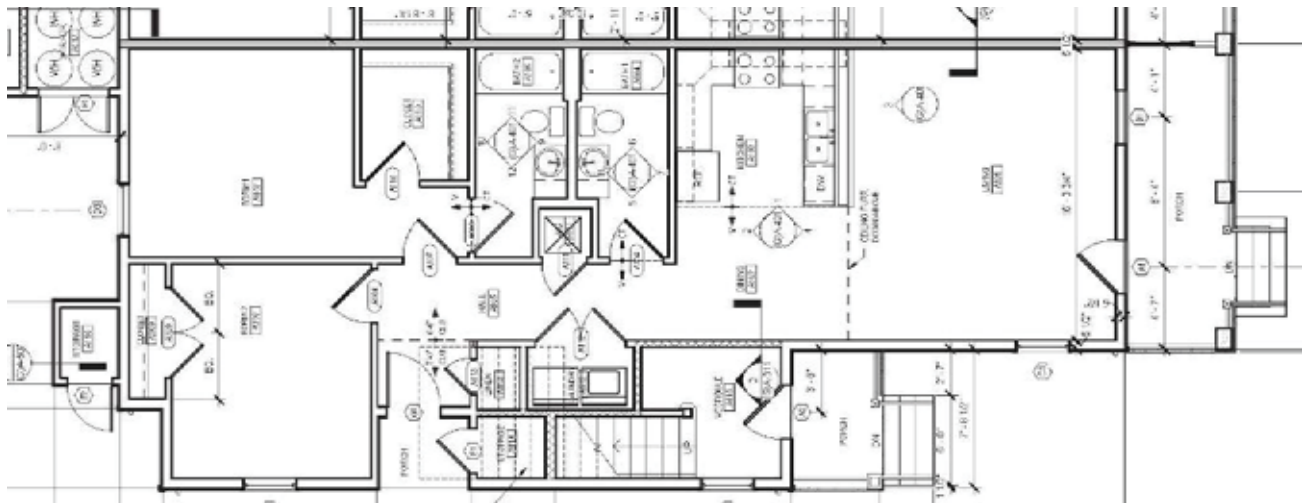

Typical for 13 units.











*Plan for Building Type G / H– first floor two bedroom unit.*





	<b>Inaccessible Unit Features</b>	
--	-----------------------------------	--



<p>49</p>	 <p><i>Primary entry to 2410 Erato. Note trash cans to the left of the door.</i></p> <p><i>Primary entry to 2322 Erato. Note trash cans to the left of the door.</i></p>	<p>The routes to unit trash receptacles are not accessible. There are steps to the front door at every Building Type G and H unit (changes in level, including steps, are not allowed). See Section A of this report. Access to the trash requires either use of the front door or use of a circuitous route that is significantly longer than the routes used by people able to use steps.</p> <p><i>Retrofit:</i>  <i>Trash pads and pick up to be relocated to courtyards. See Accessible Route Diagram.</i></p>
<p>50</p>	 <p><i>1222 - porch exterior door threshold</i></p>	<p>The exterior threshold is 1½ inch high going from living room onto porch at 1222 RJR Way &amp; 2306 Erato. (Maximum 1/4 inch vertical face allowed without bevel.)</p> <p>Thresholds at exterior doors are no higher than ¾ inch. Thresholds and changes in level at these locations are beveled with a slope no greater than 1:2. (Guidelines Requirement 4 (4)).</p> <p><i>Retrofit:</i>  <i>Install a bevel, maximum 1:2 slope to improve access into unit. Note: a ¼” vertical face is acceptable at the threshold. Threshold must be maximum ¾” high, with a maximum ¼” vertical face at threshold, and a 1:2 bevel at the balance.</i></p>

		
51		<p>The interior threshold is 1 inch high going from living room onto porch at unit 1222 RJR Way. (Maximum 1/4 inch vertical face allowed without bevel.)</p> <p>Thresholds at exterior doors are no higher than 3/4 inch. Thresholds and changes in level at these locations are beveled with a slope no greater than 1:2. (Guidelines Requirement 4 (4)).</p> <p><i>Retrofit:</i></p> <p><i>Install a bevel, maximum 1:2 slope to improve access into unit. Note: a 1/4" vertical face is acceptable at the threshold. Threshold must be maximum 3/4" high, with a maximum 1/4" vertical face at threshold, and a 1:2 bevel at the balance.</i></p>
52	 	<p>Exterior storage closet doors are 30 (G) or 27 (H) inches wide with clear opening widths of approximately 28 - 29 inches (minimum 31-5/8 inch required). Closet depth is approximately 40 – 44 inches (maximum 24 inches allowed where door opening is less than 31-5/8 inches).</p> <p>A minimum 32 inches nominal clear opening width (31-5/8 inches) is required for doors intended for user passage. (Guidelines Requirement 3(2)).</p> <p><i>Retrofit:</i></p> <p><i>Exterior storage closets will be re-assigned for Fair Housing covered units. At present, the closets on the rear of the building are assigned to first floor units, and the closets at the entry door are assigned to the upstairs units. These will be reversed, so that the tenants in ground floor units will use storage closets adjacent to their entry doors, which is more convenient. These doors are too narrow as well. Furr out storage closets to limit exterior storage closet depth to 24" so passage door is not required.</i></p>

<p>53</p>	 <p>2410 - Closet door width</p>  <p>2410 - Closet depth</p>  <p>2322 - Closet door width</p>	<p>Interior closet door clear opening widths are 22-1/4 inches (minimum 31-5/8 inch required) for hall linen closet. Closet depth is 29 - 32 inches (maximum 24 inches allowed where door opening is less than 31-5/8 inches).</p> <p>A minimum 32 inches nominal clear opening width (31-5/8 inches) is required for doors intended for user passage. (Guidelines Requirement 3(2)).</p> <p><i>Retrofit:</i>  <i>Furr out back wall of closets to limit depth to 24".</i>  <i>Reinstall fittings.</i></p>
<p>54</p>	 <p>2410 - thermostat height</p>	<p>Thermostat top controls are more than 48-5/8 – 49<sup>3</sup>/<sub>4</sub> inches above the floor (maximum 48 inches allowed).</p> <p>A minimum 15 inches is required and a maximum 48 inches is allowed for the reach range where the space below the control is unobstructed. (Guidelines Requirement 5).</p> <p><i>Retrofit:</i>  <i>Remove thermostat, adjust wiring and re-install thermostats so that the highest operable part is no more than 48" above the floor. Patch prior location. As an alternative, find a replacement thermostat that provides controls lower on the thermostat, so that existing location / wiring may be used.</i></p>

	 <p data-bbox="289 556 609 588"><i>2322 - thermostat height</i></p>	
<p data-bbox="203 611 243 636">55</p>	 <p data-bbox="289 945 654 976"><i>2410 - Kitchen counter area.</i></p>  <p data-bbox="289 1264 678 1333"><i>2410 - Distance from bar wall to outlet by coffee pot.</i></p>  <p data-bbox="289 1621 630 1690"><i>2410 - Distance from back wall to outlet on bar wall.</i></p>	<p data-bbox="703 615 1433 793">No outlets are provided within reach at one kitchen countertop area. Outlets must have a parallel or forward approach provided. For the area in the corner between the range and the sink, both outlets are obstructed by the cabinets and casework (access required).</p> <p data-bbox="703 825 1417 930">Light switches, electrical outlets, thermostats and other environmental controls must be in accessible locations. (Guidelines Requirement 5).</p> <p data-bbox="703 961 1425 1171"><i>Retrofit:</i> To be accessible a corner outlet must be 36" from the corner, so that a wheelchair user can reach the outlet. Either relocate an existing outlet, or install a new outlet in an accessible location. (If space permits, an outlet could be installed on the face of base cabinets.)</p>

<p>56</p>	 <p><i>1222 - Kitchen overview</i></p>  <p><i>1222 – clearance refrigerator to countertop</i></p>  <p><i>2306 – clearance refrigerator to countertop</i></p>	<p>At refrigerator in 1222 RJR Way &amp; 2306 Erato, the clearance at kitchen cabinets is only 52” or 58” of the 60” required in a “U” shaped kitchen.</p> <p>In “U”-shaped kitchens with sink or range or cooktop at the base of the “U”, a 60-inch turning radius is provided to allow parallel approach, or base cabinets are removable at that location to allow knee space for a forward approach. (Guidelines Requirement 7(1)(c)).</p> <p><i>Retrofit:</i>  <i>First try to reposition refrigerator fully against wall. If that is not sufficient, replace existing refrigerator with one that is “counter depth”.</i></p>
<p>57</p>	 <p><i>2410 - Bathtub surround at hall bath.</i></p>	<p>The shape of the bathtub surround precludes the installation of future grab bars with firm attachment to blocking (ability to install grab bars required).</p> <p>Reinforcement is required for the future installation of grab bars and shower seats at toilets, bathtubs and shower compartments. (Guidelines Requirement 6).</p> <p><i>Retrofit:</i>  <i>Obtain a copy of tub surround manufacturer’s product data and specifications including information concerning fiberglass wall thickness and any integral blocking provided during the fabrication of the surround. Investigate with manufacturer to determine if this issue has been solved previously and if so, how. Submit</i></p>



	 <p>2410 - Bathtub surround at master bath.</p> <p>2322 – Tub surround master</p>	<p><i>product data and any proposed retrofit to DOJ for review.</i></p> <p><i>If a compliant retrofit for the installed product is not possible, remove and replace tub surround with one that allows correct future installation of grab bars. In the process, verify blocking installation.</i></p>
<p>58</p>	 <p>2410 - Hall bath toilet 16 1/4"</p> <p>2410 - master toilet 16-7/8"</p> <p>2232 - Hall toilet 15-3/8"</p>	<p>Toilet centerlines are 15-3/8 (2322) to 16-7/8 (2410) inches to the side of the bathtub (minimum 18 inches required).</p> <p>A minimum 18 inches is required between the toilet centerline and the adjacent wall, bathtub or lavatory on the side opposite the direction of approach. (Guidelines Requirement 7 (2)(a)(ii)), Figure 7(a)).</p> <p><i>Retrofit:</i></p> <p><i>Remove toilet, correct plumbing, and re-install toilet 18" minimum from the tub / sidewall. (In some cases, an offset flange, or repositioning on the existing flange may be possible.)</i></p>



	 <p>2232 - master toilet 16 1/4"</p>	
59	Not used.	

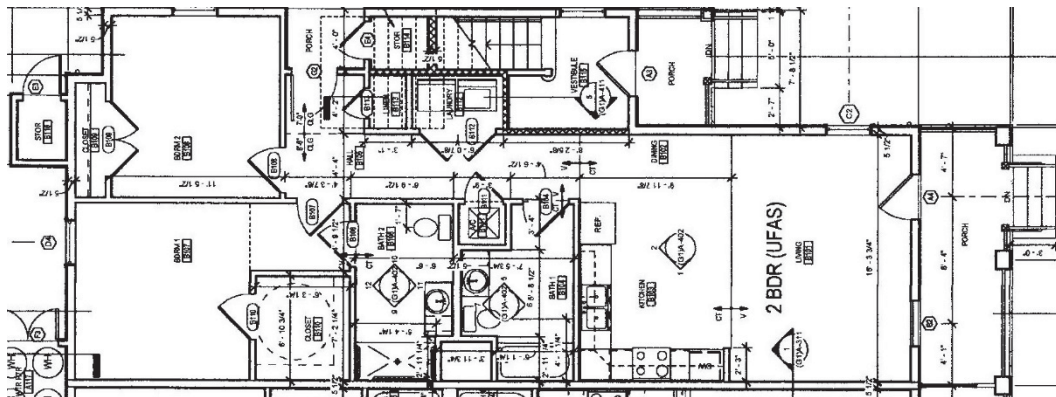

**BUILDING TYPE G-1: 2 Bedroom Unit**

*Typical for 3 units.*









*Plan for Building Type G-1 (UFAS) – first floor two bedroom unit.*

	<p><b>Inaccessible Unit Features</b></p>	
60	 <p><i>Steps to porch at 2308 Erato</i></p>  <p><i>Steps to porch at 1215 RJR</i></p>	<p>The routes to unit trash receptacles are not accessible. There are steps to the front door at every Building Type G-1 (changes in level, including steps, are not allowed). Access to the trash requires either use of the front door or use of a circuitous route that is significantly longer than the routes used by people able to use steps.</p> <p><i>Retrofit:</i>  <i>Trash pads and pick up to be relocated to courtyards.</i>  <i>See Accessible Route Diagram.</i></p>

<p>61</p>	 <p>2308 - porch exterior door threshold</p> <p>1215 - porch exterior door threshold</p>	<p>The exterior threshold is 1¼ inch high going from living room onto porch at 2308 Erato. (Maximum 1/4 inch vertical face allowed without bevel.)</p> <p>Thresholds at exterior doors are no higher than ¾ inch. Thresholds and changes in level at these locations are beveled with a slope no greater than 1:2. (Guidelines Requirement 4 (4)).</p> <p><i>Retrofit:</i></p> <p><i>Install a bevel, maximum 1:2 slope to improve access into unit. Note: a ¼” vertical face is acceptable at the threshold. Threshold must be maximum ¾” high, with a maximum ¼” vertical face at threshold, and a 1:2 bevel at the balance.)</i></p>
<p>62</p>	 <p>2308 – Exterior storage closet</p> <p>2308 - Width of closet door</p>	<p>Exterior storage closet has steps accessing it. Door clear opening width is 29” (minimum 31-5/8” required). Closet depth is approximately 44 inches (maximum 24 inches allowed where door opening is less than 31-5/8”).</p> <p>A minimum 32 inches nominal clear opening width (31-5/8 inches) is required for doors intended for user passage. (Guidelines Requirement 3(2)).</p> <p><i>Retrofit:</i></p> <p><i>Exterior storage closets will be re-assigned for Fair Housing covered units. At present, the closets on the rear of the building are assigned to first floor units, and the closets at the entry door are assigned to the upstairs units. These will be reversed, so that the tenants in ground floor units will use storage closets adjacent to their entry doors, which is more convenient. These doors are too narrow as well. Furr out storage closets to limit exterior storage closet depth to 24”.</i></p>



		
63	<p data-bbox="285 478 646 520"><i>1215 – Width of closet door</i></p>  <p data-bbox="285 827 540 863"><i>2308 - Closet depth</i></p>  <p data-bbox="285 1163 609 1199"><i>2308 - Closet door width</i></p>	<p data-bbox="703 541 1414 684">Interior closet door clear opening widths are 22” (minimum 31-5/8 inch required) for hall linen closet. Closet depth is 29” (maximum 24” allowed where door opening is less than 31-5/8”).</p> <p data-bbox="703 711 1425 821">A minimum 32 inches nominal clear opening width (31-5/8 inches) is required for doors intended for user passage. (Guidelines Requirement 3(2)).</p> <p data-bbox="703 848 813 884"><i>Retrofit:</i></p> <p data-bbox="703 894 1377 963"><i>Furr out back wall of closets to limit depth to 24” so passage door is not required. Reinstall fittings.</i></p>
64	 <p data-bbox="285 1505 659 1575"><i>2308 – Outlet between range and corner</i></p> 	<p data-bbox="703 1220 1406 1436">No outlets are provided within reach at one kitchen countertop area in either 2308 or 1215. Outlets must have a parallel or forward approach provided. For the area in the corner between the range and the sink, both outlets are obstructed by the cabinets and casework (access required).</p> <p data-bbox="703 1463 1411 1572">Light switches, electrical outlets, thermostats and other environmental controls must be in accessible locations. (Guidelines Requirement 5).</p> <p data-bbox="703 1600 813 1635"><i>Retrofit:</i></p> <p data-bbox="703 1646 1425 1814"><i>To be accessible a corner outlet must be 36” from the corner, so that a wheelchair user can reach the outlet. Either relocate an existing outlet, or install a new outlet in an accessible location. (If space permits, an outlet could be installed on the face of base cabinets.)</i></p>

	<p>2308 – Outlet between sink and corner</p>  <p>1215 – Outlet between range and corner</p>  <p>1215 – Outlet between sink and corner</p>	
<p>65</p>	 <p>2308 - thermostat height</p>  <p>1215 – thermostat height</p>	<p>In 2308 Erato, thermostat top controls are more than 48½” above the floor (maximum 48 inches allowed). (Unit 1215 RJR compliant. See photo.)</p> <p>A minimum 15 inches is required and a maximum 48 inches is allowed for the reach range where the space below the control is unobstructed. (Guidelines Requirement 5).</p> <p><i>Retrofit:</i></p> <p><i>Remove thermostat, adjust wiring and re-install thermostats so that the highest operable part is no more than 48” above the floor. Patch prior location. As an alternative, find a replacement thermostat that provides controls lower on the thermostat, so that existing location / wiring may be used.</i></p>

# ATTACHMENT “B”

## **SUPPLEMENTAL INFORMATION**

### SCOPE OF WORK SHEETS



1301 Clearview Pkwy, Metairie LA 70001



Housing Authority of New Orleans

Scope of Work for		Guste III Housing Development			
Work Type		Exterior			
Report No.	Work Item Description	Unit	Quantity	Reference Notes	Page #
1 & 4 (1226 RJR Way)	Removal of Concrete	SY	25.3	Refer to photos and drawings on Sheet- C002	# 4,#6
	Removal of Guardrails	LF	15	Refer to photos and drawings on Sheet- C002	# 4,#6
1 & 4 (1226 RJR Way)	Install new ramp as indicated on the drawings	SY	12.6	Refer to photos and drawings on Sheet- C002A	# 4,#6
	Install new concrete sidewalk as indicated on the drawings	SY	26.3	Refer to photos and drawings on Sheet- C002A	# 4,#6
	Install New Guardrail ,shape and size to match existing guardrails	LF	12	Refer to photos and drawings on Sheet- C002A	# 4,#6
	Install New Guardrail with handrail,shape and size to match existing guardrails	LF	50	Refer to photos and drawings on Sheet- C002A	# 4,#6
	Install new Concrete sidewalk (Trash pad)	SY	1	Refer to photos and drawings on Sheet- C002A	# 4,#6
	Sodding	SY	9.45	Refer to photos and drawings on Sheet- C002A	# 4,#6
	Required Regrading of ground as shown on plans	SY	8.95	Refer to photos and drawings on Sheet- C002A	# 4,#6
1 & 4 (1217 S LIBERTY ST)	Removal of concrete	SY	12.5	Refer to photos and drawings on Sheet- C003	# 4,#6
	Removal of Guardrails	LF	17	Refer to photos and drawings on Sheet- C003	# 4,#6
1 & 4 (1217 S LIBERTY ST)	Install new ramp as indicated on the drawings	SY	14.1	Refer to photos and drawings on Sheet- C003A	# 4,#6
	Install new concrete sidewalk as indicated on the drawings	SY	20.7	Refer to photos and drawings on Sheet- C003A	# 4,#6
	Install New Guardrail with Handrail ,shape and size to match existing guardrails	LF	67.5	Refer to photos and drawings on Sheet- C003A	# 4,#6
	Install New Guardrail ,shape and size to match existing guardrails	LF	13	Refer to photos and drawings on Sheet- C003A	# 4,#6
1 & 4 (2414 ERATO ST)	Removal of Concrete	SY	9	Refer to photos and drawings on Sheet- C004	# 4,#6
	Removal of Guardrails	LF	9.5	Refer to photos and drawings on Sheet- C004	# 4,#6
1 & 4 (2414 ERATO ST)	Install new ramp as indicated on the drawings	SY	13	Refer to photos and drawings on Sheet- C004A	# 4,#6
	Install sidewalk as indicated on the drawings	SY	15.1	Refer to photos and drawings on Sheet- C004A	# 4,#6
	Install New Guardrail with Handrail ,shape and size to match existing guardrails	LF	59	Refer to photos and drawings on Sheet- C004A	# 4,#6
	Install New Guardrail ,shape and size to match existing guardrails	LF	6	Refer to photos and drawings on Sheet- C004A	# 4,#6
1 & 4 (2320 ERATO)	Removal of Concrete	SY	12	Refer to photos and drawings on Sheet- C005	# 4,#6

	Removal of Guardrails	LF	11.5	Refer to photos and drawings on Sheet- C005	# 4,#6
1 & 4 (2320 ERATO)	Install new ramp as indicated on the drawings	SY	13	Refer to photos and drawings on Sheet- C005A	# 4,#6
	Instal sidewalk as indicated on the drawings	SY	28	Refer to photos and drawings on Sheet- C005A	# 4,#6
	Install New Guardrail with Handrails ,shape and size to match existing guardrails	LF	61.5	Refer to photos and drawings on Sheet- C005A	# 4,#6
	Install New Guardrail ,shape and size to match existing guardrails	LF	8	Refer to photos and drawings on Sheet- C005A	# 4,#6
	Install new Concrete trash pad	SY	1	Refer to photos and drawings on Sheet- C005A	
1 & 4 (1208 RJR Way)	Removal of Concrete	SY	2.7	Refer to photos and drawings on Sheet- C006	# 4,#6
	Removal of Guardrails	LF	14	Refer to photos and drawings on Sheet- C006	# 4,#6
1 & 4 (1208 RJR Way)	Install new ramp as indicated on the drawings	SY	13	Refer to photos and drawings on Sheet- C006A	# 4,#6
	Install sidewalk as indicated on the drawings	SY	20	Refer to photos and drawings on Sheet- C006A	# 4,#6
	Install New Guardrail with Handrail ,shape and size to match existing guardrails	LF	65.5	Refer to photos and drawings on Sheet- C006A	# 4,#6
	Install New Guardrail,shape and size to match existing guardrails	LF	10	Refer to photos and drawings on Sheet- C006A	# 4,#6
	Install new Concrete trash pad	SY	1	Refer to photos and drawings on Sheet- C006A	
2	Remove and replace cocnrete panels in parking area as shown on plans	SY	80	Refer to photos and drawings on Sheet- C007	# 4,#6
	Remove and install new accessible aisle striping as shown on plan.Also require yellow striping for reassigned Non-ADA parking spots.	LF	183	Refer to photos and drawings on Sheet- C007	# 4,#6
	Required Adjustment of Manhole	EA	1	Refer to photos and drawings on Sheet- C007	# 4,#6
3	New cocnrete sidewalk to be installed as described on plans	SY	1.5	Refer to drawings on Sheet- C007	# 4,#6
5 abcde	Remove and replace existing sidewalk as indicated on plans.	SY	12	Refer to drawings on Sheet- C008	#7
5 lmnop	Remove e existing sidewalk as indicated on the plans.	SY	29.7	Refer to drawings on Sheet- C008	#7
	New cocnrete sidewalk to be installed as described on plans	SY	27	Refer to drawings on Sheet- C008	#7
	Install new CNO curb ramp type 13	SY	2.7	Refer to drawings on Sheet- C008	#7
5 qr	Remove and replace existing sidewalk as indicated on the plans	SY	4.5	Refer to drawings on Sheet- C008	#7
5 s	Remove and replace existing curb ramp with CNO Type 5 curb ramp	SY	13	Refer to drawings on Sheet- C009	#7
5 t	Remove existing sidewalk as indicated on the plans	SY	33.6	Refer to drawings on Sheet- C009	#7
	Install New Concrete sidewalk as indicated on plans	SY	33.6	Refer to drawings on Sheet- C009	#7
5 z	Remove concrete panels as indicated on the plans	SY	1	Refer to drawings on Sheet- C009	#8
	Install concrete panels as indicated on the plans	SY	3	Refer to drawings on Sheet- C009	#8
5 Y & AA	Remove concrete sidewalk as indicated on the plans	SY	54	Refer to drawings on Sheet- C010	#8
	Install concrete sidewalk as indicated on the plans	SY	51.3	Refer to drawings on Sheet- C010	#8
	Install CNO Type 13 curb ramp	SY	2.7	Refer to drawings on Sheet- C010	#8
2310 ERATO ST	Remove Conc sidewalk as indicated on plans	SY	20	Refer to photos and drawings on Sheet- C010	# 4,#6
2310 ERATO ST	Remove and Replace Conc sidewalk as indicated on plans	SY	20	Refer to photos and drawings on Sheet- C010A	# 4,#6
	Install Handrails as indicated on plans	LF	32	Refer to photos and drawings on Sheet- C010A	# 4,#6

	Install New Conc Trash Pad	SY	1	Refer to photos and drawings on Sheet- C010	
5 DD	Remove existing Curb ramp and replace with CNO Type 5 ramp.	SY	16.5	Refer to drawings on Sheet- C009	#8
5 OO	Remove and replace concrete sidewalk as indicated on the plans.New sidewalk running slope to be under 5 percent slope max and cross slope to be under 2 percent slope max.	SY	26.5	Refer to drawing and photo on Sheet- C011	#8
	Install new Concrete trash pad	SY	1	Refer to drawing and photo on Sheet- C011	
6 efghi	Remove and replace east and west sidewalk at as indicated on plans at driveway near 1202-1204 Freret St.Remove and replace driveway as indicated on the plans.Provide detectable warning surfaces at curb ramps	SY	12	Refer to drawing and photo on Sheet- C014	#9
	Remove and replace driveway as indicated on the plans	SY	47	Refer to drawing and photo on Sheet- C014	#9
7	Remove and replace existing concrete panel as indicated on the plans.	SY	5.5	Refer to drawing and photo on Sheet- C015	#11
9b	Remove existing structures and obstructions as indicated on the plans	LS	1	Refer to drawing and photo on Sheet- C016	#11
	Remove existing sidewalk as indicated on the plans	SY	18.6	Refer to drawing and photo on Sheet- C016	#11
	Install new Ramp as indicated on the plans	SY	7.5	Refer to drawing and photo on Sheet- C016	#11
	Install new concrete sidewalk as indicated on the plans	SY	16.5	Refer to drawing and photo on Sheet- C016	#11
	Required New handrails. Shape and size to match existing	LF	29	Refer to drawing and photo on Sheet- C016	#11
	Install New Concrete trash pad	SY	1	Refer to drawing and photo on Sheet- C016	
9c	Remove existing structures and obstruction as indicated on the plans	LS	1	Refer to drawings and photos on Sheet- C017	#11
	Remove existing concrete sidewalk as indicated on the plans	SY	1	Refer to drawings and photos on Sheet- C017	#11
	Install new ramp as indicated on the plans	SY	3	Refer to drawings and photos on Sheet- C017	#11
	Install New concrete sidewalk as indicated on the plans	SY	0.2	Refer to drawings and photos on Sheet- C017	#11
	Required New handrails as shown on plans. Shape and size to match existing.	LF	13.5	Refer to drawings and photos on Sheet- C017	#11
	Install New Concrete trash pad	SY	1	Refer to drawings and photos on Sheet- C017	
9d	Remove existing structures and obstructions as indicated on the plans	LS	1	Refer to drawings and photos on Sheet- C017	#11
	Remove existing concrete sidewalk as indicated on the plans	SY	4.6	Refer to drawings and photos on Sheet- C017	#11
	Install new ramp as indicated on the plans	SY	5	Refer to drawings and photos on Sheet- C017	#11
	Install New concrete sidewalk as indicated on the plans	SY	3	Refer to drawings and photos on Sheet- C017	#11
	Required New handrails. Shape and size to match existing	LF	24.1	Refer to drawings and photos on Sheet- C017	#11
	Install New Concrete trash pad	SY	1	Refer to drawings and photos on Sheet- C017	
9 e	Remove existing concrete ramp and sidewalk as indicated on the plans	SY	10	Refer to drawing and photo on Sheet- C018	#11
	Removal of Guardrails	LF	9	Refer to drawing and photo on Sheet- C018	#11

9 e	Remove existing concrete ramp and sidewalk as indicated on the plans	SY	10	Refer to drawing and photo on Sheet-C018	#11
	New handrail. Shape and size to match existing	LF	90	Refer to drawing and photo on Sheet-C018	#11
	Handrail removal	LF	37	Refer to drawing and photo on Sheet-C018	#11
	Install new Conc Ramp	SY	12	Refer to drawing and photo on Sheet-C018	#11
	Install new Concrete for sidewalk as indicated in plans	SY	6	Refer to drawing and photo on Sheet-C018	#11
	Install New Concrete trash pad	SY	1	Refer to drawing and photo on Sheet-C018	
9f	Remove and replace concrete sidewalk as indicated on the plans	SY	10	Refer to drawings on Sheet- C019	#11
	Install New Concrete trash pad	SY	1	Refer to drawings on Sheet- C019	
10 b	Grinding of existng concrete surface as indicated on plans	SY	18.1	Refer to drawings and photo on Sheet-C019	#12
	Install New Concrete trash pad	SY	1	Refer to drawings and photo on Sheet-C019	
14/11	Add additional concrete panel as indicated on the drawing	SY	2.5	Refer to drawings and photo on Sheet-C020	#13,#14
12 b	Install new hand rails	LF	12	Refer to drawings on Sheet- C020 and C-025	#13
	Install new ramp	SY	2.5	Refer to drawings on Sheet- C020 and C-025	#13
	Remove and replace existing concrete sidewalk and panel as indicated on the plans	SY	40.5	Refer to drawings on Sheet- C020 and C-025	#13
12 c	Remove and replace existing concrete sidewalk and panel as indicated on the plans	SY	4.5	Refer to drawing and photo on Sheet- C-021	#13
2408 ERATO	Remove existing structures and obstructions as indicated on the plans	LS	1	Refer to drawings and photos on Sheet-C-022	# 4,#6
	Remove existing concrete ramp and sidewalk as indicated on the plans	SY	2.8	Refer to drawings and photos on Sheet-C-022	# 4,#6
	Install New Concrete ramp	SY	6.4	Refer to drawings and photos on Sheet-C-022	# 4,#6
	Install new concrete sidewalk as indicated in drawings.	SY	2.2	Refer to drawings and photos on Sheet-C-022	# 4,#6
	Required New handrails. Shape and size to match existing	LF	32	Refer to drawings and photos on Sheet-C-022	# 4,#6
	Install New Concrete trash pad	SY	1	Refer to drawings and photos on Sheet-C-022	
2414 ERATO	Remove existing structures and obstructions as indicated on the plans	LS	1	Refer to drawings and photos on Sheet-C-022	# 4,#6
	Remove existing concrete sidewalk as indicated on the plans	SY	12	Refer to drawings and photos on Sheet-C-022	# 4,#6
	Install new concrete ramp as indicated in drawings.	SY	12.3	Refer to drawings and photos on Sheet-C-022	# 4,#6
	Install new concrete sidewalk	SY	9.5	Refer to drawings and photos on Sheet-C-022	# 4,#6
	Install New Concrete trash pad	SY	1	Refer to drawings and photos on Sheet-C-022	
	Required New handrails. Shape and size to match existing	LF	52	Refer to drawings and photos on Sheet-C-022	# 4,#6
16	Porch area in front of the main door of the units to be redone as shown on the plans.	SY	136	Refer to drawings on Sheet- C-023, For addresses of the units where this work needs to be performed see NOTE on Sheet-C023.	#15
1213 S LIBERTY ST	Remove and Replace Conc sidewalk as indicated on plans	SY	32.5	Refer to photos and drawings on Sheet- C026	# 4,#6
	Install new concrete sidewalk as indicated on plans	SY	32.5	Refer to photos and drawings on Sheet- C026	# 4,#6
	New Concrete trash pad as indicated on plans	SY	1	Refer to photos and drawings on Sheet- C026	# 4,#6
2400 MAIL CENTRE	Remove existing concrete sidewalk as indicated on the plans	SY	31.5	Refer to drawings on Sheet- C-026	

	Install new concrete ramp as indicated in drawings.	SY	33.5	Refer to drawings on Sheet- C-026	
2210 CLIO ST	Remove existing concrete sidewalk as indicated on the plans	SY	19.6	Refer to drawings on Sheet- C-027	
	Install new concrete ramp as indicated in drawings.	SY	19.6	Refer to drawings on Sheet- C-027	
1220 RJR WAY	Install new Concrete trash pad	SY	1	Refer to photos and drawings on Sheet- C027	



# SCOPE OF WORK SHEETS

M Building  
Common Areas



# SCOPE OF WORK SHEETS

M Building  
First Floor Units





1301 Clearview Pkwy, Metairie LA 70001



Housing Authority of New Orleans

Scope of Work for		Guste III Housing Development			
"M" Bldg - Unit Type "A"		Interior - <b>Unit #103</b> - 1st Floor			
#	Work Item Description	Unit	Quantity	Reference Notes	Rpt #
INT 03	Relocate Light Switch /Thermostat to be no more than 48" AFF to operating devices. Patch, finish and paint entire wall to match existing.	Ea	1	Relocate thermostat to 48" to operating buttons per sht G-003.	# 25
INT 07	Remove existing tub & tub surround at both baths. Install blocking in wall for future grab bars. Install new tub & surround as detailed.	LS	2	Refer to Product Data Note #7 for type of tub/tub surround.	# 26
INT 09	Remove existing balcony door. Install new door as described and detailed in drawings.	LS	1	Refer to details 4, 5 & C on sheet A-141 for balcony door details.	# 24



1301 Clearview Pkwy, Metairie LA 70001



Housing Authority of New Orleans

Scope of Work for		Guste III Housing Development			
"M" Bldg - Unit Type "A"		Interior - <b>Unit #104</b> - 1st Floor			
#	Work Item Description	Unit	Quantity	Reference Notes	Rpt #
INT 03	Relocate Light Switch /Thermostat to be no more than 48" AFF to operating devices. Patch, finish and paint entire wall to match existing.	Ea	1	Relocate thermostat to 48" to operating buttons per sht G-003.	# 25
INT 04	Where indicated at existing entry/balcony doors, provide thresholds as indicated in the product data notes.	Ea	1	Refer to Product Data Notes #2 & #3 for type of threshold.	# 32
INT 07	Remove existing tub & tub surround at both baths. Install blocking in wall for future grab bars. Install new tub & surround as detailed.	LS	2	Refer to Product Data Note #7 for type of tub/tub surround.	# 26
INT 09	Remove existing balcony door. Install new door as described and detailed in drawings.	LS	1	Refer to details 4, 5 & C on sheet A-141 for balcony door details.	# 24













1301 Clearview Pkwy, Metairie LA 70001



Housing Authority of New Orleans

Scope of Work for		Guste III Housing Development			
"M" Bldg - Unit Type "A"		Interior - <b>Unit #109</b> - 1st Floor			
#	Work Item Description	Unit	Quantity	Reference Notes	Rpt #
INT 04	Where indicated at existing entry/balcony doors, provide thresholds as indicated in the product data notes.	Ea	1	Refer to Product Data Notes #2 & #3 for type of threshold.	# 32
INT 07	Remove existing tub & tub surround at both baths. Install blocking in wall for future grab bars. Install new tub & surround as detailed.	LS	2	Refer to Product Data Note #7 for type of tub/tub surround.	# 26
INT 09	Remove existing balcony door. Install new door as described and detailed in drawings.	LS	1	Refer to details 4, 5 & C on sheet A-141 for balcony door details.	# 24



1301 Clearview Pkwy, Metairie LA 70001



Housing Authority of New Orleans

Scope of Work for		Guste III Housing Development			
"M" Bldg - Unit Type "A"		Interior - <b>Unit #110</b> - 1st Floor			
#	Work Item Description	Unit	Quantity	Reference Notes	Rpt #
INT 03	Relocate Light Switch /Thermostat to be no more than 48" AFF to operating devices. Patch, finish and paint entire wall to match existing.	Ea	1	Relocate thermostat to 48" to operating buttons per sht G-003.	# 25
INT 04	Where indicated at existing entry/balcony doors, provide thresholds as indicated in the product data notes.	Ea	1	Refer to Product Data Notes #2 & #3 for type of threshold.	# 32
INT 07	Remove existing tub & tub surround at both baths. Install blocking in wall for future grab bars. Install new tub & surround as detailed.	LS	2	Refer to Product Data Note #7 for type of tub/tub surround.	# 26
INT 09	Remove existing balcony door. Install new door as described and detailed in drawings.	LS	1	Refer to details 4, 5 & C on sheet A-141 for balcony door details.	# 24







1301 Clearview Pkwy, Metairie LA 70001



Housing Authority of New Orleans

Scope of Work for		Guste III Housing Development			
"M" Bldg - Unit Type "B"		Interior - <b>Unit #113</b> - 1st Floor			
#	Work Item Description	Unit	Quantity	Reference Notes	Rpt #
INT 01	Remove existing outlet next to range at both sides. Install blank plate. Relocate outlet w/extended box. Place per code.	Ea	2	See Photos 4, 5 & 8 on sheet A-143. Outlets to be 36" from corner.	# 55
INT 03	Relocate Light Switch /Thermostat to be no more than 48" AFF to operating devices. Patch, finish and paint entire wall to match existing.	Ea	1	Relocate thermostat to 48" to operating buttons per sht G-003.	# 31
INT 04	Where indicated at existing entry/balcony doors, provide thresholds as indicated in the product data notes.	Ea	2	Refer to Product Data Note #3 for type of threshold.	# 32
INT 08	Remove Toilet. Provide offset flange or reroute piping to move toilet to be 18" from centerline of toilet. Patch ceramic floor tile as required.	Ea	1	Entry Toilet at 19-1/2".	# 27
INT 12	Remove existing kitchen sink. Replace with new sink to match existing shape and size with drain at rear for knee space.	LS		Reroute piping for knee access. Provide slanted panel per Detail #1 on sheet A-141.	# 31b
INT 14	Remove existing grab bars. Install new grab bars meeting code.	EA		See sheet G-003 for grab bar spacing.	# 31d

# SCOPE OF WORK SHEETS

M Building  
Second Floor Units































# SCOPE OF WORK SHEETS

M Building  
Third Floor Units





1301 Clearview Pkwy, Metairie LA 70001



Scope of Work for		Guste III Housing Development			
"M" Bldg - Unit Type "J"		Interior - <b>Unit #302</b> - 3rd Floor			
#	Work Item Description	Unit	Quantity	Reference Notes	Rpt #
INT 01	Remove existing outlet next to range at both sides. Install blank plate. Relocate outlet w/extended box. Place per code.	Ea	2	See Photos 4, 5 & 8 on sheet A-143. Outlets to be 36" from corner.	# 55
INT 03	Relocate Light Switch /Thermostat to be no more than 48" AFF to operating devices. Patch, finish and paint entire wall to match existing.	Ea	1	Relocate thermostat to 48" to operating buttons per sht G-003.	# 41
INT 04	Where indicated at existing entry/balcony doors, provide thresholds as indicated in the product data notes.	Ea	1	Refer to Product Data Notes #2 & #3 for type of threshold.	# 32
INT 07	Remove existing tub & tub surround at both baths. Install blocking in wall for future grab bars. Install new tub & surround as detailed.	LS	2	Refer to Product Data Note #7 for type of tub/tub surround.	# 46
INT 10	Remove Lav and Vanity Cabinet. Provide new lav, faucet & vanity to locate center of lav to be no less than 15" from sidewall. Replace cultured marble	LS	1	Refer to Product Data Note #6 for type of items to provide.	# 47







1301 Clearview Pkwy, Metairie LA 70001



Housing Authority of New Orleans

Scope of Work for		Guste III Housing Development			
"M" Bldg - Unit Type "A"		Interior - <b>Unit #304</b> - 3rd Floor			
#	Work Item Description	Unit	Quantity	Reference Notes	Rpt #
INT 03	Relocate Light Switch /Thermostat to be no more than 48" AFF to operating devices. Patch, finish and paint entire wall to match existing.	Ea	1	Relocate thermostat to 48" to operating buttons per sht G-003.	# 25
INT 04	Where indicated at existing entry/balcony doors, provide thresholds as indicated in the product data notes.	Ea	1	Refer to Product Data Notes #2 & #3 for type of threshold.	# 32
INT 07	Remove existing tub & tub surround at both baths. Install blocking in wall for future grab bars. Install new tub & surround as detailed.	LS	2	Refer to Product Data Note #7 for type of tub/tub surround.	# 26
INT 08	Remove Toilet. Provide offset flange or reroute piping to move toilet to be 18" from centerline of toilet. Patch ceramic floor tile as required.	Ea	2	Entry Toilet at 19". Bath Toilet at 20".	# 27
INT 09	Remove existing balcony door. Install new door as described and detailed in drawings.	LS	1	Refer to details 4, 5 & C on sheet A-141 for balcony door details.	# 24











1301 Clearview Pkwy, Metairie LA 70001



*Housing Authority of New Orleans*

Scope of Work for		Guste III Housing Development			
"M" Bldg - Unit Type "A"		Interior - <b>Unit #309</b> - 3rd Floor			
#	Work Item Description	Unit	Quantity	Reference Notes	Rpt #
INT 04	Where indicated at existing entry/balcony doors, provide thresholds as indicated in the product data notes.	Ea	1	Refer to Product Data Notes #2 & #3 for type of threshold.	# 32
INT 07	Remove existing tub & tub surround at both baths. Install blocking in wall for future grab bars. Install new tub & surround as detailed.	LS	2	Refer to Product Data Note #7 for type of tub/tub surround.	# 26
INT 08	Remove Toilet. Provide offset flange or reroute piping to move toilet to be 18" from centerline of toilet. Patch ceramic floor tile as required.	Ea	1	Entry Toilet at 15"	# 27
INT 09	Remove existing balcony door. Install new door as described and detailed in drawings.	LS	1	Refer to details 4, 5 & C on sheet A-141 for balcony door details.	# 24











# SCOPE OF WORK SHEETS

M Building  
Fourth Floor Units

























1301 Clearview Pkwy, Metairie LA 70001



Housing Authority of New Orleans

Scope of Work for		Guste III Housing Development			
"M" Bldg - Unit Type "B"		Interior - <b>Unit #413</b> - 4th Floor			
#	Work Item Description	Unit	Quantity	Reference Notes	Rpt #
INT 01	Remove existing outlet next to range at both sides. Install blank plate. Relocate outlet w/extended box. Place per code.	Ea	2	See Photos 4, 5 & 8 on sheet A-142. Outlets to be 36" from corner.	# 55
INT 03	Relocate Light Switch /Thermostat to be no more than 48" AFF to operating devices. Patch, finish and paint entire wall to match existing.	Ea	1	Relocate thermostat to 48" to operating buttons per sht G-003.	# 31
INT 11	Lower elec panelboard to make top most operable is at 48" AFF.	LS	1	See Report #31a.	# 31a
INT 13	Remove braces under Lav Counter. Modify brace at wall for knee clearance. Reinstall open end brace to be 30" clear.	LS	1		# 31c
INT 15	Remove to reinstall toilet tissue holder. Per code. Patch wall and paint.	EA	1	See sheet G-003 for toilet tissue requirements.	# 31e & f
INT 16	Remove to reinstall shower controls and piping to meet code. Patch existing tub surround as req'd.	EA	1	See Report #31g for direction.	# 31g

# ATTACHMENT “C”

## **SUPPLEMENTAL INFORMATION**

FIBERGLASS DOOR SPEC  
(from Original Project)



## SECTION 081613 – FIBERGLASS DOORS

### PART 1 - GENERAL

#### 1.1 RELATED DOCUMENTS

- A. Drawings and general provisions of the Contract, including General and Supplementary Conditions and Division 01 Specification Sections, apply to this Section.

#### 1.2 SUMMARY

- A. Section includes fiberglass entrance doors and glazed fiberglass doors used as full length windows.
- B. Related Requirements:
  - 1. Division 08 Section "Stile and Rail Wood Doors for paneled interior wood doors.
  - 2. Division 08 Section "Hollow Metal Doors and Frames" for packaged, hollow metal door and frame assemblies.
  - 3. Division 08 Section "**Door Hardware**" for door hardware for doors not supplied by the door manufacturer.

#### 1.3 REFERENCES

- A. American Architectural Manufacturer Association (AAMA)
  - 1. AAMA 1304; Voluntary Specification for Forced Entry Resistance of Side-Hinged Door Systems.
- B. ASTM International
  - 1. ASTM E283; Standard Test Method for Determining Rate of Air Leakage Through Exterior Windows, Curtain Walls, and Doors Under Specified Pressure Differences Across the Specimen
  - 2. ASTM E330; Standard Test Method for Structural Performance of Exterior Windows, Doors, Skylights and Curtain Walls by Uniform Static Pressure Difference
  - 3. ASTM E331; Standard Test Method for Water Penetration of Exterior Windows, Skylights, Doors, and Curtain Walls by Uniform Static Air Pressure Difference
  - 4. ASTM E547; Standard Test Method for Water Penetration of Exterior Windows, Skylights, Doors, and Curtain Walls by Cyclic Static Air Pressure Difference
  - 5. ASTM E 1886; Standard Test Method for Performance of Exterior Windows, Curtain Walls, Doors, and Impact Protective Systems Impacted by Missile(s) and Exposed to Cyclic Pressure Differentials
  - 6. ASTM E 1996; Standard Specification for Performance of Exterior Windows, Curtain Walls, Doors and Impact Protective Systems Impacted by Windborne Debris in Hurricanes
- C. National Fenestration Rating Council (NFRC)

1. NFRC 100; Procedure for Determining Fenestration Thermal Properties
2. NFRC 200; Solar Heat Gain Coefficient and Visible Transmittance

D. Florida Building Code

1. FBC Section 1626: High Velocity Hurricane Zones – Impact Tests for Windborne Debris

1.4 DESIGN REQUIREMENTS

A. Structural Performance, Exterior Doors: Exterior doors shall withstand the wind loads, the effects of gravity loads, and loads and stresses within limits and under conditions indicated according to **SEI/ASCE 7**.

1. Wind Loads: **As indicated on structural Drawings.**

- a. Basic Wind Speed: As indicated in Structural Drawings with a minimum **130 mph (57 m/s)**.
- b. Importance Factor: As indicated in Structural Drawings.
- c. Exposure Category: As indicated in Structural Drawings.

2. Deflection Limits: Design doors to withstand design wind load without evidencing permanent deformation or disengagement of door components.

B. Windborne-Debris-Impact-Resistance Performance: Provide **impact-protective** overhead coiling doors that pass missile-impact and cyclic-pressure tests when tested according to **ASTM E 1886 and ASTM E 1996**.

1. Large Missile Test: For doors located within 30 feet (9.144 m) of grade.

C. NFRC Requirements – Provide doors capable of complying with the following total door ratings:

1. U-Factor: 0.32 in accordance with NFRC 100.
2. Solar Heat Gain Coefficient (SHGC): 0.29 in accordance with NFRC 200.

1.5 COORDINATION

A. Coordinate anchorage installation for hollow-metal frames. Furnish setting drawings, templates, and directions for installing anchorages, including sleeves, concrete inserts, anchor bolts, and items with integral anchors. Deliver such items to Project site in time for installation.

1.6 PREINSTALLATION MEETINGS

A. Preinstallation Conference: Conduct conference at Project site.

1.7 ACTION SUBMITTALS

A. Product Data: Manufacturer's current data for each type of product.

1. Include construction details, material descriptions, core descriptions, door frame construction, installation details, and finishes.

- B. Shop Drawings: Include the following:
  - 1. Elevations of each door type.
  - 2. Details of doors, including vertical- and horizontal-edge details and fiberglass thicknesses.
  - 3. Frame details for each frame type, including dimensioned profiles and metal thicknesses.
  - 4. Locations of reinforcement and preparations for hardware.
  - 5. Details of each different wall opening condition.
  - 6. Details of anchorages, joints, field splices, and connections.
  - 7. Details of accessories.
  - 8. Details of moldings, removable stops, and glazing.
  - 9. Details of conduit and preparations for power, signal, and control systems.
- C. Samples for Initial Selection: For units with factory-applied color finishes.
- D. Samples for Verification:
  - 1. For each type of exposed finish required, prepared on Samples of not less than 3 by 5 inches (75 by 127 mm).
- E. Schedule: Provide a schedule of fiberglass door work prepared by or under the supervision of supplier, using same reference numbers for details and openings as those on Drawings. Coordinate with final Door Hardware Schedule.

#### 1.8 INFORMATIONAL SUBMITTALS

- A. Product Test Reports: For each type of hollow-metal door and frame assembly, for tests performed by a qualified testing agency.
- B. Manufacturer's Instructions: Provide manufacturer's written installation instructions.

#### 1.9 DELIVERY, STORAGE, AND HANDLING

- A. Deliver doors, materials and components in manufacturer's original, unopened, undamaged containers with identification labels intact. Do not use nonvented plastic.
  - 1. Provide additional protection to prevent damage to factory-finished units.
- B. Deliver welded frames with two removable spreader bars across bottom of frames, tack welded to jambs and mullions.
- C. Store doors vertically under cover at Project site with head up as recommended by the Manufacturer.

#### 1.10 WARRANTY

- A. Manufacturer standard warranty indicating that doors will be free from material and workmanship defects from the date of substantial completion for the time periods indicated below:
  - 1. Door System: 25 Years.

2. Metal clad pressure-treated wood door frames: Lifetime.

## PART 2 - PRODUCTS

### 2.1 MANUFACTURERS

- A. Source Limitations: Obtain hollow-metal work from single source from single manufacturer.

### 2.2 REGULATORY REQUIREMENTS

#### A. Exterior Fiberglass Doors:

1. Basis-of-Design Product: Subject to compliance with requirements, provide JeldWen Architectural Fiberglass Doors or comparable product by one of the following:
  - a. Therma-Tru.
  - b. Stanley
  - c. Beveled Glass Designs
  - d. Hayfield Windows and Doors.
  - e. Jeld Wen
  - f. Kaylien Doors
  - g. Kolbe & Kolbe Millwork
  - h. Masonite Intl. Corp
  - i. Peachtree Doors and Windows
  - j. Pella Corporation
  - k. Plastpro
  - l. Target Windows & Doors
  - m. Taylor Building Products
  - n. Trinity Glass International
2. Provide door types matching those indicated in the drawings.

### 2.3 MATERIALS

- A. Fiberglass Skins: Long Fiber Injection (LFI) Technology, incorporating multiple layers of resins, tinted resins, base colors and reinforcing materials.
- B. Stiles and Rails: Engineered wood (laminated veneer lumber).
- C. Core: Polyurethane core.

### 2.4 FIBERGLASS ENTRANCE AND EXTERIOR DOORS

- A. Thickness: 1-3/4 inch.
- B. Door Style: Solid or Full-Light Glazed with Mullion Grids as indicated in Door Schedule and Drawings.
- C. Door Shape: Squared Top.
  1. Panels per Face on Entry Doors: Six..

2. Mullion Pattern: As indicated in Drawings with interior, exterior, and spacer grids as selected by Architect from manufacturer's full range of styles.

D. Finish

1. Paint Surface
  - a. Color: As selected by Architect from Manufacturer's full range.

E. Hardware

1. Entry Locksets: "Handed" as required per drawings.
  - a. Exterior escutcheon plate
  - b. Mortise lock
  - c. Interior escutcheon plate
  - d. Interior operator: Lever
2. Glazed Doors: Manufacturer's standard three-point locking system with lever handles.
3. Finish: Antique Nickel or Satin Nickel as selected by the Architect from Manufacturer's full range.

2.5 PREHUNG HARDWOOD SYSTEMS

- A. Profile: Single Doors.
- B. Jamb: Aluminum Clad solid pressure treated wood.
  1. Width: As indicated in Drawings.
  2. Profile: Rabbeted.
  3. Wood: "Auralast" or equivalent.
  4. Aluminum cladding finish to match door finish and to meet
- C. Casing: Brickmold unless indicated otherwise in Drawings.
- D. Hinges: Manufacturer's standard Solid brass concealed-bearing.
  1. Size: 4 by 4 square.
  2. Finish: Satin Nickel.
- E. Sills: Aluminum with Polished Aluminum Finish.

2.6 GLAZING

- A. Insulating-Glass Units: Factory-assembled units consisting of sealed lites of glass separated by a dehydrated interspace, qualified according to ASTM E 2190, and complying with other requirements specified.
  1. Sealing System: Dual seal, with **manufacturer's standard** primary and secondary.
  2. Spacer: **Manufacturer's standard spacer material and construction.**

- B. Glass Type: Low-e-coated, clear insulating laminated glass.
  - 1. Overall Unit Thickness: nominal 3/4 inch (19 mm).
  - 2. Thickness of Outdoor Lite: **3.0 mm.**
  - 3. Outdoor Lite: **Fully tempered float glass.**
  - 4. Interspace Content: Manufacturer's standard.
  - 5. Indoor Lite: Clear laminated glass with two plies of **heat-strengthened float glass** or **fully tempered float glass.**
    - a. Thickness of Each Glass Ply: **3.0 mm.**
    - b. Interlayer Thickness: Provide thickness not less than that tested in the manufacturer's assembly and as needed to comply with the requirements.
    - c. Provide safety glazing labeling.
    - d. Construction: Laminate glass with one of the following to comply with interlayer manufacturer's written recommendations:
      - 1) Polyvinyl butyral interlayer.
      - 2) Polyvinyl butyral interlayers reinforced with polyethylene terephthalate film.
      - 3) Cast-in-place and cured-transparent-resin interlayer.
      - 4) Cast-in-place and cured-transparent-resin interlayer reinforced with polyethylene terephthalate film.
  - 6. Interlayer Color: Clear unless otherwise indicated.
  - 7. Low E Treatment: manufacturer's standard.

## 2.7 CONSTRUCTION ACCESSORIES

- A. Sealants:
  - 1. Provide manufacturer recommended sealants maintain watertight conditions.
  - 2. Glazed units to be factory installed and sealed per manufacturer's design as tested to meet the design requirements.

## 2.8 FABRICATION

- A. Skins are adhered to engineered wood frames with core materials and bonding agents that permanently lock skin to frame.
- B. Fabricate fiberglass work to be rigid and free of defects, warp, or buckle. Accurately form fiberglass and metal cladding to required sizes and profiles, with minimum radius for material thickness. Where practical, fit and assemble units in manufacturer's plant. To ensure proper assembly at Project site, clearly identify work that cannot be permanently factory assembled before shipment.

## PART 3 - EXECUTION

### 3.1 GENERAL

- A. Install doors in accordance with manufacturer's installation guidelines and recommendations.

**3.2 EXAMINATION**

- A. Examine substrates, areas, and conditions, with Installer present, for compliance with requirements for installation tolerances and other conditions affecting performance of the Work.
- B. Inspect door prior to installation.
- C. Inspect rough opening for compliance with door manufacturer recommendations. Verify rough opening conditions are within recommended tolerances.
- D. Proceed with installation only after unsatisfactory conditions have been corrected.

**3.3 INSTALLATION**

- A. General: Install assemblies plumb, rigid, properly aligned, and securely fastened in place. Comply with Drawings and manufacturer's written instructions.
- B. Install jamb assembly.
  - 1. Caulk sill along outside edge and ½ inch in from edge of subfloor.
  - 2. Set door unit into center of opening and tack in place.
  - 3. Shim hinge then latch side jambs straight. Inspect jamb for square, level and plumb.
  - 4. Fasten hinge side jamb to studs.
  - 5. Verify door opens freely and weatherstrip meets door evenly.
  - 6. Verify door sweep contacts threshold evenly.
  - 7. Fasten latch side jamb to studs.
- C. Caulk outside perimeter of door unit between brickmold and wall face, along front side of threshold, and between jamb sides and threshold.

**3.4 PROTECTION**

- A. Protect installed doors from damage.

**3.5 ADJUSTING AND CLEANING**

- A. Final Adjustments: Check and readjust operating hardware items immediately before final inspection. Leave work in complete and proper operating condition. Remove and replace defective work, including hollow-metal work that is warped, bowed, or otherwise unacceptable.
- B. Prime-Coat Touchup: Immediately after erection, sand smooth rusted or damaged areas of prime coat and apply touchup of compatible air-drying, rust-inhibitive primer.

**END OF SECTION 081613**

# Appendix B

# Technical Drawings





# GUSTE III COMMUNITY INTERIOR & EXTERIOR REPAIRS

OWNER: HOUSING AUTHORITY OF NEW ORLEANS (HANO)  
GUSTE HIGHRISE MAINTENANCE COMMUNITY  
1301 SIMON BOLIVAR AVENUE  
NEW ORLEANS, LA 70113

## ABBREVIATIONS

AFF.	ABOVE FINISH FLOOR
BLDG	BUILDING
CNO	CITY OF NEW ORLEANS
CLR.	CLEAR
CMU	CONCRETE MASONRY UNIT
CONC.	CONCRETE
D/W	DRIVEWAY
DIM. PT.	DIMENSION POINT
EO	EDGE OF
E.F.	EXHAUST FAN
(E)	EXISTING
EX.	EXISTING
EXIST.	EXISTING
EXT.	EXTERIOR
F.F.	FINISH FLOOR
F.O.	FACE OF
FDN	FOUNDATION
GSM	GALVANIZED SHEET METAL
GB	GRAB BAR
HDG	HOT DIPPED GALVANIZED
LAV.	LAVATORY
MFG.	MANUFACTURER
MTL.	METAL
MIN	MINIMUM
(N)	NEW
N.I.C.	NOT IN CONTRACT
NTP	NOTICE TO PROCEED
O.C.	ON CENTER
O/	OVER
PTD	PAPER TOILET DISPENSER
PT	PRESSURE TREATED
R/R	REMOVE AND REPLACE
RA.	RETURN AIR
RAG	RETURN AIR GRILLE
REQ'D	REQUIRED
S.C.D.	SEE CIVIL DRAWINGS
S.A.M.	SELF ADHERING MEMBRANE
S/W	SIDEWALK
SIM	SIMILAR
STL	STEEL
STRL	STRUCTURAL
T.B.D.	TO BE DETERMINED
(TBR&R)	TO BE REMOVED AND REPLACED
TPD	TOILET PAPER DISPENSER
T&B	TOP AND BOTTOM
T.O.	TOP OF
(TYP)	TYPICAL
U	UNDERCUT
(UIP)	USE IN PLACE
W.C.S.T.	WOOD COMPOSITE SUBSTRATE TRIM

IFB # 24-912-33

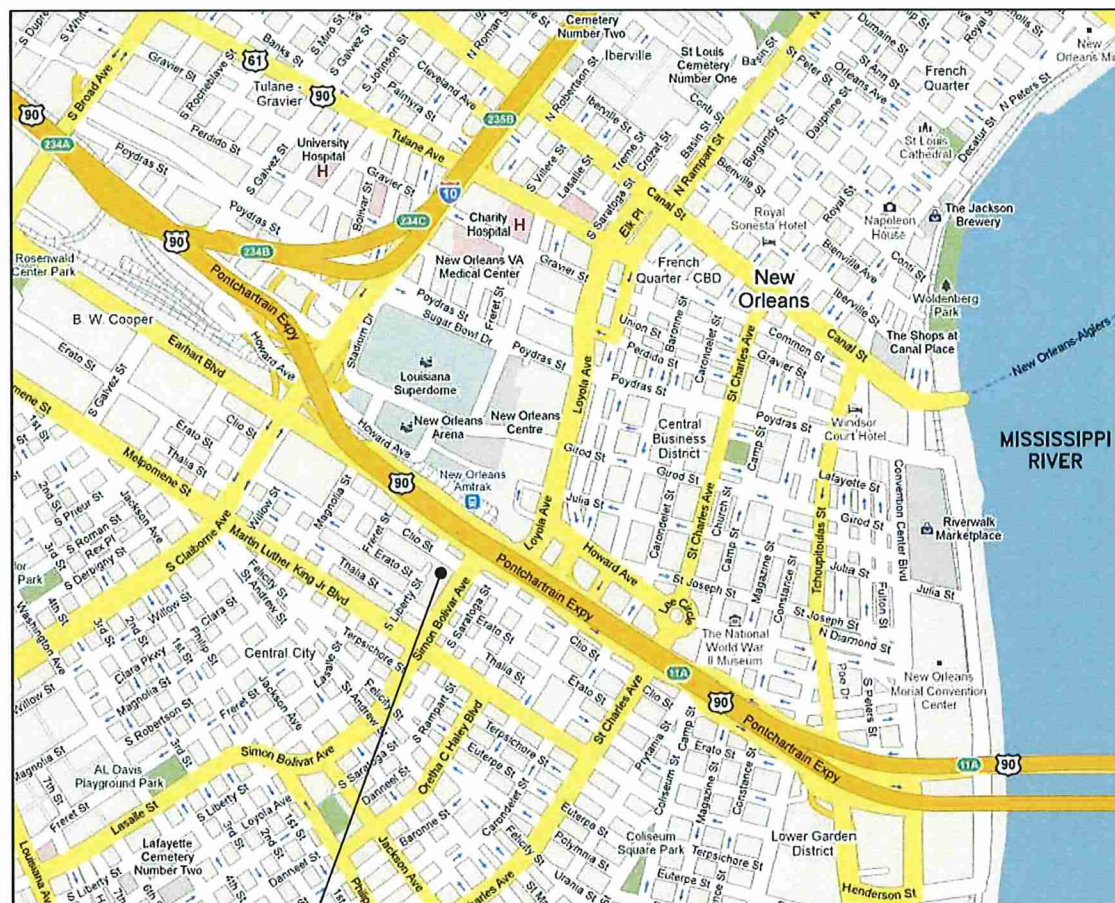

GUSTE III  
PROJECT LOCATION

## LOCATION MAP

STANDARD SPECIFICATIONS  
THE 2015 CITY OF NEW ORLEANS  
STANDARD SPECIFICATIONS AS AMENDED  
BY THE PROJECT SPECIFICATIONS, SHALL  
GOVERN.

## SHEET INDEX

G-001	TITLESHEET
G-002	GENERAL NOTES
G-003	SCOPE OF WORK
C-001	OVERALL SITE PLAN
C-002	ACCESSIBLE ROUTES IMPROVEMENTS
C-002A	ACCESSIBLE ROUTES IMPROVEMENTS
C-003	ACCESSIBLE ROUTES IMPROVEMENTS
C-003A	ACCESSIBLE ROUTES IMPROVEMENTS
C-004	ACCESSIBLE ROUTES IMPROVEMENTS
C-004A	ACCESSIBLE ROUTES IMPROVEMENTS
C-005	ACCESSIBLE ROUTES IMPROVEMENTS
C-005A	ACCESSIBLE ROUTES IMPROVEMENTS
C-006	ACCESSIBLE ROUTES IMPROVEMENTS
C-006A	ACCESSIBLE ROUTES IMPROVEMENTS
C-007	ACCESSIBLE ROUTES IMPROVEMENTS
C-008	EXTERIOR IMPROVEMENTS
C-009	EXTERIOR IMPROVEMENTS
C-010	EXTERIOR IMPROVEMENTS
C-010A	EXTERIOR IMPROVEMENTS
C-011	EXTERIOR IMPROVEMENTS
C-012	NOT USED
C-013	NOT USED
C-014	EXTERIOR IMPROVEMENTS
C-015	EXTERIOR IMPROVEMENTS
C-016	EXTERIOR IMPROVEMENTS
C-017	EXTERIOR IMPROVEMENTS
C-018	ACCESSIBLE ROUTE IMPROVEMENTS
C-018A	ACCESSIBLE ROUTE IMPROVEMENTS
C-019	EXTERIOR IMPROVEMENTS
C-020	EXTERIOR IMPROVEMENTS
C-021	EXTERIOR IMPROVEMENTS
C-022	ACCESSIBLE ROUTE IMPROVEMENTS
C-023	EXTERIOR IMPROVEMENTS
C-024	RAMP DETAILS
C-024A	RAMP DETAILS
C-025	RAMP DETAILS
C-026	EXTERIOR IMPROVEMENTS
C-027	EXTERIOR IMPROVEMENTS
A-100	OVERALL SITE PLAN
A-100.1	TOILET ROOM DETAILS
A-101	FIRST FLOOR OVERALL PLAN FOR "M" BUILDING
A-102	SECOND FLOOR OVERALL PLAN FOR "M" BUILDING
A-103	THIRD FLOOR OVERALL PLAN FOR "M" BUILDING
A-104	FOURTH FLOOR OVERALL PLAN FOR "M" BUILDING
A-111 - A-118	TYPICAL UNIT PLANS
A-120 - A-130	SCOPE OF WORK SHEETS
A-141 - A-142	MISCELLANEOUS DETAILS
A-143	PHOTOS

## APPENDIX B

G-1	INDEX OF DRAWINGS, SITE PLAN, MISC.
A-1	FLOOR PLANS
A-2	EXTERIOR ELEVATIONS, ALTERATIONS, TO EXISTING METALWORK
A-3	DETAILS

## STANDARD PLANS

ADA1	CURB RAMPS FOR STREET CONSTRUCTION
ADA2	CURB RAMPS FOR STREET CONSTRUCTION
ADA3	INTERSECTION LAYOUT FOR STREET CONSTRUCTION
ADA4	CURB RAMPS FOR STREET CONSTRUCTION
DW1	STANDARD DRIVEWAYS FOR STREET CONSTRUCTION
MC1	MISC. DETAILS FOR STREET CONSTRUCTION
PM1	TYPICAL APPLICATION OF PAVEMENT MARKINGS
RW1	TYPICAL RDWY. SECTION FOR STREET CONSTRUCTION
RW2	TYPICAL RDWY. SECTION FOR STREET CONSTRUCTION
RW3	TYPICAL RDWY. SECTION FOR STREET CONSTRUCTION
RW4	TYPICAL RDWY. SECTION FOR STREET CONSTRUCTION

## CODE COMPLIANCE

- ALL WORK IS TO BE COMPLAINT WITH FOLLOWING STANDARDS:
- IBC 2018 AND ICE A117.1 - 2009 (THROUGHOUT)
  - ADA 2010 STANDARDS, ICC A117.1 2009, CURRENT LOCAL REQUIREMENTS FOR (ALL PUBLIC & COMMON AREAS) & (PUBLIC SIDEWALKS & CURB RAMPS) WHERE APPROPRIATE THE PROW STANDARDS PUBLISHED BY THE ACCESS BOARD MAY BE APPLIED.
  - ADA 2010 STANDARDS AS REVISED BY THE HUD DEEMING NOTICE (ALL UFAS/ADA UNITS)

ECM PROJECT No. 22462.14

JUN. 21, 2024



THESE PLANS AND SPECIFICATIONS HAVE BEEN PREPARED BY ME, OR UNDER MY CLOSE PERSONAL SUPERVISION, AND TO THE BEST OF MY KNOWLEDGE AND BELIEF, THEY COMPLY WITH ALL CITY AND STATE REQUIREMENTS. I WILL OBSERVE THE WORK.

BY: *N. GUY WILLIAMS*  
REGISTRATION No: 3907

REVISIONS	BY

ARCHITECT/ENGINEER:  
**ECM Consultants, Inc.**  
ENGINEERS - ARCHITECTS - CONSTRUCTION MANAGERS  
1301 CLEARVIEW PKWY. SUITE 200  
METAIRIE, LOUISIANA 70001  
PHONE: (504) 885-4080, FAX: (504) 885-1439  
EMAIL: mail@ecmconsultants.com

OWNER:  
HOUSING AUTHORITY  
OF NEW ORLEANS  
2051 SENATE ST. BUILDING B. RM. 202  
NEW ORLEANS, LOUISIANA 70122

PROJECT:  
GUSTE III COMMUNITY  
INTERIOR & EXTERIOR REPAIRS  
SHEET TITLE:  
TITLESHEET

DRAWN  
M.L.M. & A.E.D.  
CHECKED  
N.G.W.  
DATE  
JUN. 21, 2024  
SCALE  
AS SHOWN  
JOB NO.  
22462.14  
SHEET NO.

G-001



**GENERAL NOTES:**

- CONTRACTOR TO VISIT SITE AND EXAMINE ALL EXIST. CONDITIONS, PRIOR TO SUBMITTING A PROPOSAL.
- SCOPE OF WORK APPLIES ONLY TO THE GUSTE III COMMUNITY DEVELOPMENT LOCATED AT 1301 SIMON BOLIVAR, NEW ORLEANS, LA 70113. CONTRACTOR SHALL ASSUME ALL UNITS IN THE BUILDING ARE OCCUPIED. CONTRACTOR SHALL TAKE ALL MEASURES NECESSARY TO PROTECT THE EXISTING FINISHES AND CONTENTS OF THE UNITS AND COMMON AREAS (WORK AREAS) AND TO MITIGATE ANY INCONVENIENCE TO THE RESIDENTS.
- CONTRACTOR SHALL COORDINATE ALL SELECTIVE DEMOLITION AND CONSTRUCTION ACTIVITIES WITH THE PROPERTY MANAGER AND HANO. PROPERTY MANAGER AND HANO SHALL BE NOTIFIED A MINIMUM OF THREE (3) BUSINESS DAYS PRIOR TO BEGINNING ANY WORK IN ANY UNIT. PROPERTY MANAGEMENT CONTACT INFORMATION AND THE HANO REPRESENTATIVE'S CONTACT INFORMATION WILL BE PROVIDED AT THE PRECONSTRUCTION CONFERENCE.
- CONTRACTOR PARKING SHALL BE LIMITED TO LEGAL STREET PARKING. CONTRACTOR VEHICLES THAT BLOCK DRIVES WILL BE SUBJECT TO BEING TOWED AT THE EXPENSE OF THE CONTRACTOR (VIA CHANGE ORDER CREDIT IF REQUIRED).
- ALL MATERIALS SHALL BE NEW AND SHALL BE IN ACCORDANCE WITH THE CONTRACT DOCUMENTS, UNLESS OTHERWISE NOTED.
- UPON ISSUANCE OF THE NOTICE TO PROCEED, CONTRACTOR SHALL SCHEDULE A VISITATION TO EACH RESIDENTIAL UNIT WITH PROPERTY MANAGEMENT AND HANO SO THAT ALL NECESSARY MEASUREMENTS FOR ORDERING AND/OR FABRICATING MATERIALS MAY BE DETERMINED. AS THE RESIDENTIAL UNITS ARE OCCUPIED, ONLY ONE VISITATION WILL BE ALLOWED PER UNIT FOR THIS PURPOSE. FAILURE TO TAKE PROPER MEASUREMENTS WILL NOT BE CAUSE FOR AN INCREASE TO CONTRACT PRICE AND/OR TIME.
- NO WORK SHALL BEGIN UNTIL ALL MATERIALS ARE AVAILABLE AND READY FOR INSTALLATION IN ANY GIVEN WORK AREA IN THE BLDG.
- DEMOLISHED MATERIALS SHALL BE REMOVED FROM THE BUILDING THE SAME DAY THAT THEY ARE REMOVED. DEMOLISHED MATERIALS SHALL NOT BE LEFT IN THE UNITS NOR STORED ON SITE EXCEPT IN APPROVED DUMPSTERS.(NOTE:HANO HAS NO INTEREST IN RETAINING ANY SALVAGEABLE MATERIALS. SHOULD THE CONTRACTOR CHOOSE TO SALVAGE ANY MATERIALS, THEY MAY NOT BE SOLD ON-SITE.)
- CONTRACTOR SHALL COORDINATE THE LOCATION OF DUMPSTER(S) WITH PROPERTY MANAGEMENT AND HANO. CONTRACTOR SHALL PROCURE AND PAY FOR ALL PERMITS FOR DUMPSTER USE THAT MAY BE REQUIRED BY GOVERNING AUTHORITIES HAVING JURISDICTION. CONTRACTOR SHALL POLICE ITS DUMPSTERS. NEITHER HANO NOR PROPERTY MANAGEMENT ASSUMES ANY RESPONSIBILITY FOR THE MISUSE OF THESE DUMPSTERS BY ANYONE. CONTRACTOR SHALL PROVIDE A STAGING PLAN FOR REVIEW AND APPROVAL BY PROPERTY MANAGEMENT AND HANO.
- CONTRACTOR SHALL LEAVE THE WORK AREAS IN A BROOM-SWEPT CONDITION AT THE END OF EACH WORKDAY. CONTRACTOR SHALL PERFORM A THOROUGH "POWDER PUFF" CLEANING AT EACH WORK AREA UPON COMPLETION OF THE WORK. FINAL CLEANUP WORK SHALL BE PERFORMED BY A PROFESSIONAL CLEANING SERVICE.
- SHOULD THE WORK WITHIN A UNIT EXTEND BEYOND ONE (1) DAY CONTRACTOR SHALL IMMEDIATELY NOTIFY PROPERTY MANAGEMENT AND HANO PRIOR TO 2:00 PM. CONTRACTOR SHALL TAKE ALL MEASURES TO REMEDY ANY POTENTIALLY DANGEROUS CONDITIONS & OTHER ELEMENTS THAT MIGHT CAUSE A MATERIAL INCONVENIENCE TO THE RESIDENTS. CONTRACTOR SHALL PROVIDE TEMPORARY BARRIERS TO KEEP ALL RESIDENTS FROM ANY POTENTIALLY DANGEROUS AREAS. CONTRACTOR TO PROVIDE PLYWOOD COVER AT ANY UNSECURED OPENING TO THE EXTERIOR. ALL SUCH MEASURES SHALL BE INCLUDED THE CONTRACT LUMP SUM.
- CONTRACTOR SHALL MAKE ITS BEST EFFORT TO AVOID DAMAGE TO THE EXISTING FINISHES. ANY REQUIRED REMEDIAL WORK RESULTING FROM CONTRACTOR ACTIVITIES SHALL BE PERFORMED AND PAID FOR BY THE CONTRACTOR. SHOULD THE CONTRACTOR FAIL TO PERFORM SUCH REMEDIAL WORK, HANO WILL COMPLETE THIS WORK AND BACK CHARGE THE COST TO THE CONTRACTOR PLUS TEN PERCENT (10%) FOR ADMINISTRATIVE COSTS.
- SCHEDULE: CONTRACTOR SHALL PROVIDE AN INITIAL SCHEDULE FOR THE WORK AT THE PRE-CONSTRUCTION CONFERENCE. THE SCHEDULE SHALL INCLUDE THE FOLLOWING AT A MINIMUM:
  - CONTRACT START DATE AS DEFINED BY NOTICE TO PROCEED(NTP)
  - CONTRACT COMPLETION DATE AS DEFINED BY THE (NTP)
  - TIME FRAMES FOR NOTIFYING RESIDENTS OF A MINIMUM OF THREE (3) BUSINESS DAYS. (FAILURE TO PROPERLY NOTIFY RESIDENTS IN A TIMELY FASHION SHALL NOT BE CAUSE FOR AN INCREASE IN THE CONTRACT TIME. NOTIFICATION TO BE MADE BY FACILITY MANAGEMENT. CONTRACTOR TO ALLOW TIME IN THE SCHEDULE FOR THIS PRIOR NOTIFICATION.)

- REMEDIAL WORK ON A FLOOR-BY-FLOOR OR UNIT BASIS
  - CONTRACTOR PUNCH ON A FLOOR-BY-FLOOR OR UNIT BASIS
  - ARCHITECTURAL PUNCH ON A FLOOR-BY-FLOOR BASIS
  - AN UPDATED SCHEDULE SHALL BE SUBMITTED BY CONTRACTOR UPON COMPLETION OF ITS REVIEW OF THE WORK AREAS.
- CONTRACTOR SHALL BE RESPONSIBLE FOR MAINTAINING ALL UTILITIES TO THE BUILDING. CONTRACTOR MAY USE EXISTING UTILITIES AS REQUIRED TO PERFORM THE REQUIRED WORK. ANY DISRUPTION TO THESE UTILITIES SHALL BE COORDINATED WITH PROPERTY MANAGEMENT AND HANO A MINIMUM OF THREE (3) BUSINESS DAYS IN ADVANCE. LENGTH OF SERVICE INTERRUPTION SHALL ALSO BE PRE-DETERMINED PRIOR TO INTERRUPTION.
  - CONTRACTOR SHALL BE SOLELY RESPONSIBLE FOR DEVELOPING & MAINTAINING ALL SAFETY MEASURES AND PROGRAMS ASSOCIATED WITH THE WORK AND HANO ASSUMES NONE OF THIS RESPONSIBILITY.
  - CONTRACTOR SHALL EXERCISE CARE WHEN WORKING AROUND THE LANDSCAPING. ANY PLANTS OR SOD THAT IS DAMAGED DURING THE COURSE OF PERFORMING THE WORK SHALL BE REPLACED BY THE CONTRACTOR WITH LIKE MATERIALS.
  - CONTRACTOR SHALL PROPERLY DEMARCAT E AND PROTECT ALL WORK AREAS AS NECESSARY TO PROTECT THE PUBLIC AND RESIDENTS. THE WORK AREAS SHALL BE PROPERLY PROTECTED AT THE END OF EACH WORKDAY.
  - CONTRACTOR SHALL COORDINATE THE USE OF ONE (1) ELEVATOR CAR WITH PROPERTY MANAGEMENT AND HANO AT THE 'M' BUILDING. THIS INCLUDES THE POSSIBILITY OF LOCKING OUT THE CAR FOR THE CONTRACTOR'S USE ONLY, WHICH IS NOT GUARANTEED. CONTRACTOR SHALL PROTECT THE INTERIOR OF THE ASSIGNED CAR WITH PADS ON THE WALLS AND WITH PLYWOOD 4' UP AT THE OUTSIDE OF THE PAD AND PLYWOOD ON THE FLOOR. CONTRACTOR SHALL INSTALL AND MAINTAIN SIGNS ON THE ELEVATOR DOORS AT EACH FLOOR WITH THE FOLLOWING VERBIAGE:

**CAUTION<sup>1</sup>**

ELEVATOR CLOSED<sup>2</sup>  
FOR  
CONSTRUCTION<sup>2</sup>  
DO NOT USE<sup>2</sup>

- LETTERS SHALL BE PRINTED IN RED ON 8-1/2" X 11" PAPER AND LAMINATED. THE FONT SHALL BE ARIAL 100<sup>1</sup> AND 72<sup>2</sup> AS INDICATED ABOVE. INSTALL SIGNS WITH REMOVABLE ADHESIVE. DO NOT MECHANICALLY FASTEN THE SIGNS. ENSURE THAT SIGNS DO NOT INTERFERE WITH THE OPERATION OF THE ELEVATOR DOORS.
- CONTRACTOR TO VERIFY ALL DIMENSIONS AND EXISTING CONDITIONS PRIOR TO THE ORDERING OF MATERIALS AND THE START OF WORK. ANY DISCREPANCIES FOUND SHALL BE BROUGHT IMMEDIATELY TO THE ATTENTION OF THE ARCHITECT/ENGINEER FOR RESOLUTION.
- CONTRACTOR SHALL DOCUMENT ALL EXISTING CONDITIONS WHERE WORK MAY BE PERFORMED AS DESCRIBED IN A MANNER AS DESCRIBED IN THE SUPPLEMENTAL INFORMATION SECTION PROVIDED IN THE SPECIFICATIONS. PRE-CONSTRUCTION, CONSTRUCTION AND FINAL COMPLETION PHOTOS SHALL BE PROVIDED TO DOCUMENT THE EXISTING CONDITIONS AND THE WORK PERFORMED.
- THE CONTRACTOR SHALL PROVIDE & PAY FOR ALL REQ'D PERMITS REQUIRED BY THE GOVERNMENTAL AGENCIES HAVING JURISDICTION.

**STAGING NOTES:**

- CONTRACTOR SHALL COORDINATE ALL WORK WITH THE GUSTE PROPERTY MANAGEMENT DEPARTMENT AND HANO TO ENSURE MIN. DISRUPTION WITH THE OPERATIONS OF THE FACILITY. REFER TO GENERAL NOTES FOR THE PRIOR NOTICE REQUIREMENTS. AS THE WORK PROGRESSES, THE CONTRACTOR SHALL CONTINUE TO PROVIDE PRIOR NOTIFICATION IN ORDER TO COORDINATE THEIR MOVEMENT WITHIN THE FACILITY.
- CONTRACTOR TO SUPPLY FOR REVIEW AND APPROVAL A SCHEDULE OF THE WORK INDICATING THE CONTRACTOR'S PLAN FOR THE PROGRESS OF THE CONSTRUCTION. THIS SCHEDULE SHALL INCLUDE THE ANTICIPATED DATES WHEN WORK IS TO BE PERFORMED AT THE BUILDING'S COMMON AREAS. WORK WITHIN THE UNITS SHALL BE GIVEN AN ANTICIPATED START TIME AND COMPLETION TIME FOR THAT UNIT'S WORK.
- CONTRACTOR SHALL PROVIDE TEMPORARY BARRIER(S) TO SEPARATE THE BUILDING TENANTS AND THE PUBLIC FROM ANY PORTION OF THE WORK BEING PERFORMED.
- CONTRACTOR SHALL AT ALL TIMES PROVIDE UNOBSTRUCTIVE ACCESS TO ALL EXITS FROM BUILDING. AT NO POINT SHALL ACCESS TO EXITS BE BLOCKED.
- CONTRACTOR SHALL PROVIDE A STAGING PLAN SHOWING THE LOCATION OF DUMPSTERS, STAGING OF MATERIALS, PORTABLE TOILETS, ETC. AT PRECONSTRUCTION CONFERENCE FOR REVIEW AND APPROVAL BY HANO.

**DEMOLITION NOTES:**

- CONTRACTOR IS RESPONSIBLE FOR VERIFYING THE EXTENT, NATURE, AND SCOPE OF WORK DESCRIBED IN THE DOCUMENTS WITH THE EXISTING CONDITIONS IN THE FIELD. CONTRACTOR SHALL PROVIDE ALL LABOR, MATERIALS, EQUIPMENT, SERVICING, SUPERVISION, ETC. TO EXECUTE ALL PHASES OF THE WORK.
- CONTRACTOR SHALL CONTINUOUSLY AND CONSISTENTLY MAINTAIN THE SAFETY OF THE STRUCTURE, WORKERS AND THE GENERAL PUBLIC. NO STRUCTURAL MEMBER SHALL BE CUT OR MANIPULATED IN ANYWAY WITHOUT PRIOR APPROVAL. THE CONTRACTOR SHALL BE FULLY RESPONSIBLE FOR THE STABILITY OF THE STRUCTURE. SHORING TO MAINTAIN STRUCTURAL INTEGRITY OF THE BUILDING SHALL BE USED AS REQUIRED.
- CONTRACTOR TO VERIFY ALL DIMENSIONS IN THE FIELD PRIOR TO THE START OF THE WORK. THE EXISTING CONSTRUCTION MAY VARY AT DIFFERENT AREAS OF THE BUILDINGS. CONTRACTOR TO VERIFY ALL CONDITIONS PRIOR TO THE START OF THE WORK. NOTIFY ARCHITECT/ENGINEER OF ANY DISCREPANCIES FOUND.
- CONTRACTOR TO PROTECT EXISTING CONSTRUCTION TO REMAIN. ANY DAMAGE DUE TO CONTRACTOR ACTIVITY SHALL BE REPAIRED OR REPLACED AT NO COST TO THE OWNER.
- CONTRACTOR TO PROVIDE COMPLETE DUST PROOF ENCLOSURE AT ALL AREAS WHERE DEMOLITION IS TO OCCUR.
- CONTRACTOR TO COMPLY WITH ALL OSHA, NFPA AND OTHER APPLICABLE CODES AND REGULATIONS ADDRESSING THIS PROJECT.
- ALL UTILITIES ARE TO BE IDENTIFIED BY THE CONTRACTOR.
- REMOVE ALL DEMOLITION WASTE MATERIALS FROM PROJECT SITE AND LEGALLY DISPOSE OF ALL WASTE MATERIALS ON A DAILY BASIS. DO NOT ALLOW DEMOLISHED MATERIALS TO ACCUMULATE ON SITE. REMOVE AND TRANSPORT DEBRIS IN A MANNER TO PREVENT SPILLAGE ONTO ADJACENT AREAS OR ROADWAYS.

**PRODUCT DATA NOTES:**

- FOR DOOR CLOSURES, PROVIDE NORTON RIXSON 2800ST SERIES CLOSER FROM ASSA ABLOY OR APPROVED EQUAL. FINISH TO MATCH EXISTING. SEE NFPA 101 REQUIREMENT BELOW.
- FOR NEW THRESHOLDS TO REPLACE EXISTING, PROVIDE THRESHOLD FROM ASSA ABLOY OR APPROVED EQUAL. THRESHOLDS MUST MEET ALL HANDICAP REQUIREMENTS & RESTRICTIONS. REFER TO DETAILS 1, 2, & 3 ON SHEET A-142 FOR TYPE OF THRESHOLDS TO PROVIDE.
- PROVIDE BEVELED THRESHOLD AT THE INTERIOR SIDE OF THE DOORS INDICATED. FOR OFFSETS BETWEEN ¼" & ½" AT OFFSETS BETWEEN ½" AND ¾", PROVIDE THRESHOLD PER DETAIL #2 ON SHEET A-142. AT OFFSETS BETWEEN ¾" AND 1", PROVIDE THRESHOLD PER DETAIL #3 ON SHEET A-142. AT ENTRANCE DOORS TO LOBBY REFER TO DETAIL #1 ON SHEET A-142 FOR THRESHOLD TYPES.
- ALL OUTLETS 6' FROM A WATER SOURCE MUST BE A GFI OUTLET. CONTRACTOR TO PROVIDE GFI OUTLETS AT THESE LOCATIONS.
- PROVIDE NEW UNISEX TOILET SIGNAGE AT FOURTH FLOOR PUBLIC TOILET ROOMS IN COMMUNITY ROOM. SIGNAGE TO BE INSTALLED PER HANDICAP REQUIREMENTS. (2 TOTAL)
- PROVIDE NEW VANITY LAVATORY AND BASE CABINET TO MATCH EXISTING. LAVATORY TO BE PER GERBER - MAXWELL DROP-IN SINK MODEL NO. G0012834CH OR APPROVED EQUAL. LAVATORY MUST COMPLY WITH ADA REQUIREMENTS FOR ACCESSIBILITY. FAUCET TO BE AMERICAN STANDARD 75-509 SOFT 2 HANDLE CENTERSET WITH LEVER HANDLES OR APPROVED EQUAL. SINK BASE TO BE HASB24-BPD-STORE TO BE SHAKER II - PARTIAL OVERLAY FOR TIDWELL CABINETRY. COLOR OF VANITY TO BE BRIGHT 3"X30" FILLER AND TOE BOARD MOLDING.
- PROVIDE NEW TUB SURROUND WHERE INDICATED. PROVIDE KOHLER-STERLING ENSEMBLE™ MEDLEY 60"x30" VIKCELL BATH/SHOWER (71370110) OR APPROVED EQUAL. CONTRACTOR TO MATCH THE TUB'S EXISTING CONDITIONS AT EACH TUB TO BE REPLACED.
- PROVIDE LAVGUARD 2 E-Z SERIES WASTE AND SUPPLY PIPE COVERS COMPLYING WITH ADA REQUIREMENTS OR APPROVED EQUAL.
- ATTACHMENT "C" IN THE SPECIFICATION IS TO PROVIDE INFORMATION ON THE REQUIREMENTS FOR THE BALCONY DOORS TO BE REPLACED.
- PROVIDE MAILBOX SUITES PER VERSATILE 4C MODEL No.4C06D-10+ OR APPROVED EQUAL. MAILBOX SUITE, MUST BE USPS APPROVED AND MEET ADA INSTALLATIONS REQUIREMENTS SEE DETAIL #2 ON SHEET A-141 FOR LAYOUTS.
- PROVIDE NEW KITCHEN SINK WHERE INDICATED. SINK TO BE ELKAY CROSSTOWN STAINLESS STEEL 31-1/2" X 18-1/2" X 9" EQUAL DOUBLE BOWL UNDER MOUNT SINK. MODEL ECTRU31179T OR APPROVED EQUAL.

**STRUCTURAL NOTES:**

**WELDING NOTES:**

- ALL WELDING SHALL BE ELECTRIC WELDING, WORKMANSHIP AND TECHNIQUE, WHERE APPLICABLE SHALL CONFORM TO THE AMERICAN WELDING SOCIETY STRUCTURAL WELDING CODE AWS D1.1. ELECTRODE TO BE USED IN WELDING WILL BE E70XX.
- FIELD VERIFY DIMENSIONS BEFORE ANY FABRICATION.
- ALL SURFACES AT THE WELDING JOINTS TO BE GROUND SMOOTH AND PAINTED AFTER THE WELDING.

**CONCRETE NOTES:**

- CONC. SHALL HAVE A MIN. COMPRESSIVE STRENGTH OF (fc) 4000 PSI AT 28 DAYS.
- REINFORCING STEEL SHALL HAVE A MIN. YIELD STRENGTH(Fy) OF 60000 PSI.
- ARCYLIC LATEX BONDING AGENT OR EQUAL APPROVED BY THE ENGINEER TO BE USED WHEREVER OLD CONC. SURFACE MEETS FRESHLY POURED CONCRETE. SURFACE PREPARATION AND BONDING AGENT APPLICATION AGENT, ACCORDING TO MANUFACTURERS RECOMMENDATION.

**PAINTING NOTES:**

- ALL HANDRAILS TO BE PAINTED WITH HYDROGLOSS SINGLE COMPONENT WATER BASED URETHANE PAINT OR EQUAL APPROVED BY THE ENGINEER. COLOR TO MATCH EXISTING HANDRAILS.

**GUARDRAIL NOTES:**

- HANDRAILS AND GUARDRAILS SHALL BE DESIGNED TO RESIST A LINEAR LOAD OF 50 POUNDS PER LINEAR FOOT (PLF) (0.73 kN/m) IN ACCORDANCE WITH SECTION 4.5.1.1 OF ASCE-7.

**BOLT NOTES:**

- ALL NEW BOLTS USED FOR ATTACHING NEW GUARDRAIL TO RETAINING WALL OR PAVEMENT SHALL MATCH THE SPECIFICATIONS OF A ¾" HILTI KWIK BOLT AT MIN.

**DIMENSIONS NOTES:**

- DIMENSIONS ON PLANS AND DRAWINGS ARE (±). ALL DIMENSIONS TO BE FIELD VERIFIED BY THE CONTRACTOR PRIOR TO THE START OF WORK AND NOTIFIED TO THE ENGINEER IN CASE OF ANY DISCREPANCIES. ALL MEASUREMENTS TO BE FIELD VERIFIED BEFORE ORDERING MATERIALS AND FABRICATION OF COMPONENTS.

**SAW CUTTING NOTES:**

- CONCRETE SAW CUTTING WILL BE REQUIRED AT RAMP LOCATIONS. CONCRETE TO BE CHIPPED 3 INCHES AFTER SAW CUTTING BEFORE PLACING FRESH CONCRETE ALONG WITH BONDING AGENT TO FORM A GOOD BOND BETWEEN OLD AND NEW CONCRETE SURFACE.

**SIDEWALK AND DRIVEWAY NOTES:**

- ALL SIDEWALKS TO BE A MINIMUM OF 5 INCHES THICK AND ALL DRIVEWAYS TO BE A MINIMUM OF 6 INCHES THICK.
- NEW CONCRETE WORK TO MATCH THE EXISTING GRADE WHEN JOINING WITH ADJACENT CONCRETE.
- ALL CONNECTION TO THE EXISTING PAVEMENTS WILL BE LESS THAN 2% CROSS SLOPE AND WILL BE FREE OF ANY GAPS AND LEVEL CHANGES. CROSS SLOPE AND RUNNING SLOPE CANNOT EXCEED 2% AT LANDINGS, TURNS, DOORS AND DOOR MANEUVERING SPACES IN ANY DIRECTION.

**TRASH PAD NOTES:**

- TRASH PAD IS A 3' X 3' CONCRETE SIDEWALK ADJACENT TO ADA ACCESSIBLE ROUTE. FOR PURPOSE OF MEASUREMENT AND PAYMENT IT SHALL BE PAID AS REGULAR CONCRETE SIDEWALK.

**SLOPE NOTES:**

- ALL RAMP LENGTHS ARE BASED ON 7.5 % SLOPE. IF THE RAMP LENGTHS EXCEED 8.33% WHILE CONSTRUCTION THEN THEY SHALL BE REDONE TO MEET ADA REQUIREMENTS AT NO COST TO THE OWNER.

**NFPA 101 - DOOR SWINGS AND FORCE TO OPEN**

7.2.1.4.5 - THE FORCES REQUIRED TO FULLY OPEN ANY DOOR MANUALLY IN A MEANS OF EGRESS SHALL NOT EXCEED 15 LBF (67 N) TO RELEASE THE LATCH, 30 LBF (133 N) TO SET THE DOOR IN MOTION, AND 15 LBF (67 N) TO OPEN THE DOOR TO THE MIN. REQUIRED WIDTH, UNLESS OTHERWISE SPECIFIED IN 7.2.1.4.5.2 THROUGH 7.2.1.4.5.5.

7.2.1.4.5.2 - OPENING FORCES FOR INTERIOR SIDE-HINGED OR PIVOTED- SWINGING DOORS WITHOUT CLOSERS SHALL NOT EXCEED 5 LBF (22 N).

**NOTE:**  
CONTRACTOR TO INCLUDE IN HIS BID AN ALLOWANCE OF 10% OF HIS BID AMOUNT FOR USE AS THE OWNER SEES FIT FOR ITEMS THAT NEED TO BE ADDRESSED THAT ARE NOT IN THE PROJECT. AT THE END OF WORK, ANY MONEY REMAINING IN THE ALLOWANCE WILL BE ADDRESSED BY CHANGE ORDER TO ZERO OUT THE ALLOWANCE AMOUNT.

REVISIONS	BY

**ECM Consultants, Inc.**  
ENGINEERS - ARCHITECTS - CONSTRUCTION MANAGERS  
1301 CLEARVIEW PKWY. SUITE 200  
METAIRIE, LOUISIANA 70001  
PHONE: (504) 885-4080. FAX: (504) 885-1439  
EMAIL: mail@ecmconsultants.com

ARCHITECT/ENGINEER:  
HOUSING AUTHORITY  
OF NEW ORLEANS  
2051 SENATE ST. BUILDING B, RM. 202  
NEW ORLEANS, LOUISIANA 70122

OWNER:  
GUSTE III COMMUNITY  
INTERIOR & EXTERIOR REPAIRS  
SHEET TITLE:  
GENERAL NOTES

DRAWN M.L.M. & A.E.D.
CHECKED N.G.W.
DATE JUN. 21, 2024
SCALE AS SHOWN
JOB NO. 22462.14
SHEET NO. G-002

# SCOPE OF WORK SUMMARY

Report No.	Work Item Description	Unit	Quantity	Reference Notes	Page #
	1301 Clearview Pkwy, Metairie LA 70001				
	<b>Scope of Work for</b>	<b>Guste III Housing Development</b>			
	<b>Work Type</b>	Exterior			
1 & 4 (1226 RJR Way)	Removal of Concrete	SY	25.3	Refer to photos and drawings on Sheet- C002	# 4,#6
	Removal of Guardrails	LF	15	Refer to photos and drawings on Sheet- C002	# 4,#6
1 & 4 (1226 RJR Way)	Install new ramp as indicated on the drawings	SY	12.6	Refer to photos and drawings on Sheet- C002A	# 4,#6
	Install new concrete sidewalk as indicated on the drawings	SY	26.3	Refer to photos and drawings on Sheet- C002A	# 4,#6
	Install New Guardrail ,shape and size to match existing guardrails	LF	12	Refer to photos and drawings on Sheet- C002A	# 4,#6
	Install New Guardrail with handrail, shape and size to match existing guardrails	LF	50	Refer to photos and drawings on Sheet- C002A	# 4,#6
	Install new Concrete sidewalk (Trash pad)	SY	1	Refer to photos and drawings on Sheet- C002A	# 4,#6
	Sodding	SY	9.45	Refer to photos and drawings on Sheet- C002A	# 4,#6
	Required Regrading of ground as shown on plans	SY	8.95	Refer to photos and drawings on Sheet- C002A	# 4,#6
1 & 4 (1217 S LIBERTY ST)	Removal of concrete	SY	12.5	Refer to photos and drawings on Sheet- C003	# 4,#6
	Removal of Guardrails	LF	17	Refer to photos and drawings on Sheet- C003	# 4,#6
1 & 4 (1217 S LIBERTY ST)	Install new ramp as indicated on the drawings	SY	14.1	Refer to photos and drawings on Sheet- C003A	# 4,#6
	Install new concrete sidewalk as indicated on the drawings	SY	20.7	Refer to photos and drawings on Sheet- C003A	# 4,#6
	Install New Guardrail with Handrail ,shape and size to match existing guardrails	LF	67.5	Refer to photos and drawings on Sheet- C003A	# 4,#6
	Install New Guardrail ,shape and size to match existing guardrails	LF	13	Refer to photos and drawings on Sheet- C003A	# 4,#6
1 & 4 (2414 ERATO ST)	Removal of Concrete	SY	9	Refer to photos and drawings on Sheet- C004	# 4,#6
	Removal of Guardrails	LF	9.5	Refer to photos and drawings on Sheet- C004	# 4,#6
1 & 4 (2414 ERATO ST)	Install new ramp as indicated on the drawings	SY	13	Refer to photos and drawings on Sheet- C004A	# 4,#6
	Install sidewalk as indicated on the drawings	SY	15.1	Refer to photos and drawings on Sheet- C004A	# 4,#6
	Install New Guardrail with Handrail ,shape and size to match existing guardrails	LF	59	Refer to photos and drawings on Sheet- C004A	# 4,#6
	Install New Guardrail ,shape and size to match existing guardrails	LF	6	Refer to photos and drawings on Sheet- C004A	# 4,#6
1 & 4 (2320 ERATO)	Removal of Concrete	SY	12	Refer to photos and drawings on Sheet- C005	# 4,#6
	Removal of Guardrails	LF	11.5	Refer to photos and drawings on Sheet- C005	# 4,#6
1 & 4 (2320 ERATO)	Install new ramp as indicated on the drawings	SY	13	Refer to photos and drawings on Sheet- C005A	# 4,#6
	Install sidewalk as indicated on the drawings	SY	28	Refer to photos and drawings on Sheet- C005A	# 4,#6
	Install New Guardrail with Handrails, shape and size to match existing guardrails	LF	61.5	Refer to photos and drawings on Sheet- C005A	# 4,#6
	Install New Guardrail ,shape and size to match existing guardrails	LF	8	Refer to photos and drawings on Sheet- C005A	# 4,#6
	Install new Concrete trash pad	SY	1	Refer to photos and drawings on Sheet- C005A	# 4,#6
1 & 4 (1208 RJR Way)	Removal of Concrete	SY	2.7	Refer to photos and drawings on Sheet- C006	# 4,#6
	Removal of Guardrails	LF	14	Refer to photos and drawings on Sheet- C006	# 4,#6
1 & 4 (1208 RJR Way)	Install new ramp as indicated on the drawings	SY	13	Refer to photos and drawings on Sheet- C006A	# 4,#6
	Install sidewalk as indicated on the drawings	SY	20	Refer to photos and drawings on Sheet- C006A	# 4,#6
	Install New Guardrail with Handrail ,shape and size to match existing guardrails	LF	65.5	Refer to photos and drawings on Sheet- C006A	# 4,#6
	Install New Guardrail,shape and size to match existing guardrails	LF	10	Refer to photos and drawings on Sheet- C006A	# 4,#6
	Install new Concrete trash pad	SY	1	Refer to photos and drawings on Sheet- C006A	# 4,#6
2	Remove and replace concrete panels in parking area as shown on plans	SY	80	Refer to photos and drawings on Sheet- C007	# 4,#6
	Remove and install new accessible aisle striping as shown on plan. Also require yellow striping for reassigned Non-ADA parking spots.	LF	183	Refer to photos and drawings on Sheet- C007	# 4,#6
	Required Adjustment of Manhole	EA	1	Refer to photos and drawings on Sheet- C007	# 4,#6

3	New cocrrete sidewalk to be installed as described on plans	SY	1.5	Refer to drawings on Sheet- C007	# 4,#6
5 abcde	Remove and replace existing sidewalk as indicated on plans.	SY	12	Refer to drawings on Sheet- C008	#7
5 lmnop	Remove e existing sidewalk as indicated on the plans.	SY	29.7	Refer to drawings on Sheet- C008	#7
	New cocrrete sidewalk to be installed as described on plans	SY	27	Refer to drawings on Sheet- C008	#7
	Install new CNO curb ramp type 13	SY	2.7	Refer to drawings on Sheet- C008	#7
5 qr	Remove and replace existing sidewalk as indicated on the plans	SY	4.5	Refer to drawings on Sheet- C008	#7
5 s	Remove and replace existing curb ramp with CNO Type 5 curb ramp	SY	13	Refer to drawings on Sheet- C009	#7
5 t	Remove existing sidewalk as indicated on the plans	SY	33.4	Refer to drawings on Sheet- C009	#7
	Install New Concrete sidewalk as indicated on plans	SY	33.4	Refer to drawings on Sheet- C009	#7
5 z	Remove concrete panels as indicated on the plans	SY	1	Refer to drawings on Sheet- C009	#8
	Install concrete panels as indicated on the plans	SY	3	Refer to drawings on Sheet- C009	#8
5 Y & AA	Remove concrete sidewalk as indicated on the plans	SY	54	Refer to drawings on Sheet- C010	#8
	Install concrete sidewalk as indicated on the plans	SY	51.3	Refer to drawings on Sheet- C010	#8
	Install CNO Type 13 curb ramp	SY	2.7	Refer to drawings on Sheet- C010	#8
2310 ERATO ST	Remove Conc sidewalk as indicated on plans	SY	20	Refer to photos and drawings on Sheet- C010	# 4,#6
2310 ERATO ST	Remove and Replace Conc sidewalk as indicated on plans	SY	20	Refer to photos and drawings on Sheet- C010A	# 4,#6
	Install Handrails as indicated on plans	LF	32	Refer to photos and drawings on Sheet- C010A	# 4,#6
	Install New Conc Trash Pad	SY	1	Refer to photos and drawings on Sheet- C010	#9
5 CC	Remove and replace concrete sidewalk as indicated on the plans.	SY	12	Refer to drawing and photo on Sheet- C014	#9
5 DD	Remove existing Curb ramp and replace with CNO Type 5 ramp.	SY	16.5	Refer to drawings on Sheet- C009	#8
5 OO	Remove and replace concrete sidewalk as indicated on the plans. New sidewalk running slope to be under 5 percent slope max and cross slope to be under 2 percent slope max.	SY	26.5	Refer to drawing and photo on Sheet- C011	#8
	Install new Concrete trash pad	SY	1	Refer to drawing and photo on Sheet- C011	#9
6 efghi	Remove and replace east and west sidewalk at as indicated on plans at driveway near 1202-1204 Freret St. Remove and replace driveway as indicated on the plans. Provide detectable warning surfaces at curb ramps	SY	12	Refer to drawing and photo on Sheet- C014	#9
	Remove and replace driveway as indicated on the plans	SY	47	Refer to drawing and photo on Sheet- C014	#9
7	Remove and replace existing concrete panel as indicated on the plans.	SY	5.5	Refer to drawing and photo on Sheet- C015	#11
9b	Remove existing structures and obstructions as indicated on the plans	LS	1	Refer to drawing and photo on Sheet- C016	#11
	Remove existing sidewalk as indicated on the plans	SY	18.6	Refer to drawing and photo on Sheet- C016	#11
	Install new Ramp as indicated on the plans	SY	7.5	Refer to drawing and photo on Sheet- C016	#11
	Install new concrete sidewalk as indicated on the plans	SY	16.5	Refer to drawing and photo on Sheet- C016	#11
	Required New handrails. Shape and size to match existing	LF	29	Refer to drawing and photo on Sheet- C016	#11
	Install New Concrete trash pad	SY	1	Refer to drawing and photo on Sheet- C016	#11
9c	Remove existing structures and obstruction as indicated on the plans	LS	1	Refer to drawings and photos on Sheet- C017	#11
	Remove existing concrete sidewalk as indicated on the plans	SY	1	Refer to drawings and photos on Sheet- C017	#11
	Install new ramp as indicated on the plans	SY	3	Refer to drawings and photos on Sheet- C017	#11
	Install New concrete sidewalk as indicated on the plans	SY	0.2	Refer to drawings and photos on Sheet- C017	#11
	Required New handrails as shown on plans. Shape and size to match existing.	LF	13.5	Refer to drawings and photos on Sheet- C017	#11
	Install New Concrete trash pad	SY	1	Refer to drawings and photos on Sheet- C017	#11
9d	Remove existing structures and obstructions as indicated on the plans	LS	1	Refer to drawings and photos on Sheet- C017	#11
	Remove existing concrete sidewalk as indicated on the plans	SY	4.6	Refer to drawings and photos on Sheet- C017	#11
	Install new ramp as indicated on the plans	SY	5	Refer to drawings and photos on Sheet- C017	#11
	Install New concrete sidewalk as indicated on the plans	SY	3	Refer to drawings and photos on Sheet- C017	#11

	Required New handrails. Shape and size to match existing	LF	24.1	Refer to drawings and photos on Sheet- C017	#11
	Install New Concrete trash pad	SY	1	Refer to drawings and photos on Sheet- C017	#11
9 e	Remove existing concrete ramp and sidewalk as indicated on the plans	SY	10	Refer to drawing and photo on Sheet- C018	#11
	Removal of Guardrails	LF	9	Refer to drawing and photo on Sheet- C018	#11
9 e	Remove existing concrete ramp and sidewalk as indicated on the plans	SY	10	Refer to drawing and photo on Sheet- C018	#11
	New Handrail. Shape and size to match existing	LF	90	Refer to drawing and photo on Sheet- C018A	#11
	Handrail removal	LF	32	Refer to drawing and photo on Sheet- C018	#11
	Removal of existing Guardrail as shown on plans	LF	5	Refer to drawing and photo on Sheet- C018	#11
	Install new Conc Ramp	SY	12	Refer to drawing and photo on Sheet- C018A	#11
	Install new Concrete for sidewalk as indicated in plans	SY	6	Refer to drawing and photo on Sheet- C018A	#11
	Install New Concrete trash pad	SY	1	Refer to drawing and photo on Sheet- C018A	#11
9f	Remove and replace concrete sidewalk as indicated on the plans	SY	10	Refer to drawings on Sheet- C019	#11
	Install New Concrete trash pad	SY	1	Refer to drawings on Sheet- C019	#11
10 b	Grinding of existing concrete surface as indicated on plans	SY	13	Refer to drawings and photo on Sheet- C019	#12
	Install New Concrete trash pad	SY	1	Refer to drawings and photo on Sheet- C019	#12
14/11	Add additional concrete panel as indicated on the drawing	SY	2.5	Refer to drawings and photo on Sheet- C020	#13,#14
12 b	Install new hand rails	LF	12	Refer to drawings on Sheet- C020 and C-025	#13
	Install new ramp	SY	2.5	Refer to drawings on Sheet- C020 and C-025	#13
	Remove and replace existing concrete sidewalk and panel as indicated on the plans	SY	40.5	Refer to drawings on Sheet- C020 and C-025	#13
12 c	Remove and replace existing concrete sidewalk and panel as indicated on the plans	SY	4.5	Refer to drawing and photo on Sheet- C-021	#13
2408 ERATO	Remove existing structures and obstructions as indicated on the plans	LS	1	Refer to drawings and photos on Sheet- C-022	# 4,#6
	Remove existing concrete ramp and sidewalk as indicated on the plans	SY	2.8	Refer to drawings and photos on Sheet- C-022	# 4,#6
	Install New Concrete ramp	SY	6.4	Refer to drawings and photos on Sheet- C-022	# 4,#6
	Install new concrete sidewalk as indicated in drawings.	SY	2.2	Refer to drawings and photos on Sheet- C-022	# 4,#6
	Required New handrails. Shape and size to match existing	LF	32	Refer to drawings and photos on Sheet- C-022	# 4,#6
	Install New Concrete trash pad	SY	1	Refer to drawings and photos on Sheet- C-022	# 4,#6
2414 ERATO	Remove existing structures and obstructions as indicated on the plans	LS	1	Refer to drawings and photos on Sheet- C-022	# 4,#6
	Remove existing concrete sidewalk as indicated on the plans	SY	12	Refer to drawings and photos on Sheet- C-022	# 4,#6
	Install new concrete ramp as indicated in drawings.	SY	12.3	Refer to drawings and photos on Sheet- C-022	# 4,#6
	Install new concrete sidewalk	SY	9.5	Refer to drawings and photos on Sheet- C-022	# 4,#6
	Install New Concrete trash pad	SY	1	Refer to drawings and photos on Sheet- C-022	# 4,#6
	Required New handrails. Shape and size to match existing	LF	52	Refer to drawings and photos on Sheet- C-022	# 4,#6
16	Porch area in front of the main door of the units to be redone as shown on the plans.	SY	136	Refer to drawings on Sheet- C-023, For addresses of the units where this work needs to be performed see NOTE on Sheet-C023.	#15
1213 S LIBERTY ST	Remove and Replace Conc sidewalk as indicated on plans	SY	32.5	Refer to photos and drawings on Sheet- C026	# 4,#6
	Install new concrete sidewalk as indicated on plans	SY	32.5	Refer to photos and drawings on Sheet- C026	# 4,#6
	New Concrete trash pad as indicated on plans	SY	1	Refer to photos and drawings on Sheet- C026	# 4,#6
2400 MAIL CENTRE	Remove existing concrete sidewalk as indicated on the plans	SY	31.5	Refer to drawings on Sheet- C-026	# 4,#6
	Install new concrete ramp as indicated in drawings.	SY	33.5	Refer to drawings on Sheet- C-026	# 4,#6
2210 CLIO ST	Remove existing concrete sidewalk as indicated on the plans	SY	19.6	Refer to drawings on Sheet- C-027	# 4,#6
	Install new concrete ramp as indicated in drawings.	SY	19.6	Refer to drawings on Sheet- C-027	# 4,#6
1220 RJR WAY	Install new Concrete trash pad	SY	1	Refer to photos and drawings on Sheet- C027	# 4,#6

REVISIONS	BY

**ECM Consultants, Inc.**  
 ARCHITECT/ENGINEER: ENGINEERS - ARCHITECTS - CONSTRUCTION MANAGERS  
 1301 CLEARVIEW PKWY. SUITE 200  
 METAIRIE, LOUISIANA 70001  
 PHONE: (504) 885-4080. FAX: (504) 885-1439  
 EMAIL: mail@ecmconsultants.com

**HOUSING AUTHORITY OF NEW ORLEANS**  
 2051 SENATE ST. BUILDING B. RM. 202  
 NEW ORLEANS, LOUISIANA 70122

**SCOPE OF WORK SUMMARY**

DRAWN  
 M.L.M. & A.E.D.  
 CHECKED  
 N.G.W.  
 DATE  
 JUN. 21, 2024  
 SCALE  
 AS SHOWN  
 JOB NO.  
 22462.14  
 SHEET NO.

G-003



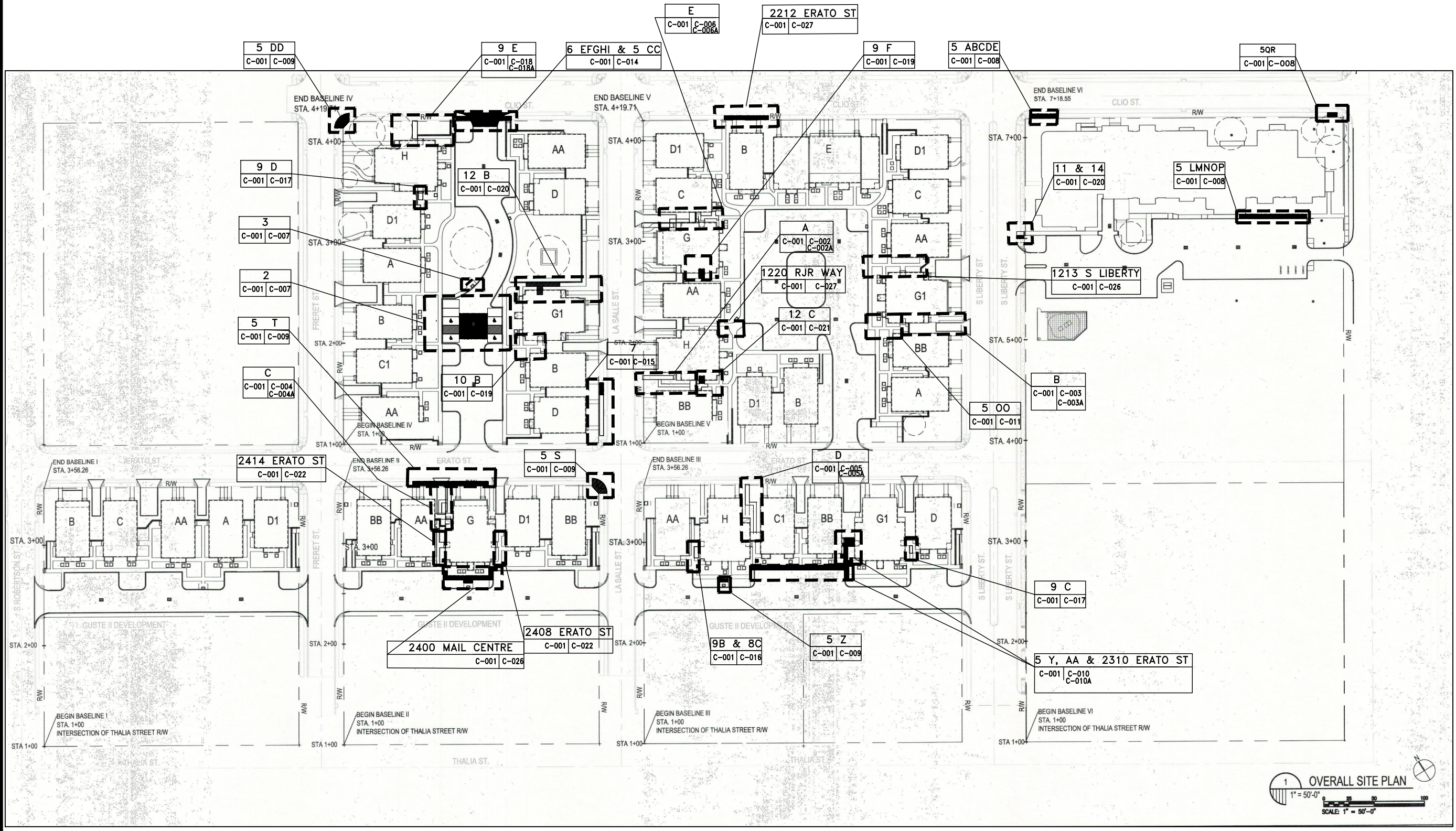



1 OVERALL SITE PLAN  
 1" = 50'-0"  
 SCALE: 1" = 50'-0"

NOTE:  
 THIS IS TYPICAL LEGEND FOR ALL CIVIL SHEETS.

**LEGEND**

-  REMOVAL OF CONCRETE
-  NEW CONCRETE

REVISIONS	BY

ARCHITECT/ENGINEER:  
**ECM Consultants, Inc.**  
 ENGINEERS - ARCHITECTS - CONSTRUCTION MANAGERS  
 1301 CLEARVIEW PKWY. SUITE 200  
 METAIRIE, LOUISIANA 70001  
 PHONE: (504) 885-4080, FAX: (504) 885-1439  
 EMAIL: mail@ecmconsultants.com

OWNER:  
**HOUSING AUTHORITY OF NEW ORLEANS**  
 2051 SENATE ST. BUILDING B, RM. 202  
 NEW ORLEANS, LOUISIANA 70122

PROJECT:  
**GUSTE III COMMUNITY INTERIOR & EXTERIOR REPAIRS**  
 SHEET TITLE:  
**OVERALL SITE PLAN**

DRAWN	K.A.
CHECKED	N.G.W.
DATE	JUN. 21, 2024
SCALE	AS SHOWN
JOB NO.	22462.14
SHEET NO.	C-001

C-001



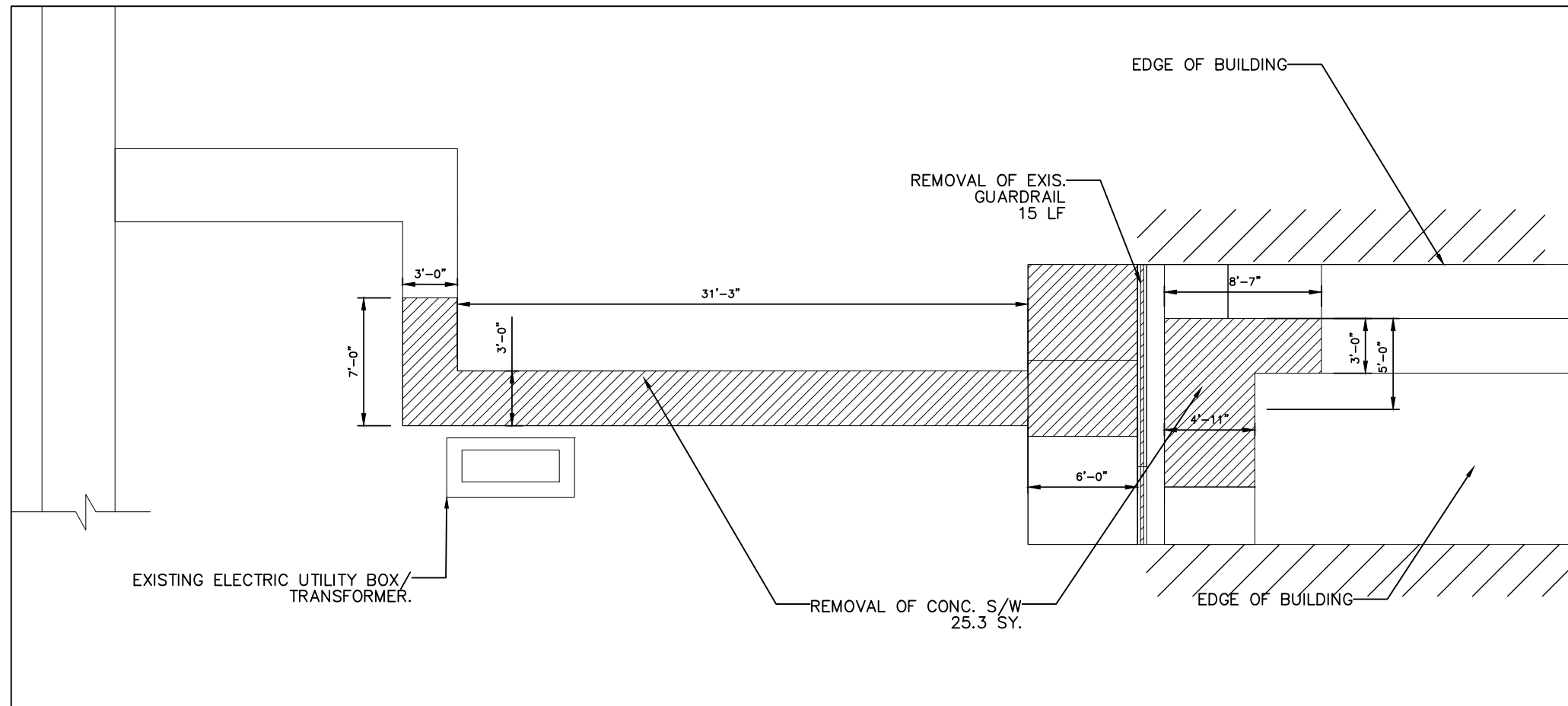

1 & 4 1226 RJR WAY A  
 SCALE: 1/4" = 1'-0" C-001 | C-002

REMOVE EXISTING GUARDRAILS 15 LF. NEW GUARDRAILS TO BE INSTALLED TO MATCH THE SHAPE & SIZE OF EXISTING. SEE SHEET C-024 FOR DETAILS.

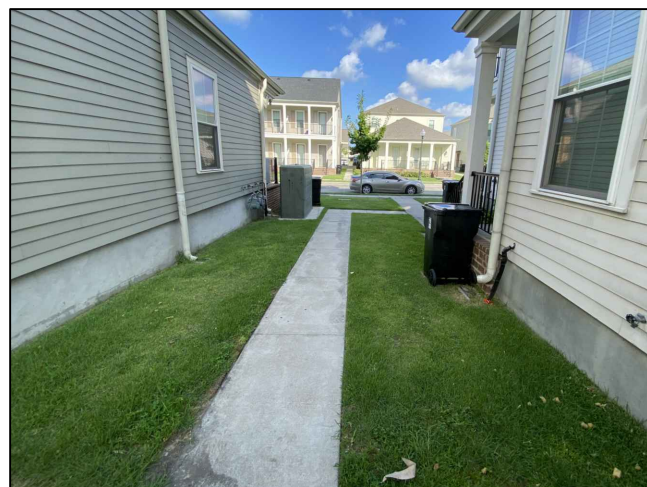

1 & 4 1224 RJR WAY  
 SCALE: N.T.S

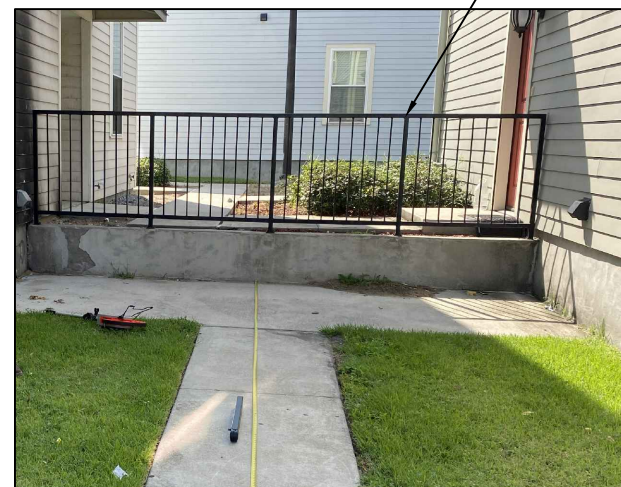

1 & 4 1224 RJR WAY  
 SCALE: N.T.S

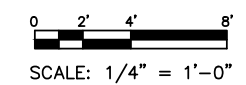

REVISIONS	BY

ARCHITECT/ENGINEER:  
**ECM Consultants, Inc.**  
 ENGINEERS - ARCHITECTS - CONSTRUCTION MANAGERS  
 1301 CLEARVIEW PKWY. SUITE 200  
 METAIRIE, LOUISIANA 70001  
 PHONE: (504) 885-4080. FAX: (504) 885-1439  
 EMAIL: mail@ecmconsultants.com

OWNER:  
 HOUSING AUTHORITY  
 OF NEW ORLEANS  
 2051 SENATE ST. BUILDING B, RM. 202  
 NEW ORLEANS, LOUISIANA 70122

PROJECT:  
 GUSTE III COMMUNITY  
 INTERIOR & EXTERIOR REPAIRS  
 SHEET TITLE:  
 ACCESSIBLE ROUTES IMPROVEMENTS

DRAWN K.A.
CHECKED N.G.W.
DATE JUN. 21, 2024
SCALE AS SHOWN
JOB NO. 22462.14
SHEET NO.

C-002

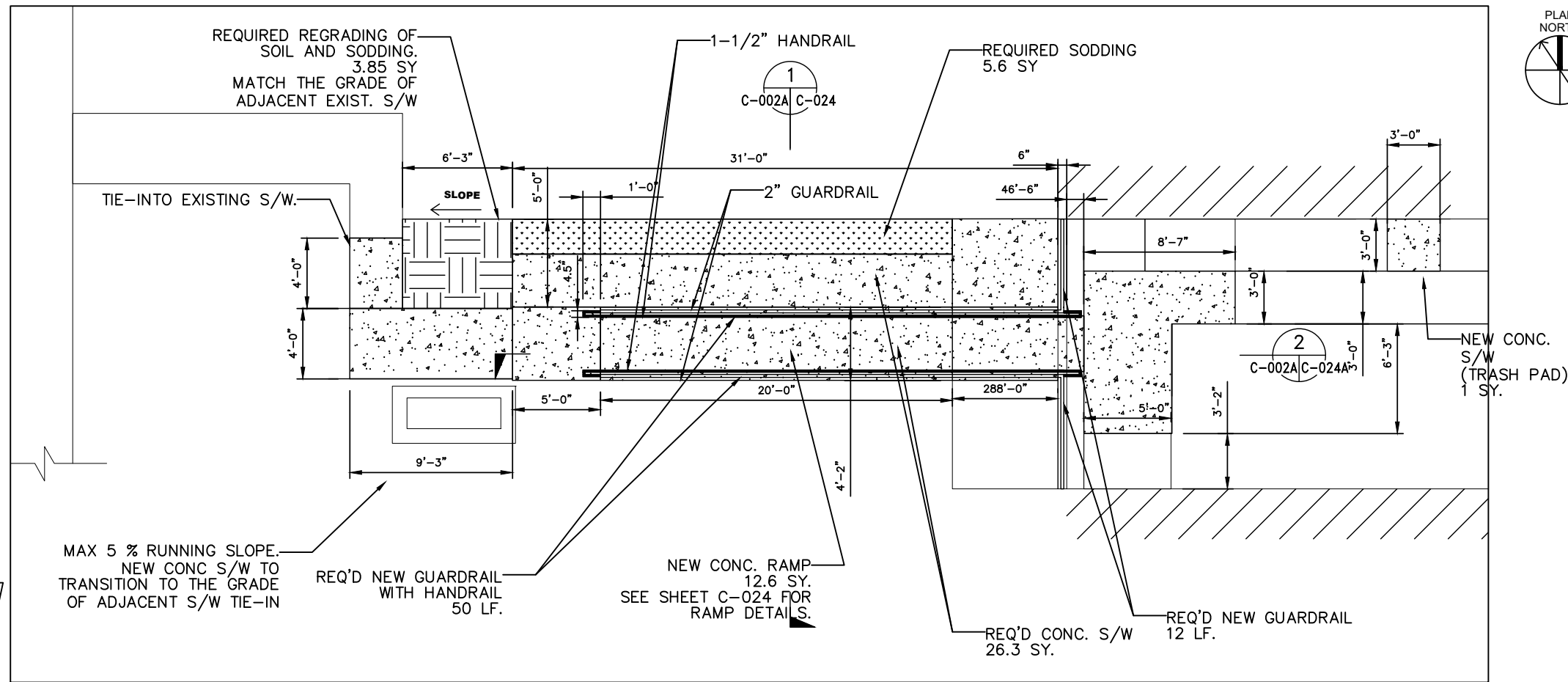

REMOVE EXISTING GUARDRAILS 12 LF. NEW GUARDRAILS TO BE INSTALLED TO MATCH THE SHAPE & SIZE OF EXISTING. SEE SHEET C-024 FOR DETAILS.

MAX 5% RUNNING SLOPE. NEW CONC S/W TO TRANSITION TO THE GRADE OF ADJACENT S/W TIE-IN

REQ'D NEW GUARDRAIL WITH HANDRAIL 50 LF.

NEW CONC. RAMP 12.6 SY. SEE SHEET C-024 FOR RAMP DETAILS.

REQ'D CONC. S/W 26.3 SY.

REQ'D NEW GUARDRAIL 12 LF.

NEW CONC. S/W (TRASH PAD) 1 SY.

1 & 4 1226 RJR WAY A  
SCALE: 1/4" = 1'-0" C-001 | C-002

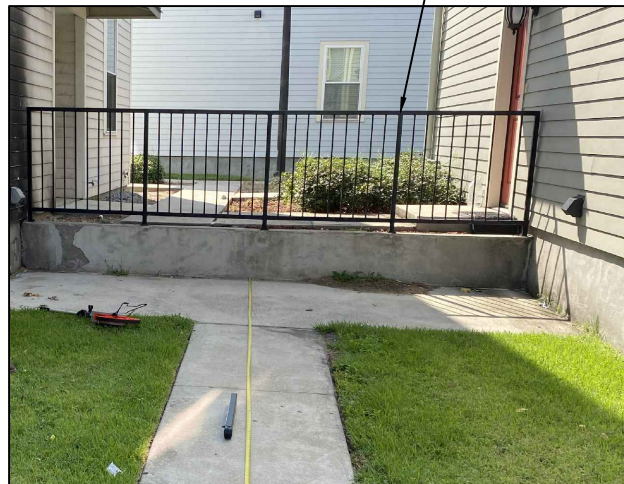

1 & 4 1224 RJR WAY  
SCALE: N.T.S

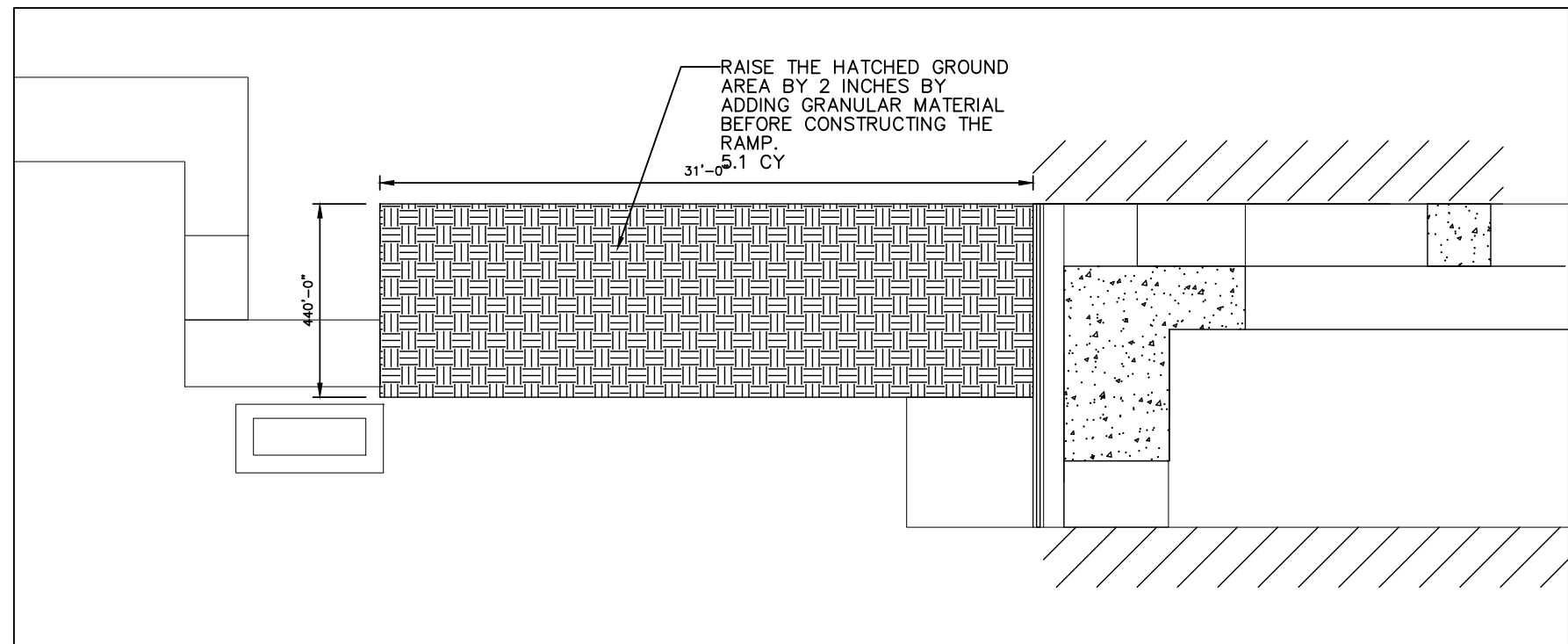

1 & 4 1226 RJR WAY A  
SCALE: 1/4" = 1'-0" C-001 | C-002

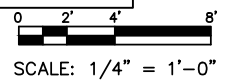

REVISIONS	BY

ARCHITECT/ENGINEER:  
**ECM Consultants, Inc.**  
ENGINEERS - ARCHITECTS - CONSTRUCTION MANAGERS  
1301 CLEARVIEW PKWY. SUITE 200  
METAIRIE, LOUISIANA 70001  
PHONE: (504) 885-4080. FAX: (504) 885-1439  
EMAIL: mail@ecmconsultants.com

OWNER:  
HOUSING AUTHORITY  
OF NEW ORLEANS  
2051 SENATE ST. BUILDING B, RM. 202  
NEW ORLEANS, LOUISIANA 70122

PROJECT:  
GUSTE III COMMUNITY  
INTERIOR & EXTERIOR REPAIRS  
SHEET TITLE:  
ACCESSIBLE ROUTES IMPROVEMENTS

DRAWN	K.A.
CHECKED	N.G.W.
DATE	JUN. 21, 2024
SCALE	AS SHOWN
JOB NO.	22462.14
SHEET NO.	

C-002A





5 00  
C-003 C-011

EXISTING ELECTRIC UTILITY BOX/  
TRANSFORMER.

REMOVAL OF CONC. S/W.  
12.5 SY.

REMOVAL OF EXIST. GUARDRAIL  
17 LF

1 & 4 1219 S LIBERTY **B**

SCALE: 1/4" = 1'-0" C-001 C-003

REMOVE EXISTING GUARDRAILS 17 LF.  
NEW GUARDRAILS TO BE INSTALLED TO  
MATCH THE SHAPE & SIZE OF EXISTING.  
SEE SHEET C-024 FOR DETAILS.

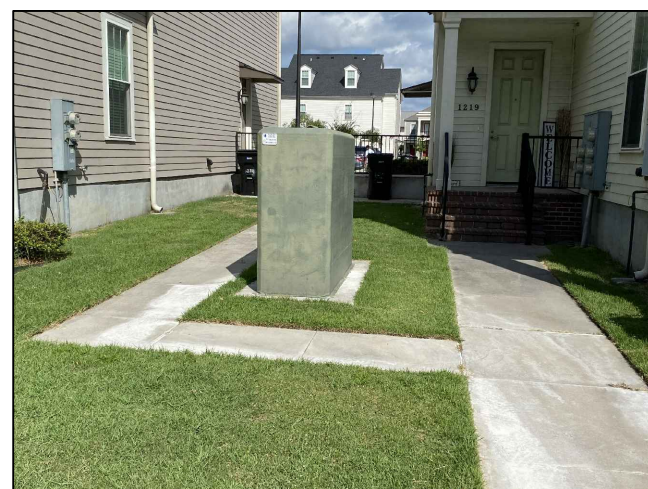

1 & 4 1217 S LIBERTY

SCALE: N.T.S

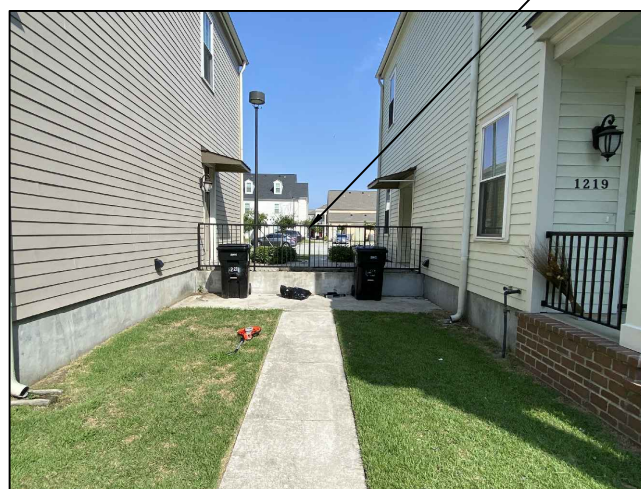

1 & 4 1217 S LIBERTY

SCALE: N.T.S

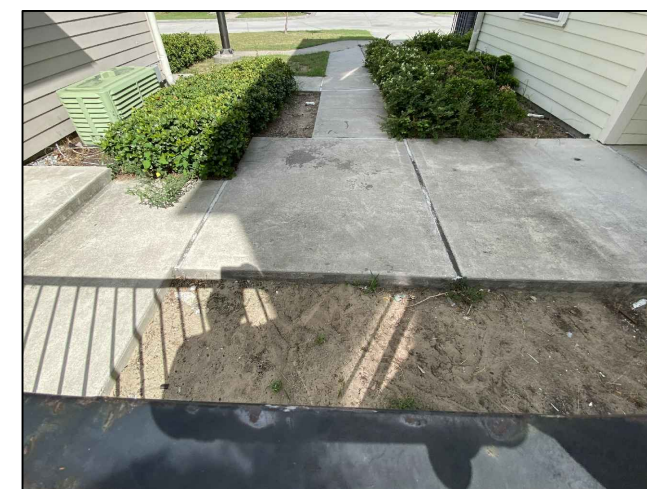

1 & 4 1217 S LIBERTY

SCALE: N.T.S

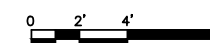

SCALE: 1/4" = 1'-0"

REVISIONS	BY

ARCHITECT/ENGINEER:  
**ECM Consultants, Inc.**  
 ENGINEERS - ARCHITECTS - CONSTRUCTION MANAGERS  
 1301 CLEARVIEW PKWY. SUITE 200  
 METAIRIE, LOUISIANA 70001  
 PHONE: (504) 885-4080. FAX: (504) 885-1439  
 EMAIL: mail@ecmconsultants.com

OWNER:  
 HOUSING AUTHORITY  
 OF NEW ORLEANS  
 2051 SENATE ST. BUILDING B, RM. 202  
 NEW ORLEANS, LOUISIANA 70122

PROJECT:  
 GUSTE III COMMUNITY  
 INTERIOR & EXTERIOR REPAIRS  
 SHEET TITLE:  
 ACCESSIBLE ROUTES IMPROVEMENTS

DRAWN K.A.
CHECKED N.G.W.
DATE JUN. 21, 2024
SCALE AS SHOWN
JOB NO. 22462.14
SHEET NO.

C-003

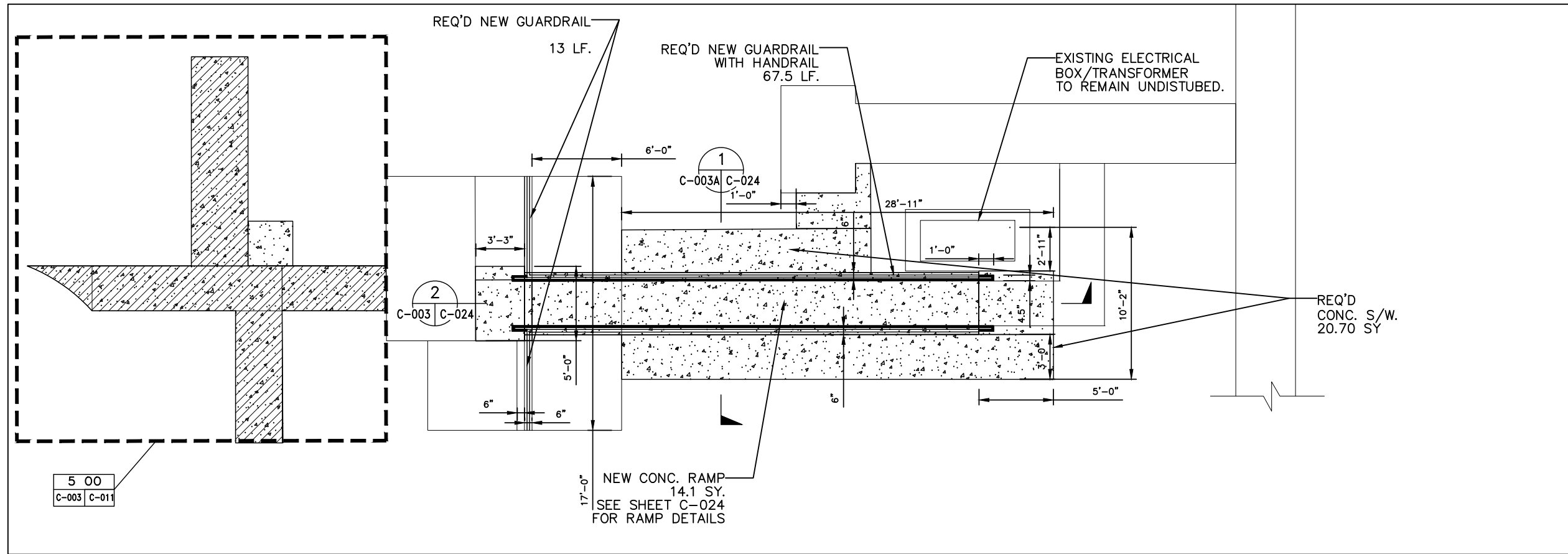

1 & 4 1219 S LIBERTY B  
 SCALE: 1/4" = 1'-0" C-001 C-003

REMOVE EXISTING GUARDRAILS 17 LF.  
 NEW GUARDRAILS TO BE INSTALLED TO  
 MATCH THE SHAPE & SIZE OF EXISTING.  
 SEE SHEET C-024 FOR DETAILS.



1 & 4 1217 S LIBERTY  
 SCALE: N.T.S

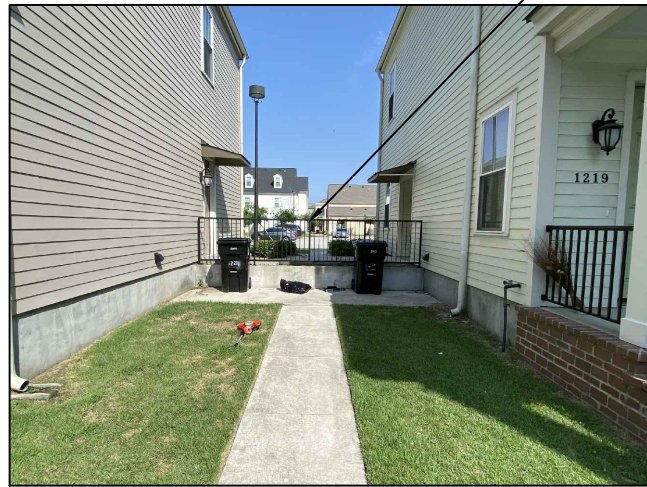

1 & 4 1217 S LIBERTY  
 SCALE: N.T.S



1 & 4 1217 S LIBERTY  
 SCALE: N.T.S

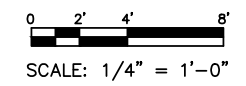

REVISIONS	BY

ARCHITECT/ENGINEER:  
**ECM Consultants, Inc.**  
 ENGINEERS - ARCHITECTS - CONSTRUCTION MANAGERS  
 1301 CLEARVIEW PKWY. SUITE 200  
 METAIRIE, LOUISIANA 70001  
 PHONE: (504) 885-4080. FAX: (504) 885-1439  
 EMAIL: mail@ecmconsultants.com

OWNER:  
 HOUSING AUTHORITY  
 OF NEW ORLEANS  
 2051 SENATE ST. BUILDING B, RM. 202  
 NEW ORLEANS, LOUISIANA 70122

PROJECT:  
 GUSTE III COMMUNITY  
 INTERIOR & EXTERIOR REPAIRS  
 SHEET TITLE:  
 ACCESSIBLE ROUTES IMPROVEMENTS

DRAWN	K.A.
CHECKED	N.G.W.
DATE	JUN. 21, 2024
SCALE	AS SHOWN
JOB NO.	22462.14
SHEET NO.	

C-003A



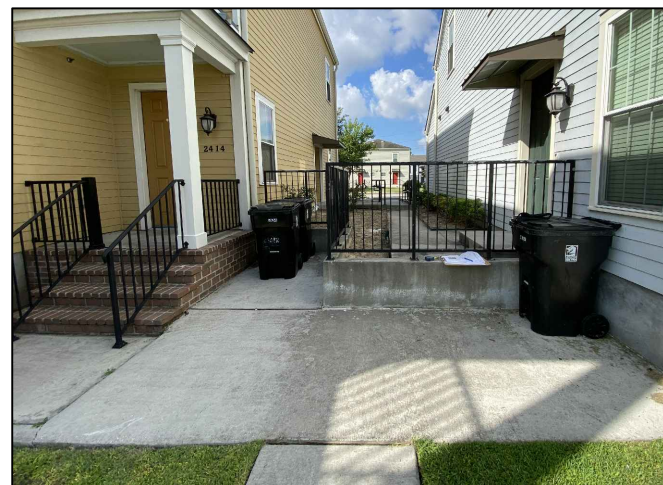

1 & 4 2414 ERATO ST  
SCALE: N.T.S

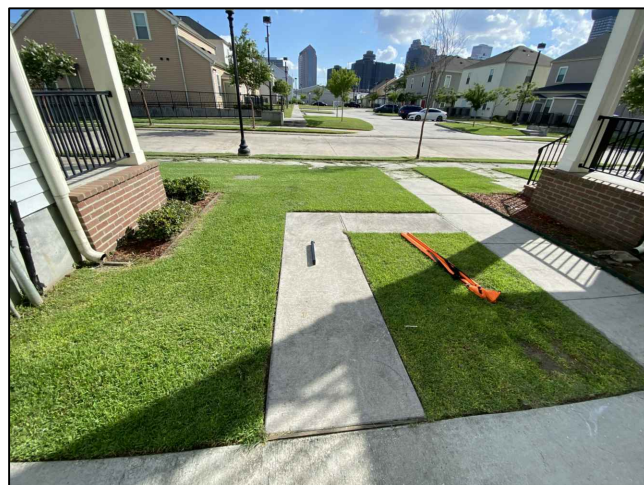

1 & 4 2414 ERATO ST  
SCALE: N.T.S

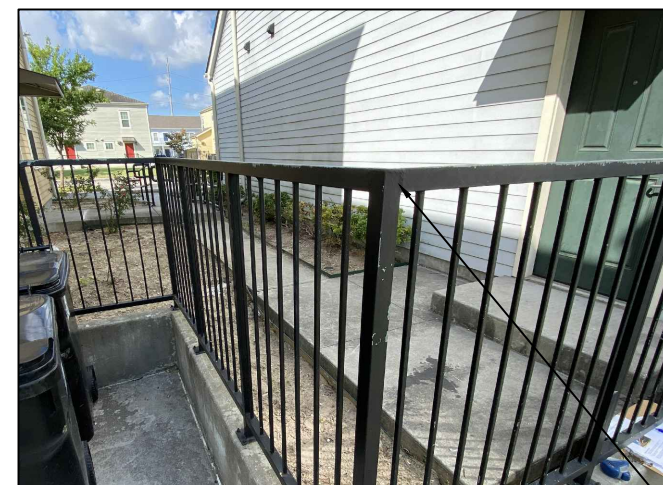

1 & 4 2414 ERATO ST  
SCALE: N.T.S

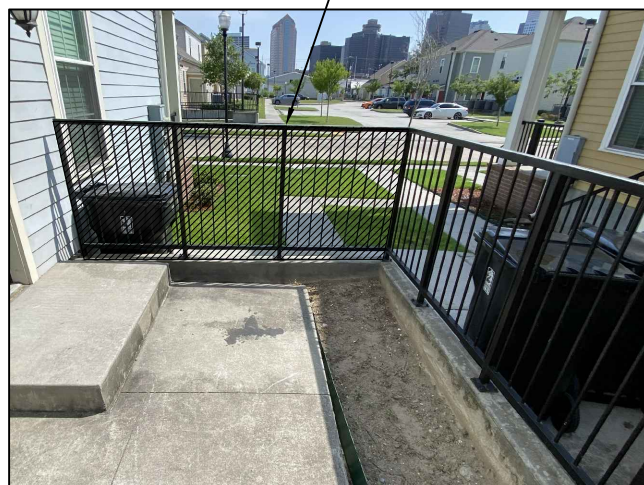

1 & 4 2414 ERATO ST  
SCALE: N.T.S

REMOVE EXISTING GUARDRAILS 9.5 LF.  
NEW GUARDRAILS TO BE INSTALLED TO  
MATCH THE SHAPE & SIZE OF EXISTING.  
SEE SHEET C-024 FOR DETAILS.

CUT EXISTING GUARDRAIL HERE. HATCHED GUARDRAIL  
TO BE REMOVED AND REPLACED. SHAPE & SIZE TO  
MATCH EXISTING. SEE SHEET C-004 FOR DETAILS.

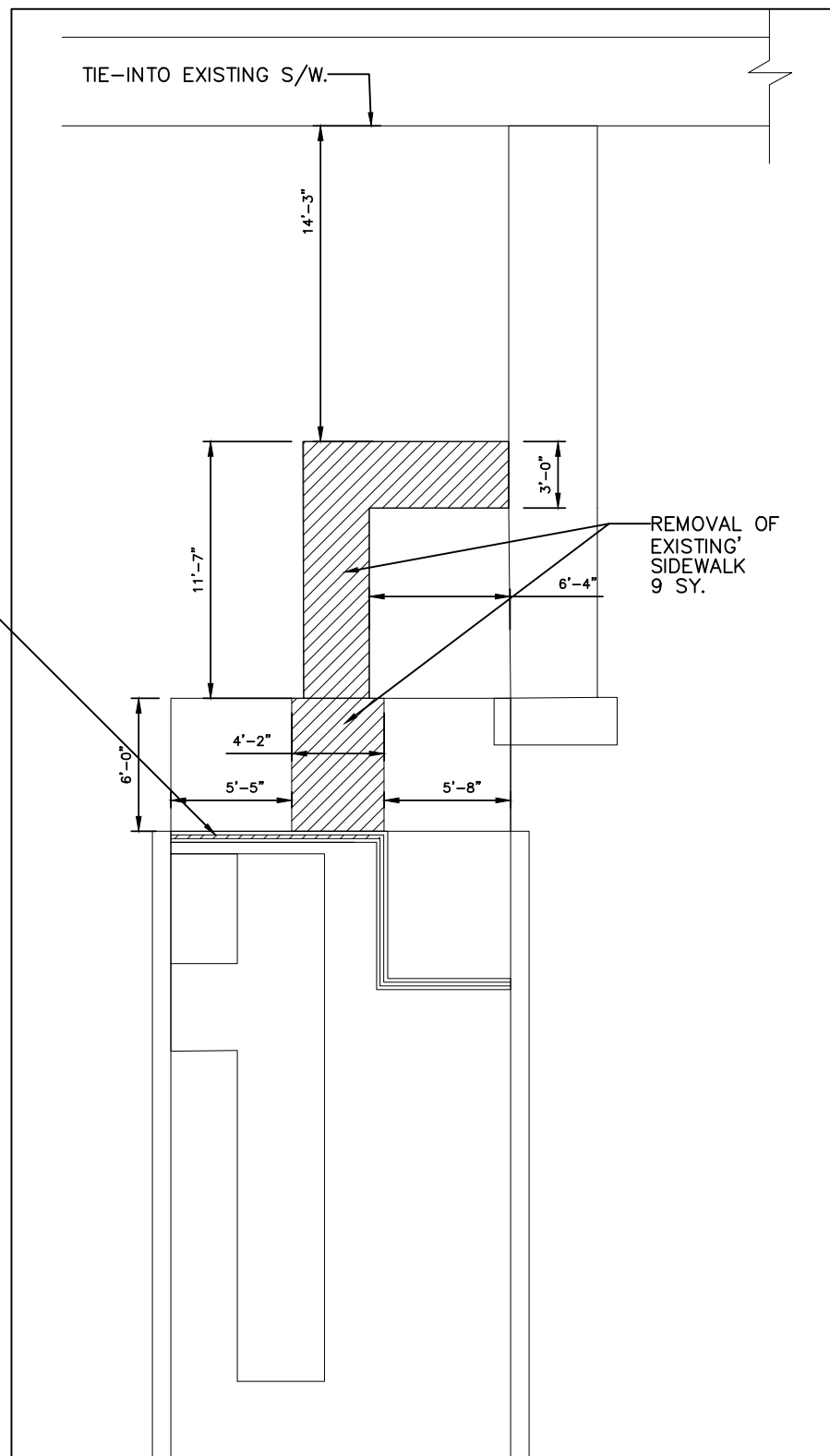

1 & 4 2414 ERATO ST C  
SCALE: 1/4" = 1'-0" C-001 | C-004

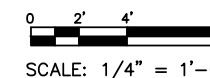

REVISIONS	BY

ARCHITECT/ENGINEER:  
**ECM Consultants, Inc.**  
 ENGINEERS - ARCHITECTS - CONSTRUCTION MANAGERS  
 1301 CLEARVIEW PKWY. SUITE 200  
 METAIRIE, LOUISIANA 70001  
 PHONE: (504) 885-4080, FAX: (504) 885-1439  
 EMAIL: mail@ecmconsultants.com

OWNER:  
 HOUSING AUTHORITY  
 OF NEW ORLEANS  
 2051 SENATE ST. BUILDING B, RM. 202  
 NEW ORLEANS, LOUISIANA 70122

PROJECT:  
 GUSTE III COMMUNITY  
 INTERIOR & EXTERIOR REPAIRS  
 SHEET TITLE:  
 ACCESSIBLE ROUTES IMPROVEMENTS

DRAWN K.A.
CHECKED N.G.W.
DATE JUN. 21, 2024
SCALE AS SHOWN
JOB NO. 22462.14
SHEET NO.

C-004



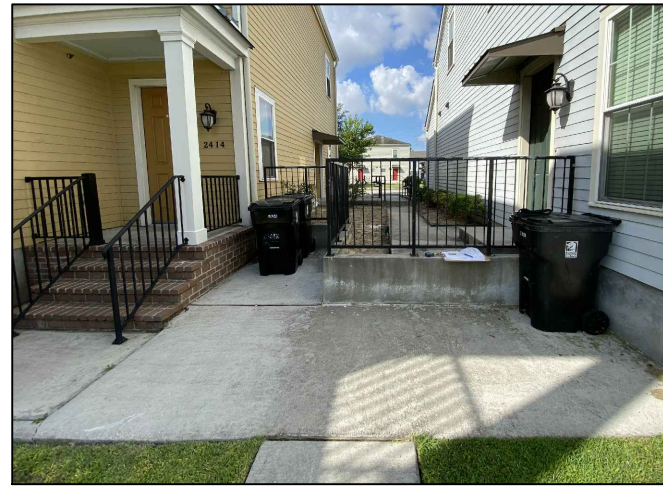

1 & 4 2414 ERATO ST  
SCALE: N.T.S

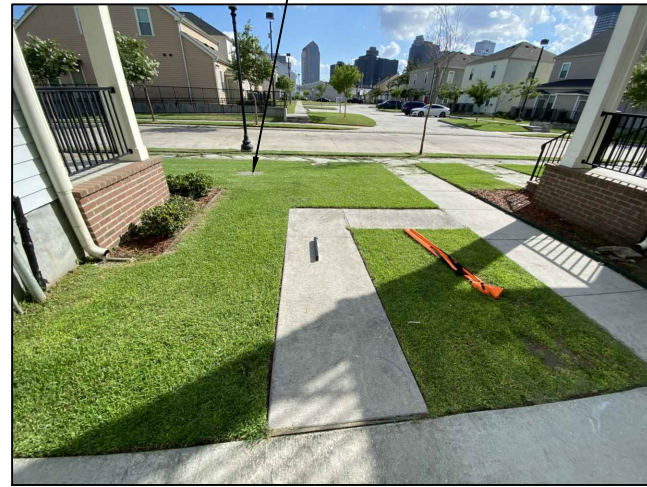

1 & 4 2414 ERATO ST  
SCALE: N.T.S

UTILITY BOX TO BE ADJUSTED (BY OTHERS)

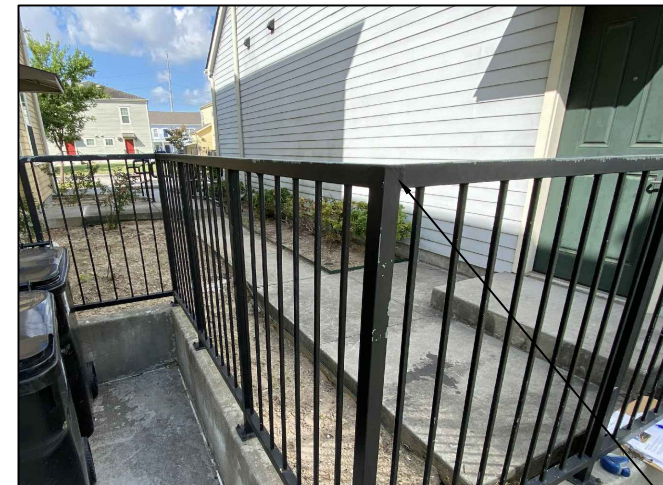

1 & 4 2414 ERATO ST  
SCALE: N.T.S

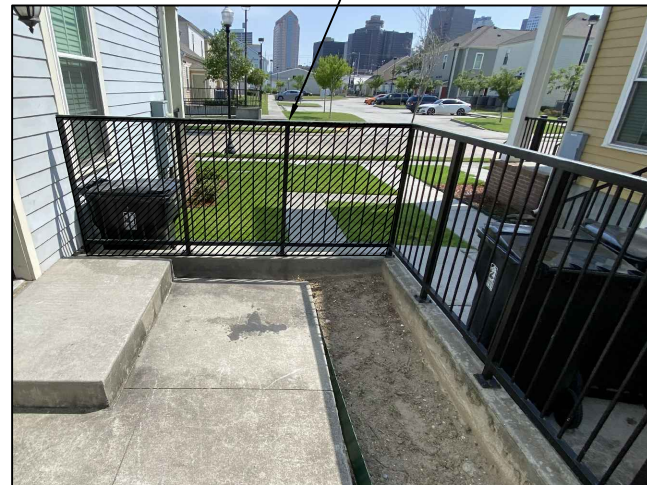

1 & 4 2414 ERATO ST  
SCALE: N.T.S

CUT EXISTING GUARDRAIL HERE. HATCHED GUARDRAIL TO BE REMOVED AND REPLACED. SHAPE & SIZE TO MATCH EXISTING. SEE SHEET C-004A FOR DETAILS.

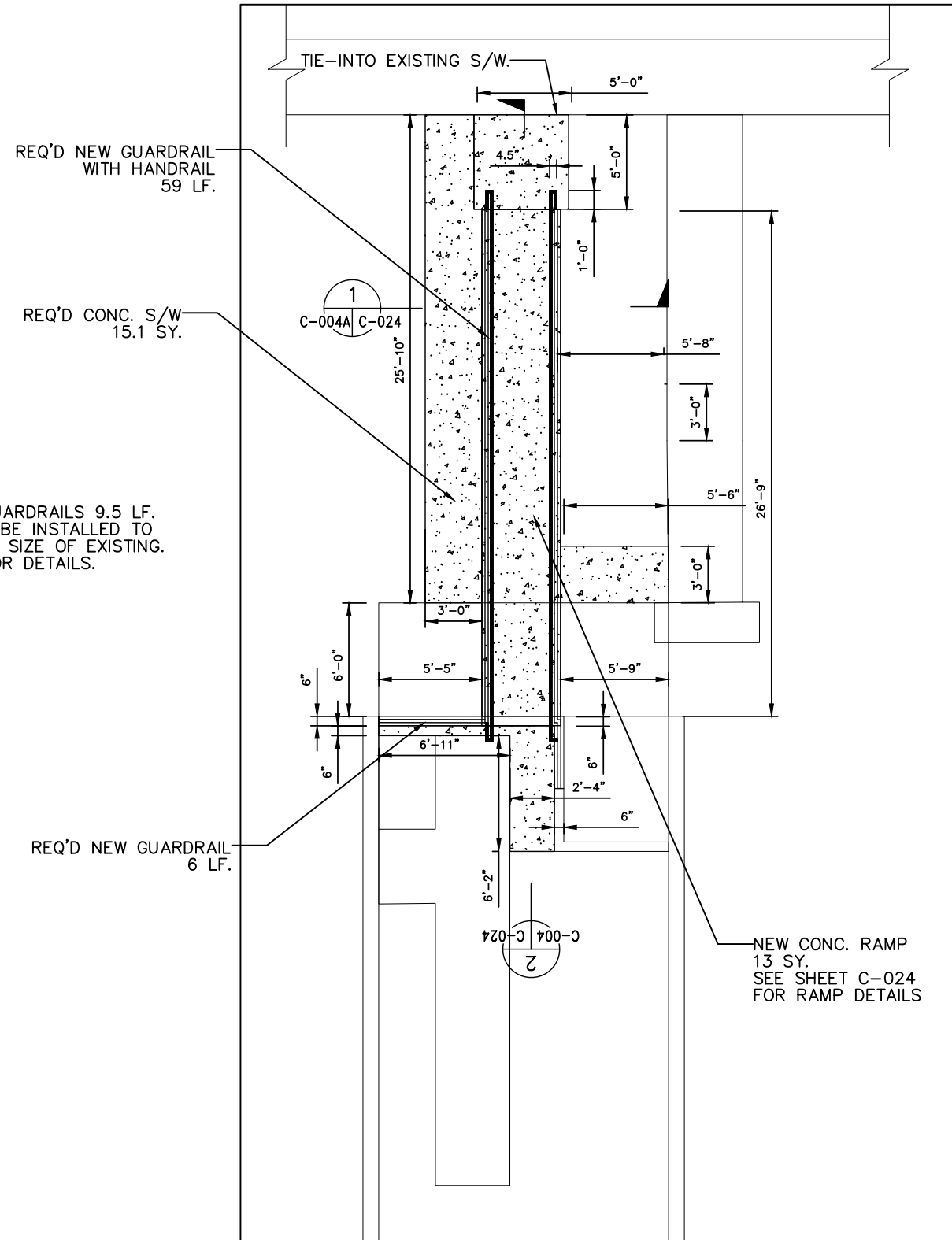

1 & 4 2414 ERATO ST C  
SCALE: 1/4" = 1'-0" C-001 C-004

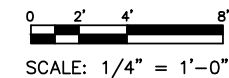

REVISIONS	BY

ARCHITECT/ENGINEER:  
**ECM Consultants, Inc.**  
ENGINEERS - ARCHITECTS - CONSTRUCTION MANAGERS  
1301 CLEARVIEW PKWY. SUITE 200  
METAIRIE, LOUISIANA 70001  
PHONE: (504) 885-4080. FAX: (504) 885-1439  
EMAIL: mail@ecmconsultants.com

OWNER:  
HOUSING AUTHORITY  
OF NEW ORLEANS  
2051 SENATE ST. BUILDING B, RM. 202  
NEW ORLEANS, LOUISIANA 70122

PROJECT:  
GUSTE III COMMUNITY  
INTERIOR & EXTERIOR REPAIRS  
SHEET TITLE:  
ACCESSIBLE ROUTES IMPROVEMENTS

DRAWN	K.A.
CHECKED	N.G.W.
DATE	JUN. 21, 2024
SCALE	AS SHOWN
JOB NO.	22462.14
SHEET NO.	

C-004A







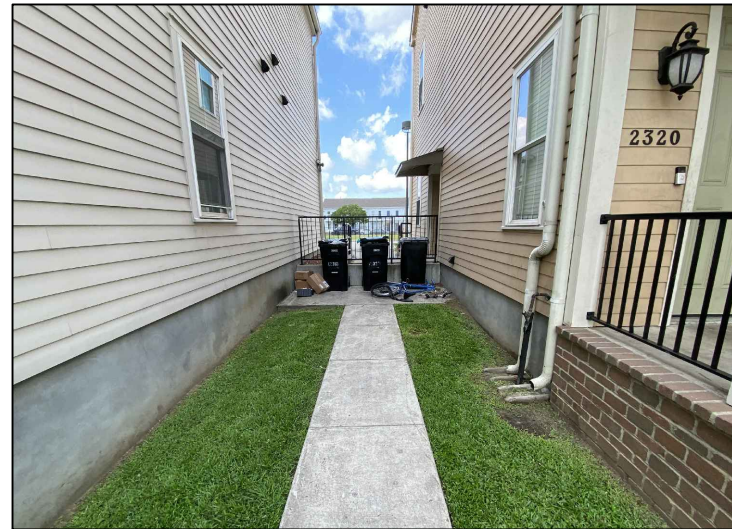

1 & 4 2320 ERATO ST  
SCALE: N.T.S

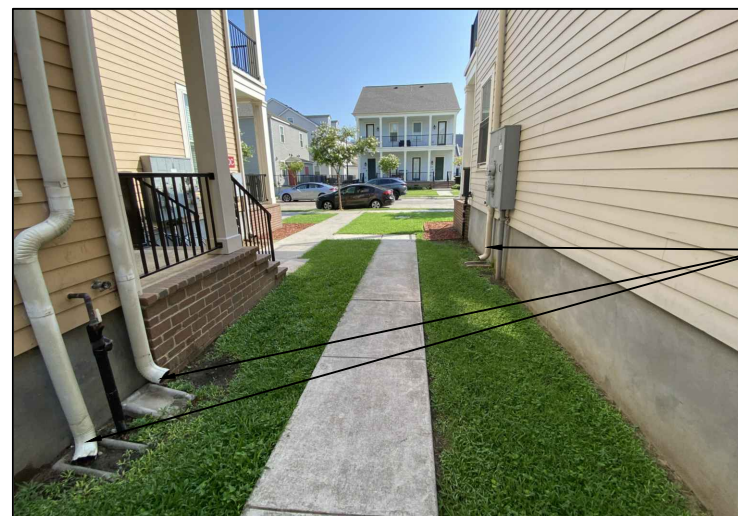

1 & 4 2320 ERATO ST  
SCALE: N.T.S

DRAINS TO BE ADJUSTED SO AS TO DRAIN THE WATER ON TO THE NEW S/W TO BE INSTALLED.

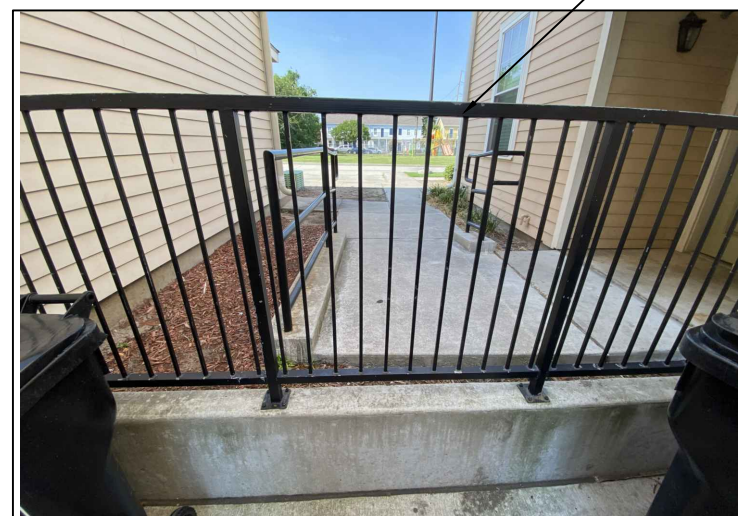

1 & 4 2320 ERATO ST  
SCALE: N.T.S

REMOVE EXISTING GUARDRAILS 11.5 LF. NEW GUARDRAILS TO BE INSTALLED TO MATCH THE SHAPE & SIZE OF EXISTING. SEE SHEET C-024 FOR DETAILS.

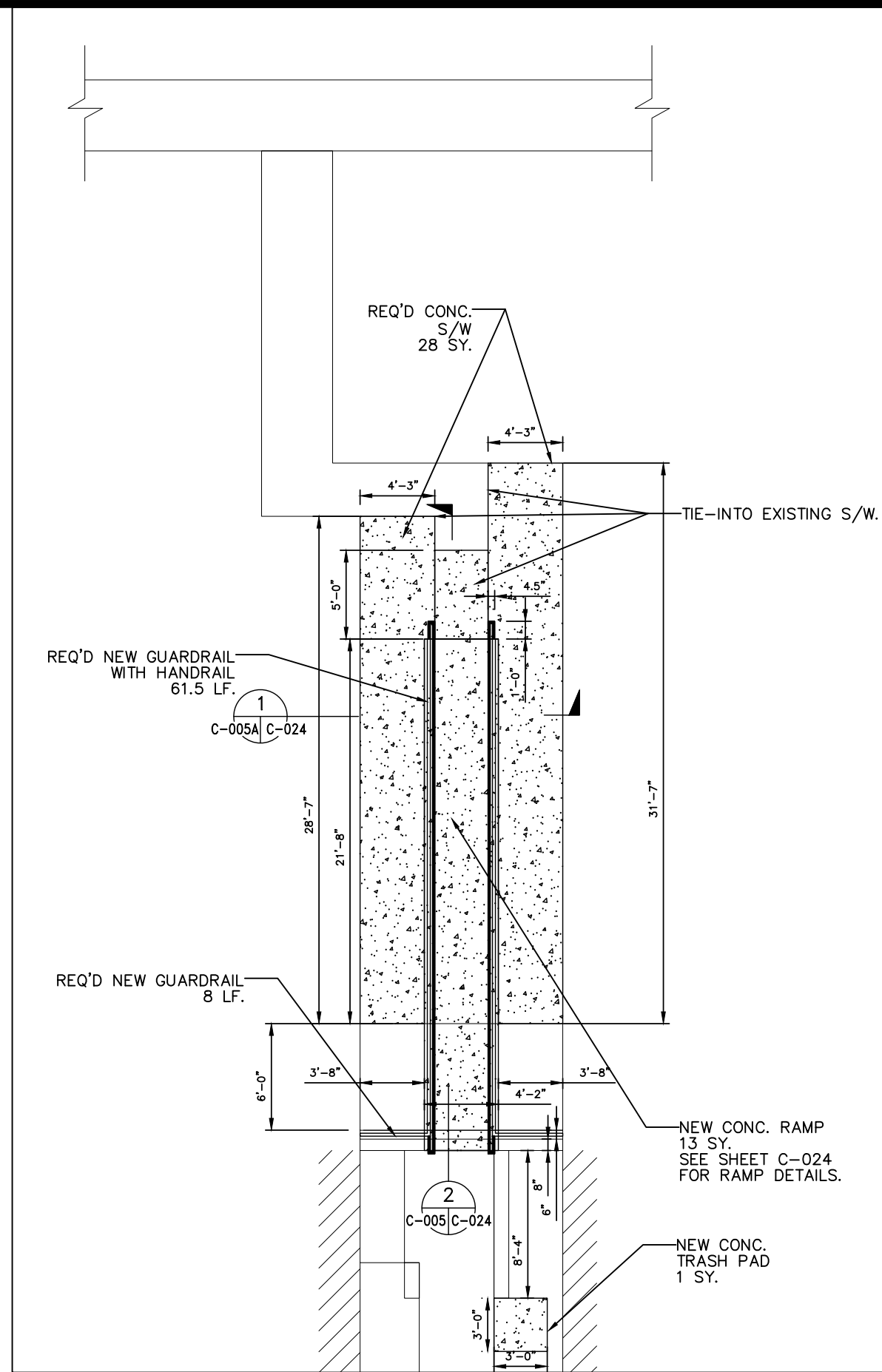

1 & 4 2320 ERATO ST  
SCALE: 1/4" = 1'-0" C-001 C-005

SCALE: 1/4" = 1'-0"



REVISIONS	BY

ARCHITECT/ENGINEER:  
**ECM Consultants, Inc.**  
ENGINEERS - ARCHITECTS - CONSTRUCTION MANAGERS  
1301 CLEARVIEW PKWY. SUITE 200  
METAIRIE, LOUISIANA 70001  
PHONE: (504) 885-4080, FAX: (504) 885-1439  
EMAIL: mail@ecmconsultants.com

OWNER:  
HOUSING AUTHORITY  
OF NEW ORLEANS  
2051 SENATE ST. BUILDING B, RM. 202  
NEW ORLEANS, LOUISIANA 70122

PROJECT:  
GUSTE III COMMUNITY  
INTERIOR & EXTERIOR REPAIRS  
SHEET TITLE:  
ACCESSIBLE ROUTES IMPROVEMENTS

DRAWN	K.A.
CHECKED	N.G.W.
DATE	JUN. 21, 2024
SCALE	AS SHOWN
JOB NO.	22462.14
SHEET NO.	

C-005A



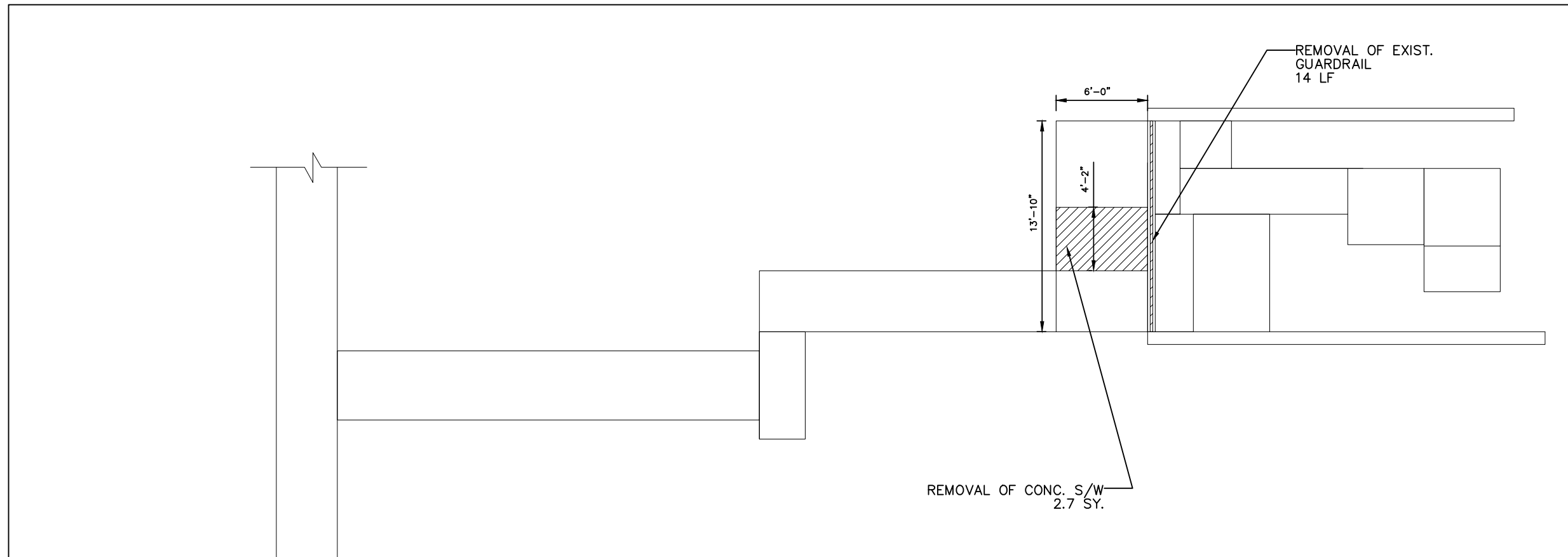

1 & 4 1208 RJR WAY E  
 SCALE: 1/4" = 1'-0" C-001 | C-006

REMOVE EXISTING GUARDRAILS 14 LF.  
 NEW GUARDRAILS TO BE INSTALLED TO  
 MATCH THE SHAPE & SIZE OF EXISTING.  
 SEE SHEET C-024 FOR DETAILS.

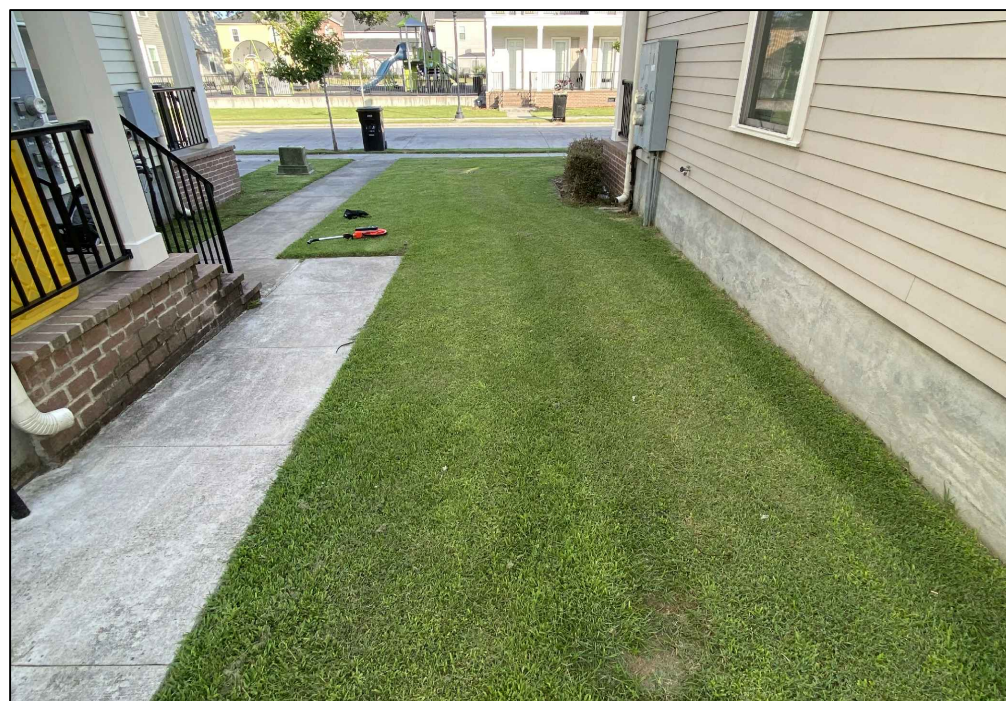

1 & 4 1208 RJR WAY  
 SCALE: N.T.S

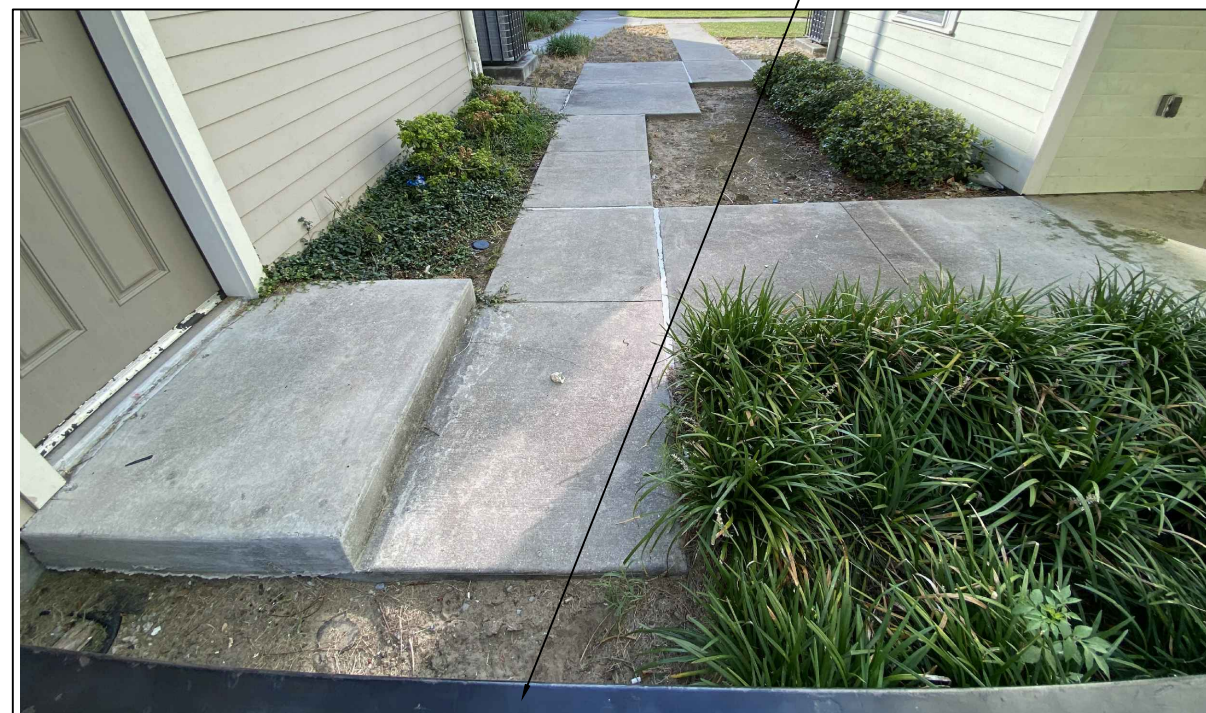

1 & 4 1208 RJR WAY  
 SCALE: N.T.S



SCALE: 1/4" = 1'-0"

REVISIONS	BY

ARCHITECT/ENGINEER:  
**ECM Consultants, Inc.**  
 ENGINEERS - ARCHITECTS - CONSTRUCTION MANAGERS  
 1301 CLEARVIEW PKWY. SUITE 200  
 METAIRIE, LOUISIANA 70001  
 PHONE: (504) 885-4080. FAX: (504) 885-1439  
 EMAIL: mail@ecmconsultants.com

OWNER:  
 HOUSING AUTHORITY  
 OF NEW ORLEANS  
 2051 SENATE ST. BUILDING B, RM. 202  
 NEW ORLEANS, LOUISIANA 70122

PROJECT:  
 GUSTE III COMMUNITY  
 INTERIOR & EXTERIOR REPAIRS  
 SHEET TITLE:  
 ACCESSIBLE ROUTES IMPROVEMENTS

DRAWN	K.A.
CHECKED	N.G.W.
DATE	JUN. 21, 2024
SCALE	AS SHOWN
JOB NO.	22462.14
SHEET NO.	C-006

C-006



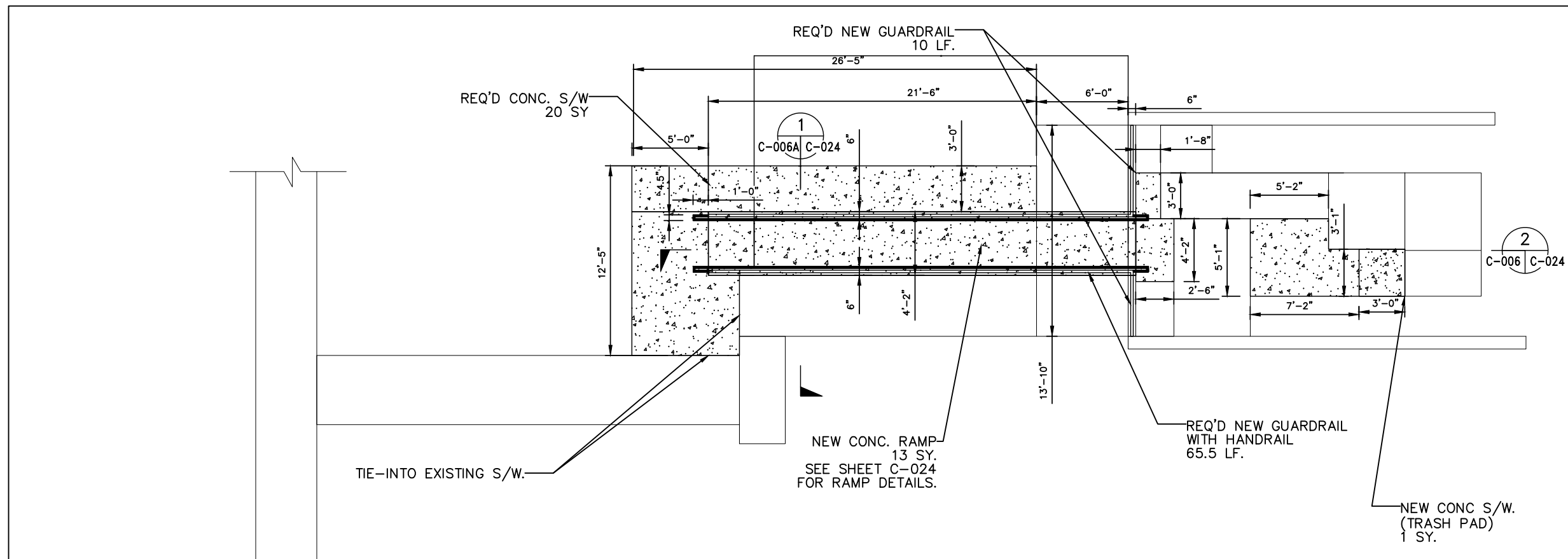

1 & 4 1208 RJR WAY E  
 SCALE: 1/4" = 1'-0" C-001 | C-006

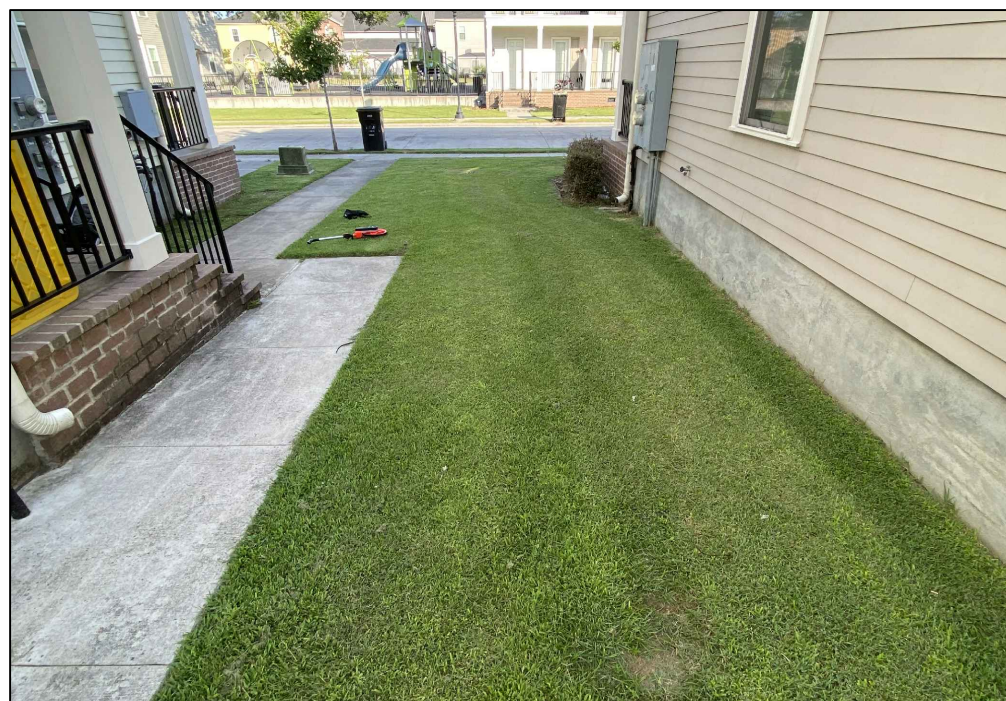

1 & 4 1208 RJR WAY  
 SCALE: N.T.S

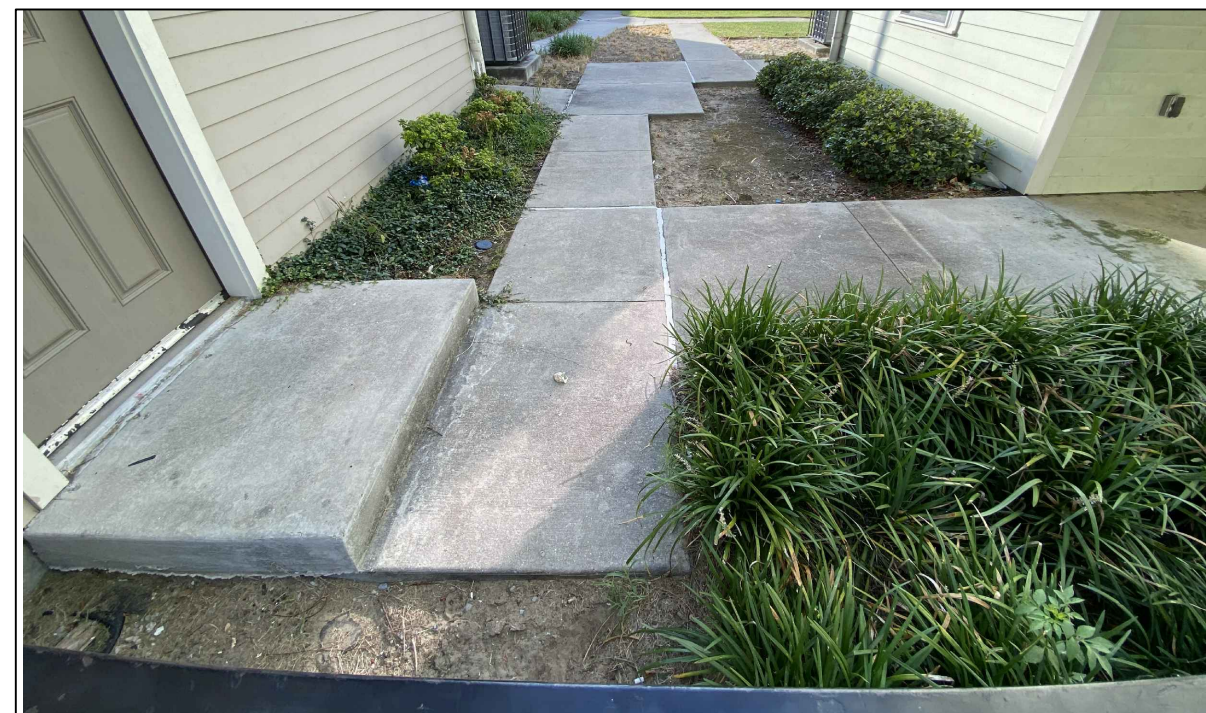

1 & 4 1208 RJR WAY  
 SCALE: N.T.S



REVISIONS	BY

ARCHITECT/ENGINEER:  
**ECM Consultants, Inc.**  
 ENGINEERS - ARCHITECTS - CONSTRUCTION MANAGERS  
 1301 CLEARVIEW PKWY. SUITE 200  
 METAIRIE, LOUISIANA 70001  
 PHONE: (504) 885-4080. FAX: (504) 885-1439  
 EMAIL: mail@ecmconsultants.com

OWNER:  
 HOUSING AUTHORITY  
 OF NEW ORLEANS  
 2051 SENATE ST. BUILDING B, RM. 202  
 NEW ORLEANS, LOUISIANA 70122

PROJECT:  
 GUSTE III COMMUNITY  
 INTERIOR & EXTERIOR REPAIRS  
 SHEET TITLE:  
 ACCESSIBLE ROUTES IMPROVEMENTS

DRAWN	K.A.
CHECKED	N.G.W.
DATE	JUN. 21, 2024
SCALE	AS SHOWN
JOB NO.	22462.14
SHEET NO.	

C-006A



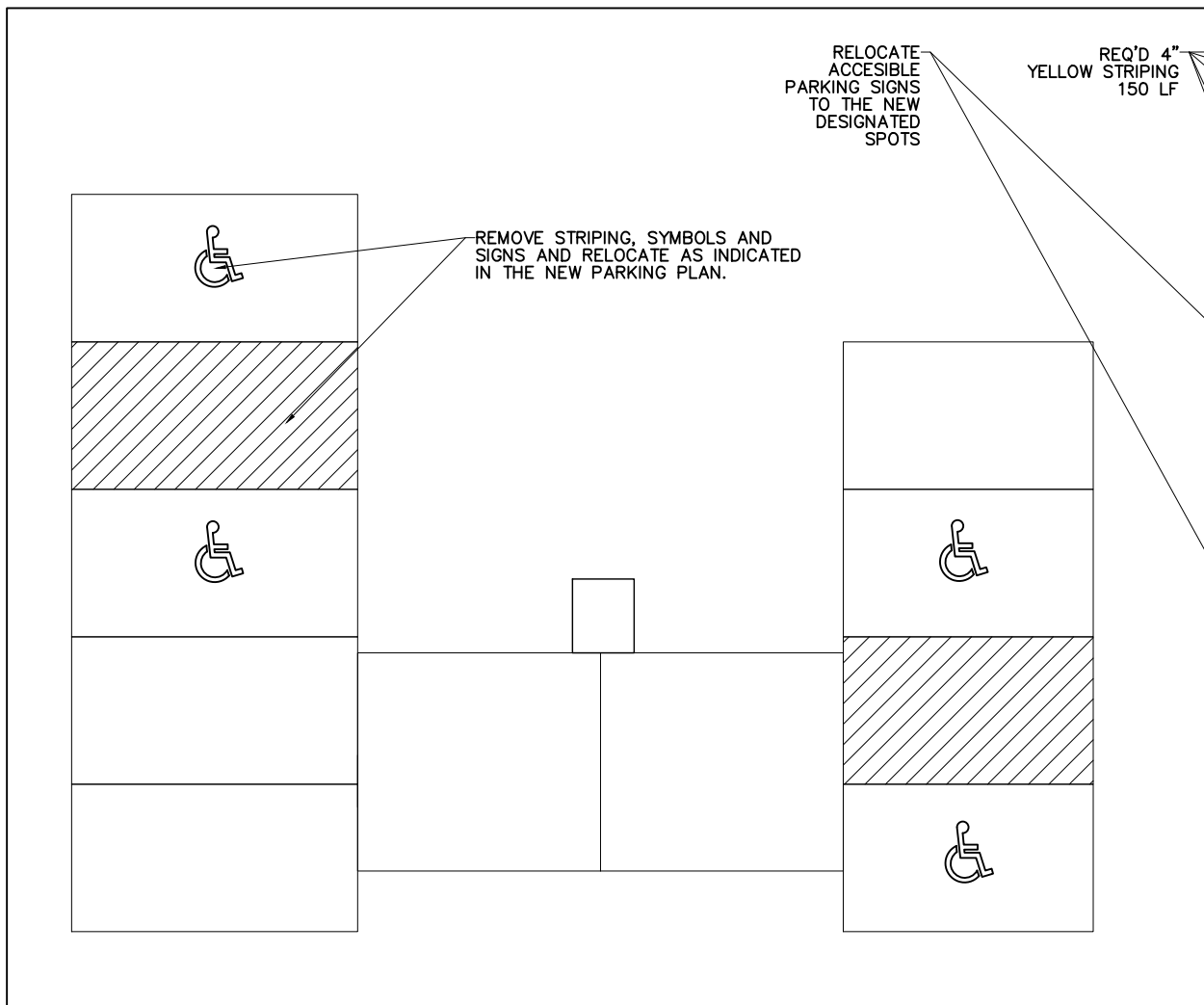

2 EXISTING PARKING  
SCALE: 3/16" = 1'-0" C-001 | C-007

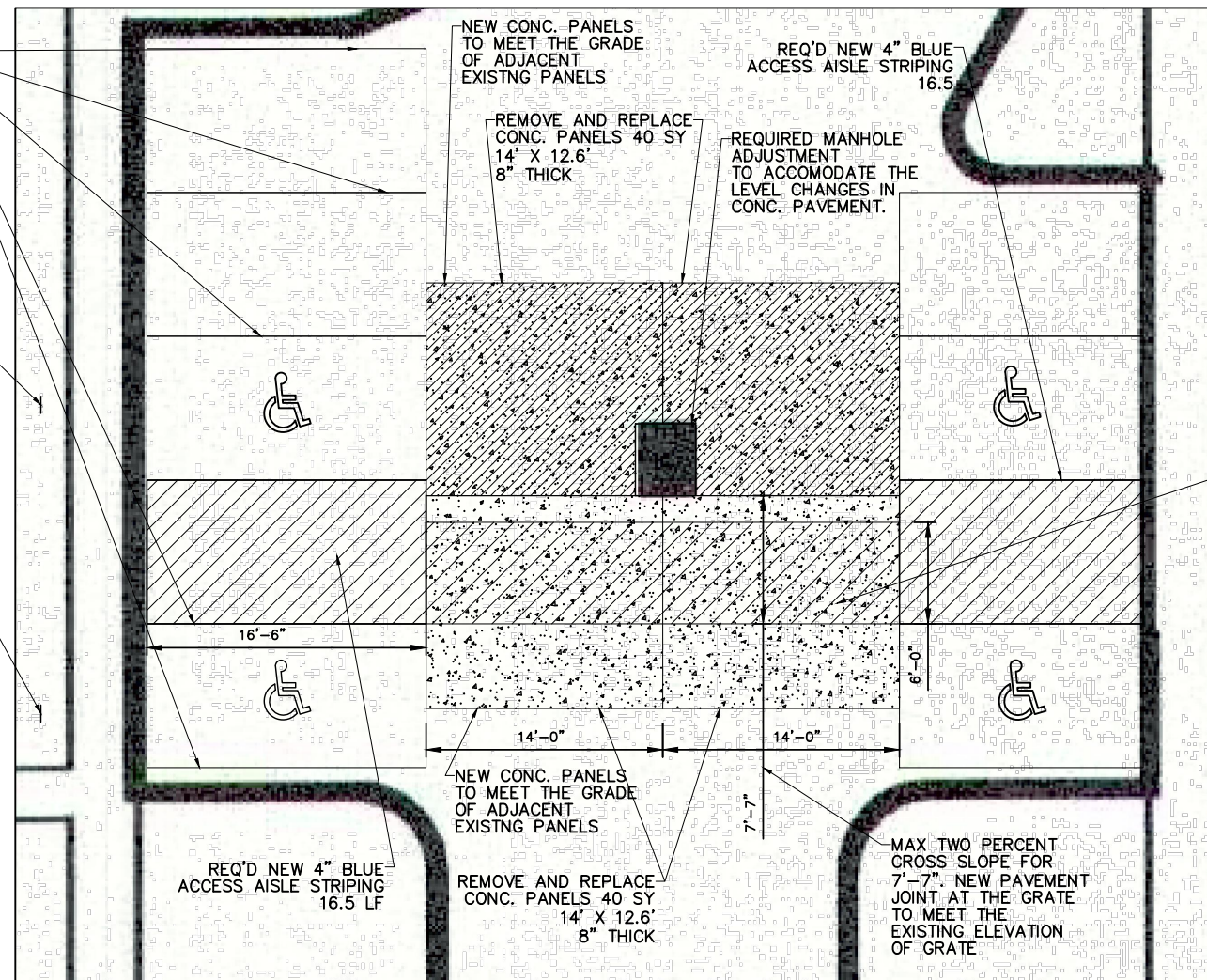

2 NEW PARKING STRIPING  
SCALE: 3/16" = 1'-0" C-001 | C-007

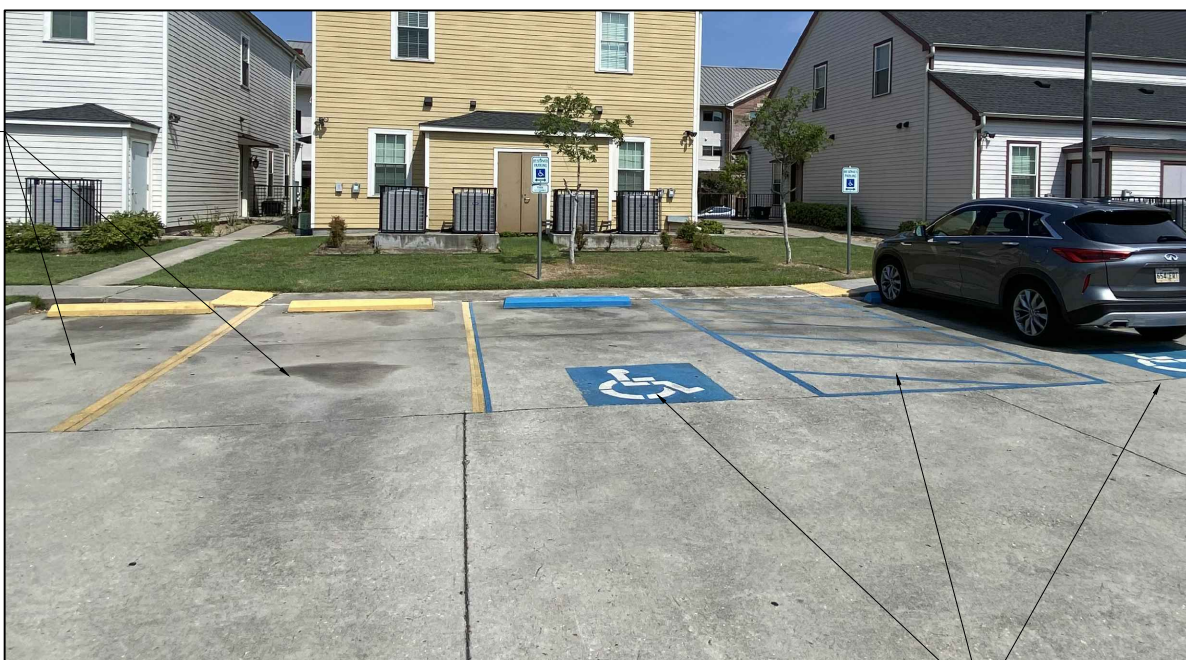
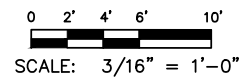

2  
SCALE: N.T.S. C-001 | C-007

RELOCATE ALL THREE ADA ACCESSIBLE PARKING SPOTS TO FAR LEFT ALONG WITH SIGN BOARDS AS INDICATED ON THE PLAN

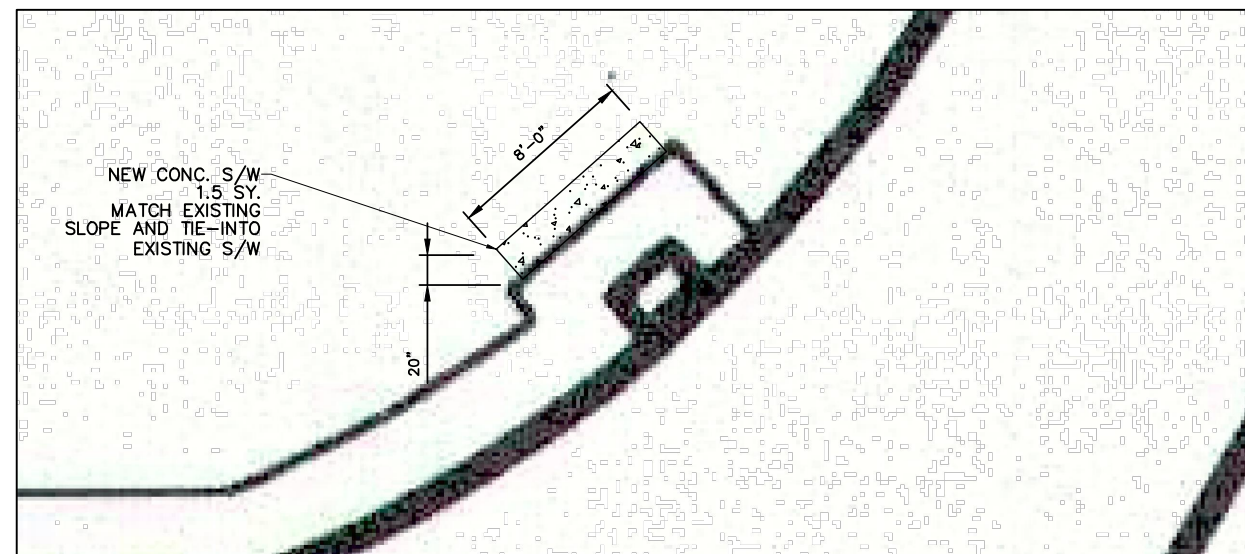

3  
SCALE: 1/4" = 1'-0" C-001 | C-007

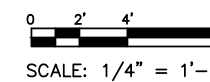

REVISIONS	BY

ARCHITECT/ENGINEER:  
**ECM Consultants, Inc.**  
ENGINEERS - ARCHITECTS - CONSTRUCTION MANAGERS  
1301 CLEARVIEW PKWY. SUITE 200  
METAIRIE, LOUISIANA 70001  
PHONE: (504) 885-4080. FAX: (504) 885-1439  
EMAIL: mail@ecmconsultants.com

OWNER:  
HOUSING AUTHORITY  
OF NEW ORLEANS  
2051 SENATE ST. BUILDING B. RM. 202  
NEW ORLEANS, LOUISIANA 70122

PROJECT:  
GUSTE III COMMUNITY  
INTERIOR & EXTERIOR REPAIRS  
SHEET TITLE:  
ACCESSIBLE ROUTES IMPROVEMENTS

DRAWN	K.A.
CHECKED	N.G.W.
DATE	JUN. 21, 2024
SCALE	AS SHOWN
JOB NO.	22462.14
SHEET NO.	C-007

C-007



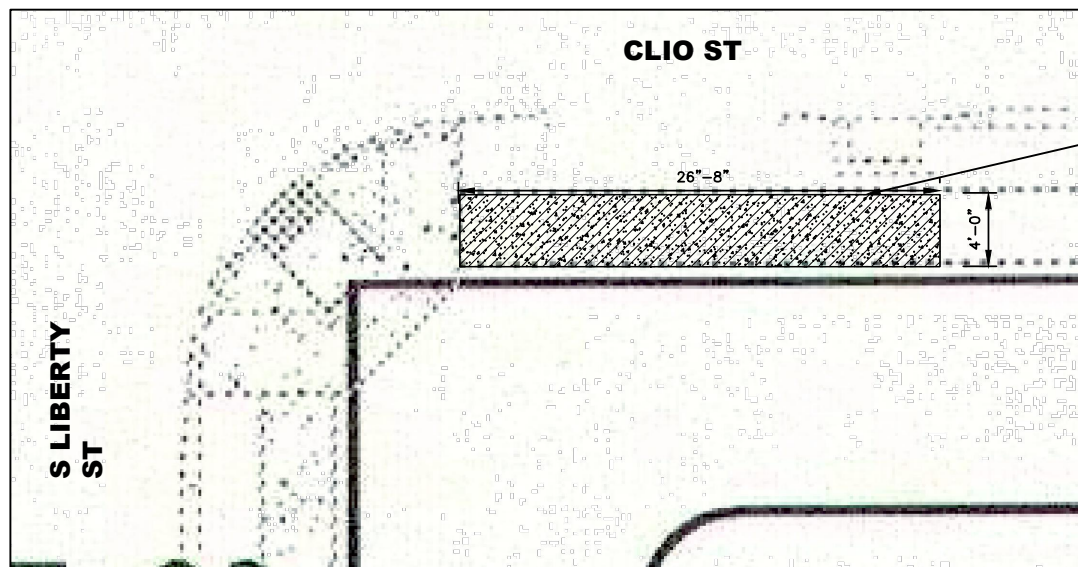

5 ABCDE  
SCALE: 3/16" = 1'-0" C-001 | C-008

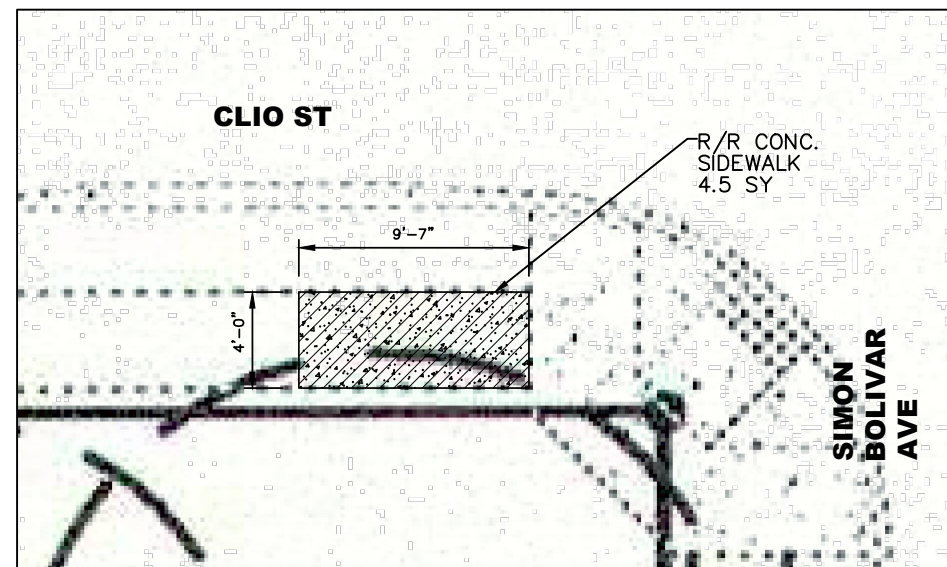

5 QR  
SCALE: 3/16" = 1'-0" C-001 | C-008

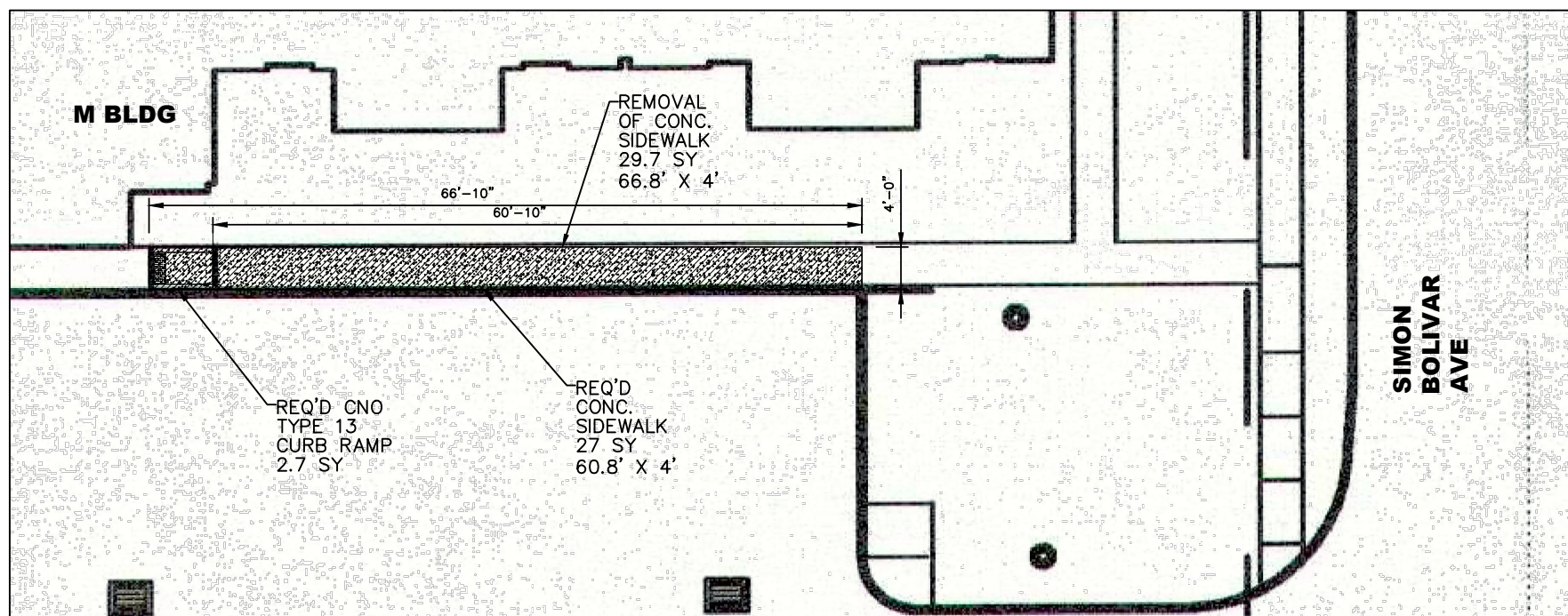

5 LMNOP  
SCALE: 1/8" = 1'-0" C-001 | C-008

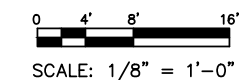

REVISIONS	BY

ARCHITECT/ENGINEER:  
**ECM Consultants, Inc.**  
ENGINEERS - ARCHITECTS - CONSTRUCTION MANAGERS  
1301 CLEARVIEW PKWY. SUITE 200  
METAIRIE, LOUISIANA 70001  
PHONE: (504) 885-4080, FAX: (504) 885-1439  
EMAIL: mail@ecmconsultants.com

OWNER:  
HOUSING AUTHORITY  
OF NEW ORLEANS  
2051 SENATE ST. BUILDING B, RM. 202  
NEW ORLEANS, LOUISIANA 70122

PROJECT:  
GUSTE III COMMUNITY  
INTERIOR & EXTERIOR REPAIRS  
SHEET TITLE:  
EXTERIOR IMPROVEMENTS

DRAWN K.A.
CHECKED N.G.W.
DATE JUN. 21, 2024
SCALE AS SHOWN
JOB NO. 22462.14
SHEET NO.

C-008



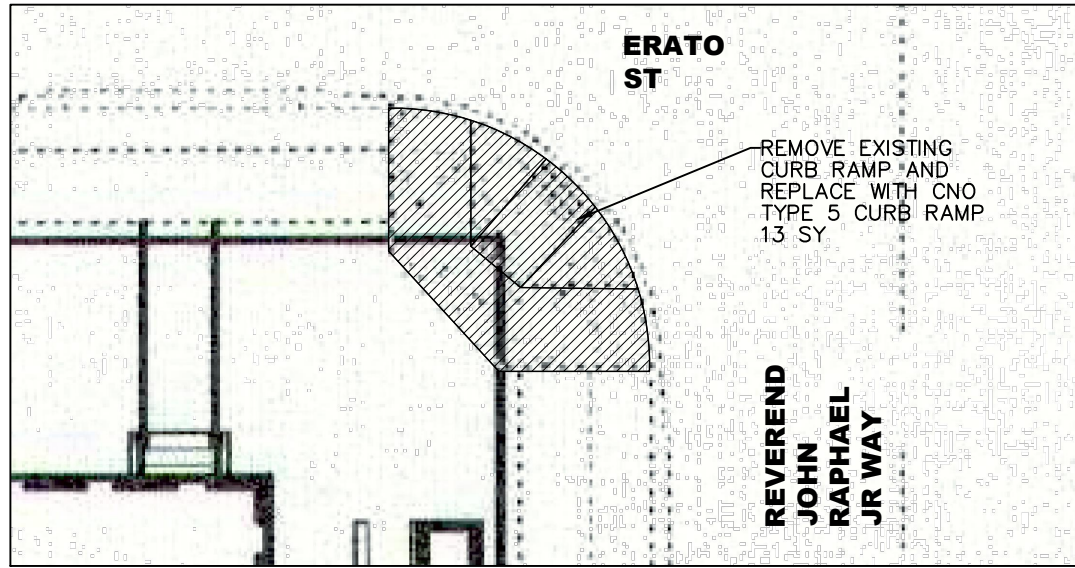

5 S  
SCALE: 3/16" = 1'-0" C-001 | C-009

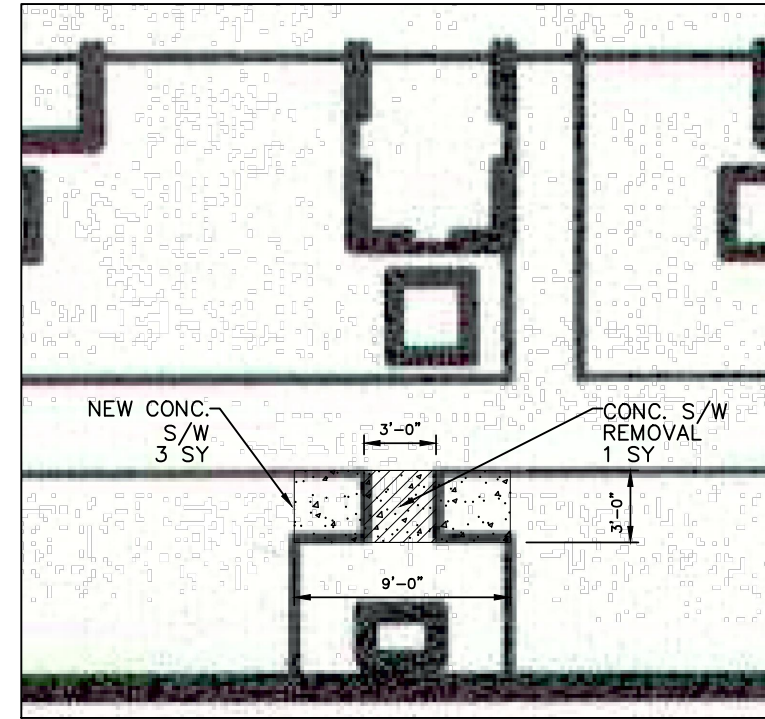

5 Z  
SCALE: 1/4" = 1'-0" C-001 | C-009

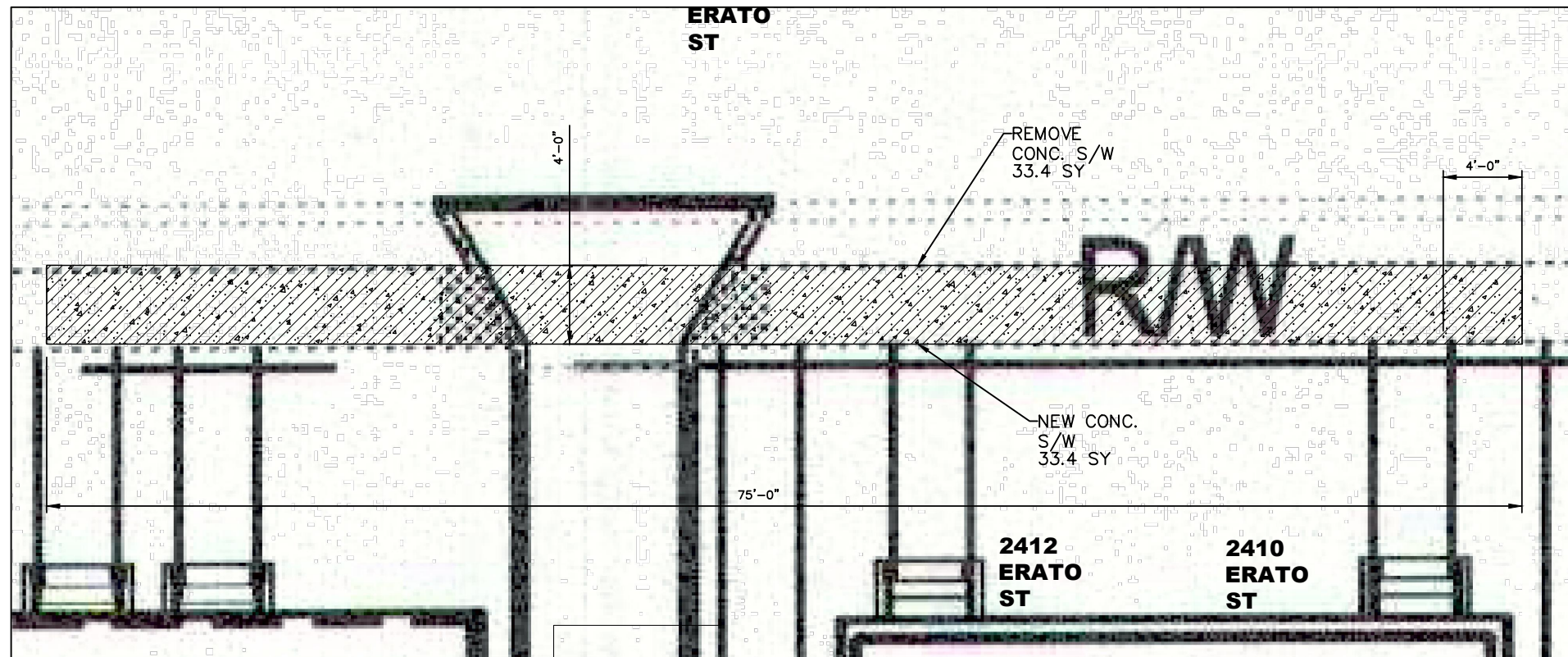

5 T  
SCALE: 1/4" = 1'-0" C-001 | C-009

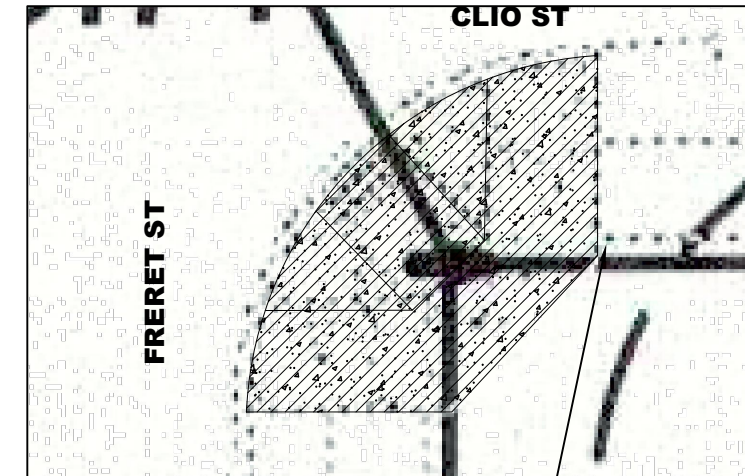

5 DD  
SCALE: 1/4" = 1'-0" C-001 | C-010

REMOVE EXISTING CURB RAMP AND REPLACE WITH CNO TYPE 5 CURB RAMP 16.5 SY

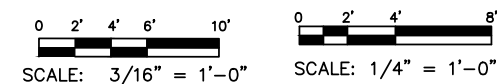

REVISIONS	BY

**ECM Consultants, Inc.**  
 ARCHITECT/ENGINEER  
 ENGINEERS - ARCHITECTS - CONSTRUCTION MANAGERS  
 1301 CLEARVIEW PKWY. SUITE 200  
 METAIRIE, LOUISIANA 70001  
 PHONE: (504) 885-4080, FAX: (504) 885-1439  
 EMAIL: mail@ecmconsultants.com

OWNER:  
 HOUSING AUTHORITY  
 OF NEW ORLEANS  
 2051 SENATE ST. BUILDING B, RM. 202  
 NEW ORLEANS, LOUISIANA 70122

PROJECT:  
 GUSTE III COMMUNITY  
 INTERIOR & EXTERIOR REPAIRS  
 SHEET TITLE:  
 EXTERIOR IMPROVEMENTS

DRAWN  
 K.A.  
 CHECKED  
 N.G.W.  
 DATE  
 JUN. 21, 2024  
 SCALE  
 AS SHOWN  
 JOB NO.  
 22462.14  
 SHEET NO.

C-009



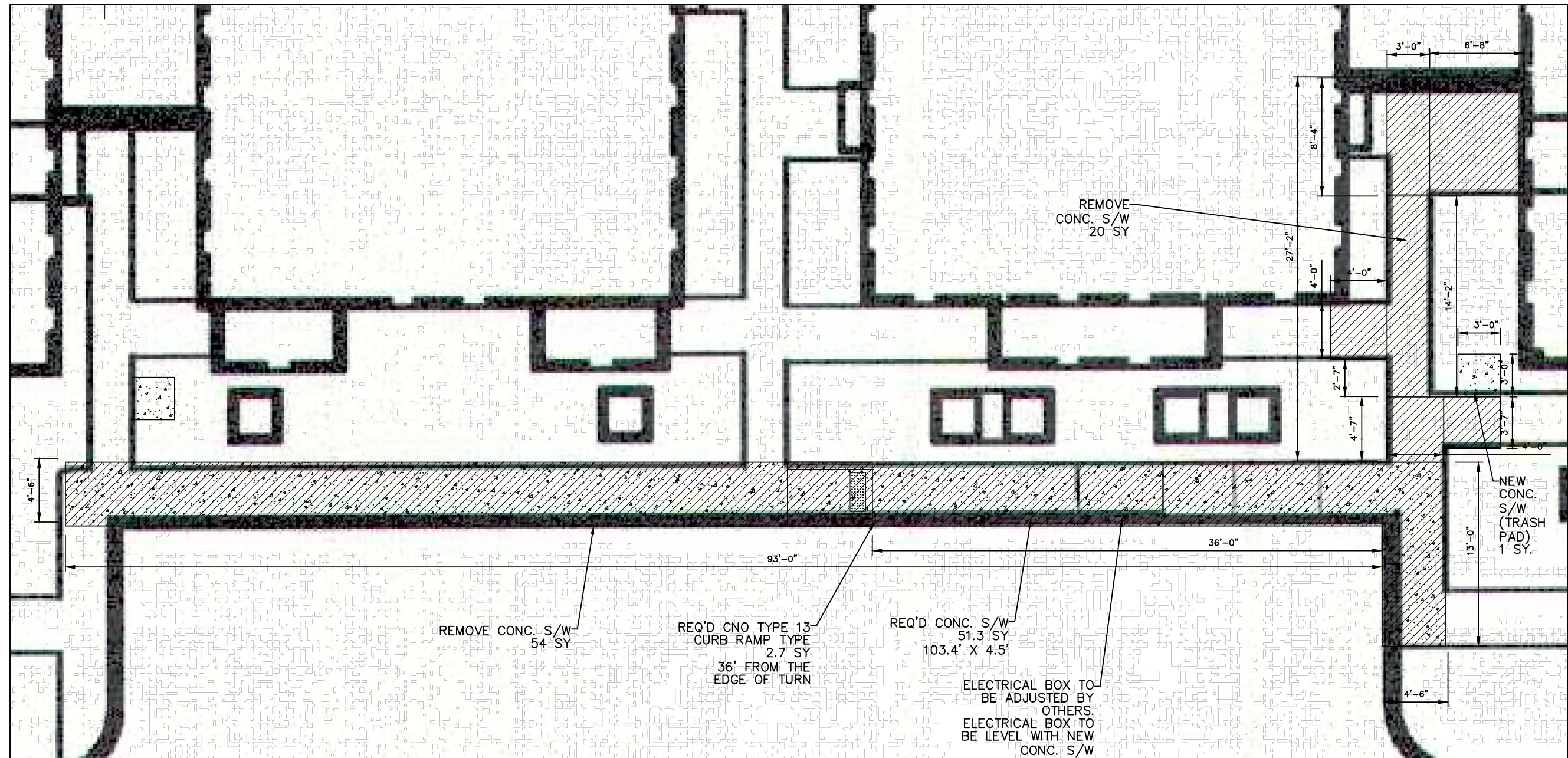

5 Y & AA & 2310 ERATO ST

SCALE: 1/4" = 1'-0"

C-001 | C-010



2310 ERATO ST

SCALE: N.T.S

C-001 | C-010



0 2' 4' 8'  
SCALE: 1/4" = 1'-0"

REVISIONS	BY

ARCHITECT/ENGINEER:  
**ECM Consultants, Inc.**  
ENGINEERS - ARCHITECTS - CONSTRUCTION MANAGERS  
1301 CLEARVIEW PKWY. SUITE 200  
METAIRIE, LOUISIANA 70001  
PHONE: (504) 885-4080. FAX: (504) 885-1439  
EMAIL: mail@ecmconsultants.com

OWNER:  
HOUSING AUTHORITY  
OF NEW ORLEANS  
2051 SENATE ST. BUILDING B. RM. 202  
NEW ORLEANS, LOUISIANA 70122

PROJECT:  
GUSTE III COMMUNITY  
INTERIOR & EXTERIOR REPAIRS  
SHEET TITLE:  
EXTERIOR IMPROVEMENTS

DRAWN K.A.
CHECKED N.G.W.
DATE JUN. 21, 2024
SCALE AS SHOWN
JOB NO. 22462.14
SHEET NO.

C-010



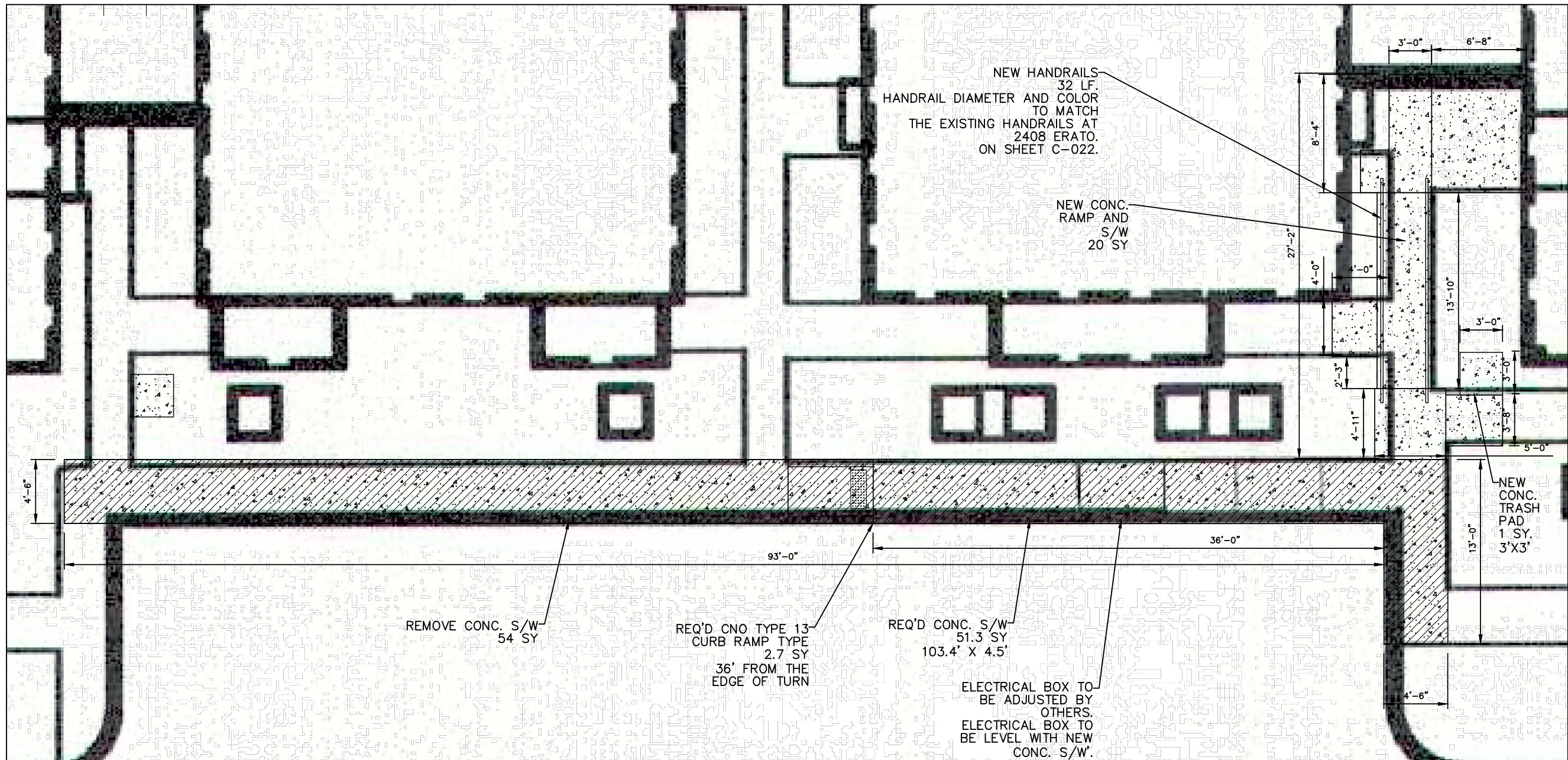

5 Y & AA & 2310 ERATO ST

SCALE: 1/4" = 1'-0"

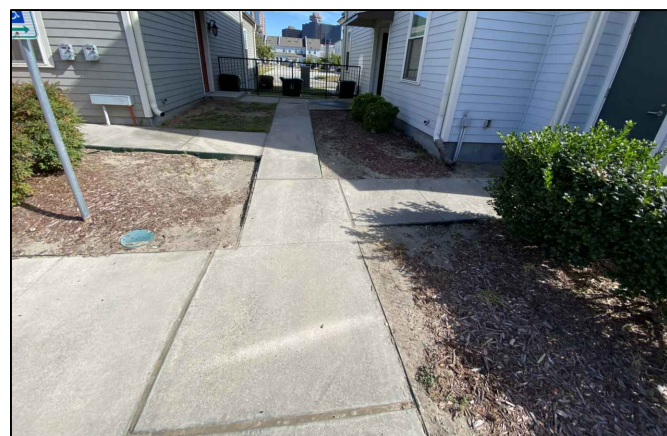
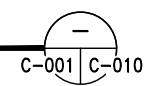

2310 ERATO ST

SCALE: N.T.S

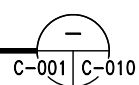

REVISIONS	BY

ARCHITECT/ENGINEER:  
**ECM Consultants, Inc.**  
ENGINEERS - ARCHITECTS - CONSTRUCTION MANAGERS  
1301 CLEARVIEW PKWY. SUITE 200  
METAIRIE, LOUISIANA 70001  
PHONE: (504) 885-4080, FAX: (504) 885-1439  
EMAIL: mail@ecmconsultants.com

OWNER:  
HOUSING AUTHORITY  
OF NEW ORLEANS  
2051 SENATE ST. BUILDING B, RM. 202  
NEW ORLEANS, LOUISIANA 70122

PROJECT:  
GUSTE III COMMUNITY  
INTERIOR & EXTERIOR REPAIRS  
SHEET TITLE:  
EXTERIOR IMPROVEMENTS

DRAWN K.A.
CHECKED N.G.W.
DATE JUN. 21, 2024
SCALE AS SHOWN
JOB NO. 22462.14
SHEET NO.

C-010A





5 00  
SCALE: N.T.S

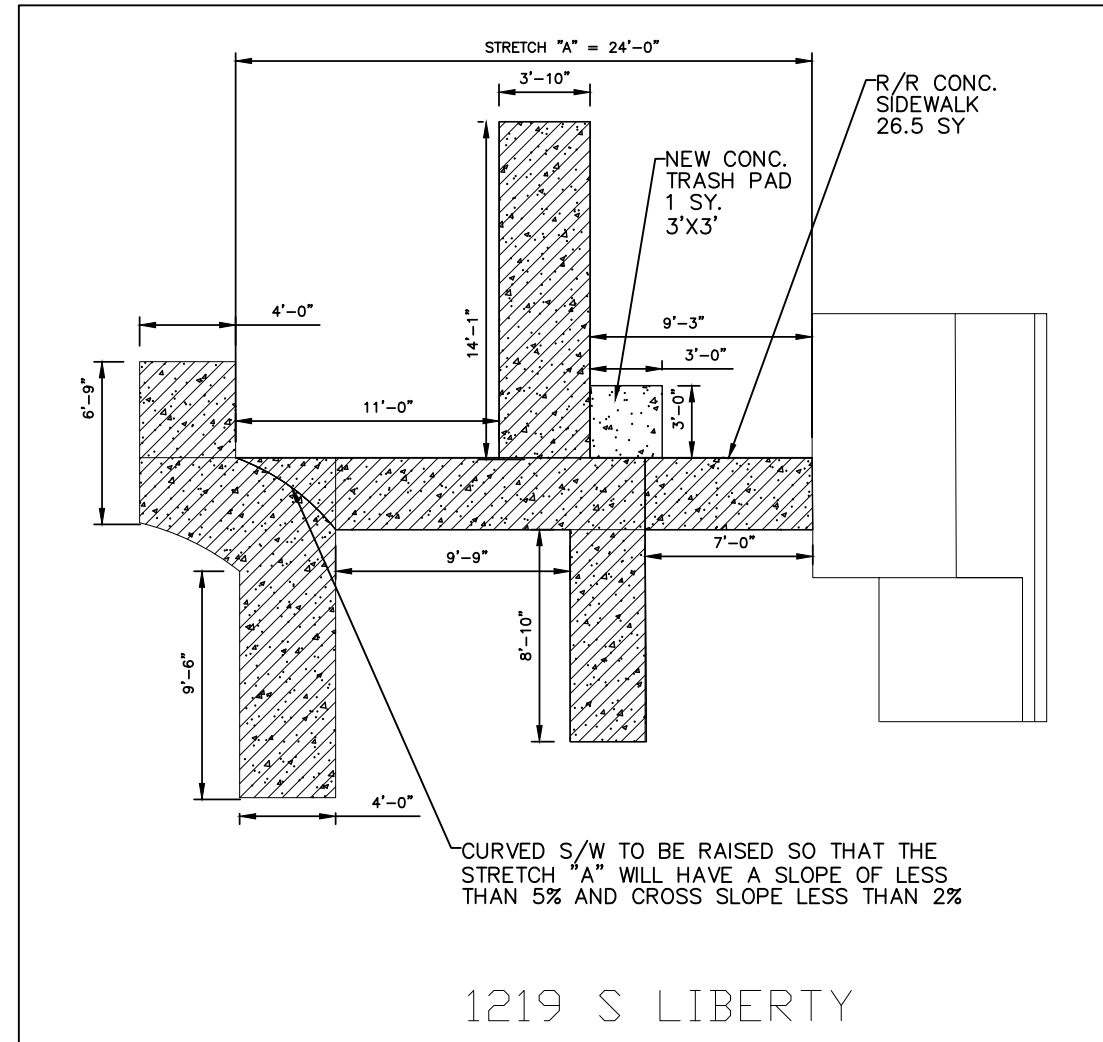
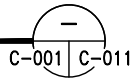

5 00  
SCALE: 1/4" = 1'-0"

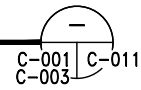

REVISIONS	BY

ARCHITECT/ENGINEER:  
**ECM Consultants, Inc.**  
ENGINEERS - ARCHITECTS - CONSTRUCTION MANAGERS  
1301 CLEARVIEW PKWY. SUITE 200  
METAIRIE, LOUISIANA 70001  
PHONE: (504) 885-4080, FAX: (504) 885-1439  
EMAIL: mail@ecmconsultants.com

OWNER:  
HOUSING AUTHORITY  
OF NEW ORLEANS  
2051 SENATE ST. BUILDING B, RM. 202  
NEW ORLEANS, LOUISIANA 70122

PROJECT:  
GUSTE III COMMUNITY  
INTERIOR & EXTERIOR REPAIRS  
SHEET TITLE:  
EXTERIOR IMPROVEMENTS

DRAWN K.A.
CHECKED N.G.W.
DATE JUN. 21, 2024
SCALE AS SHOWN
JOB NO. 22462.14
SHEET NO.

C-011



NOT USED

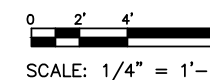

SCALE: 1/4" = 1'-0"

REVISIONS	BY

ARCHITECT/ENGINEER:  
**ECM Consultants, Inc.**  
 ENGINEERS - ARCHITECTS - CONSTRUCTION MANAGERS  
 1301 CLEARVIEW PKWY. SUITE 200  
 METAIRIE, LOUISIANA 70001  
 PHONE: (504) 885-4080, FAX: (504) 885-1439  
 EMAIL: mail@ecmconsultants.com

OWNER:  
 HOUSING AUTHORITY  
 OF NEW ORLEANS  
 2051 SENATE ST. BUILDING B, RM. 202  
 NEW ORLEANS, LOUISIANA 70122

PROJECT:  
 GUSTE III COMMUNITY  
 INTERIOR & EXTERIOR REPAIRS  
 SHEET TITLE:  
 EXTERIOR IMPROVEMENTS

DRAWN
K.A.
CHECKED
N.G.W.
DATE
JUN. 21, 2024
SCALE
AS SHOWN
JOB NO.
22462.14
SHEET NO.
C-012

NOT USED

REVISIONS	BY

ARCHITECT/ENGINEER:  
**ECM Consultants, Inc.**  
ENGINEERS – ARCHITECTS – CONSTRUCTION MANAGERS  
1301 CLEARVIEW PKWY. SUITE 200  
METAIRIE, LOUISIANA 70001  
PHONE: (504) 885-4080, FAX: (504) 885-1439  
EMAIL: mail@ecmconsultants.com

OWNER:  
HOUSING AUTHORITY  
OF NEW ORLEANS  
2051 SENATE ST. BUILDING B, RM. 202  
NEW ORLEANS, LOUISIANA 70122

PROJECT:  
GUSTE III COMMUNITY  
INTERIOR & EXTERIOR REPAIRS  
SHEET TITLE:  
EXTERIOR IMPROVEMENTS

DRAWN  
K.A.  
CHECKED  
N.G.W.  
DATE  
JUN. 21, 2024  
SCALE  
AS SHOWN  
JOB NO.  
22462.14  
SHEET NO.

C-013



6 EFGHI

SCALE: N.T.S

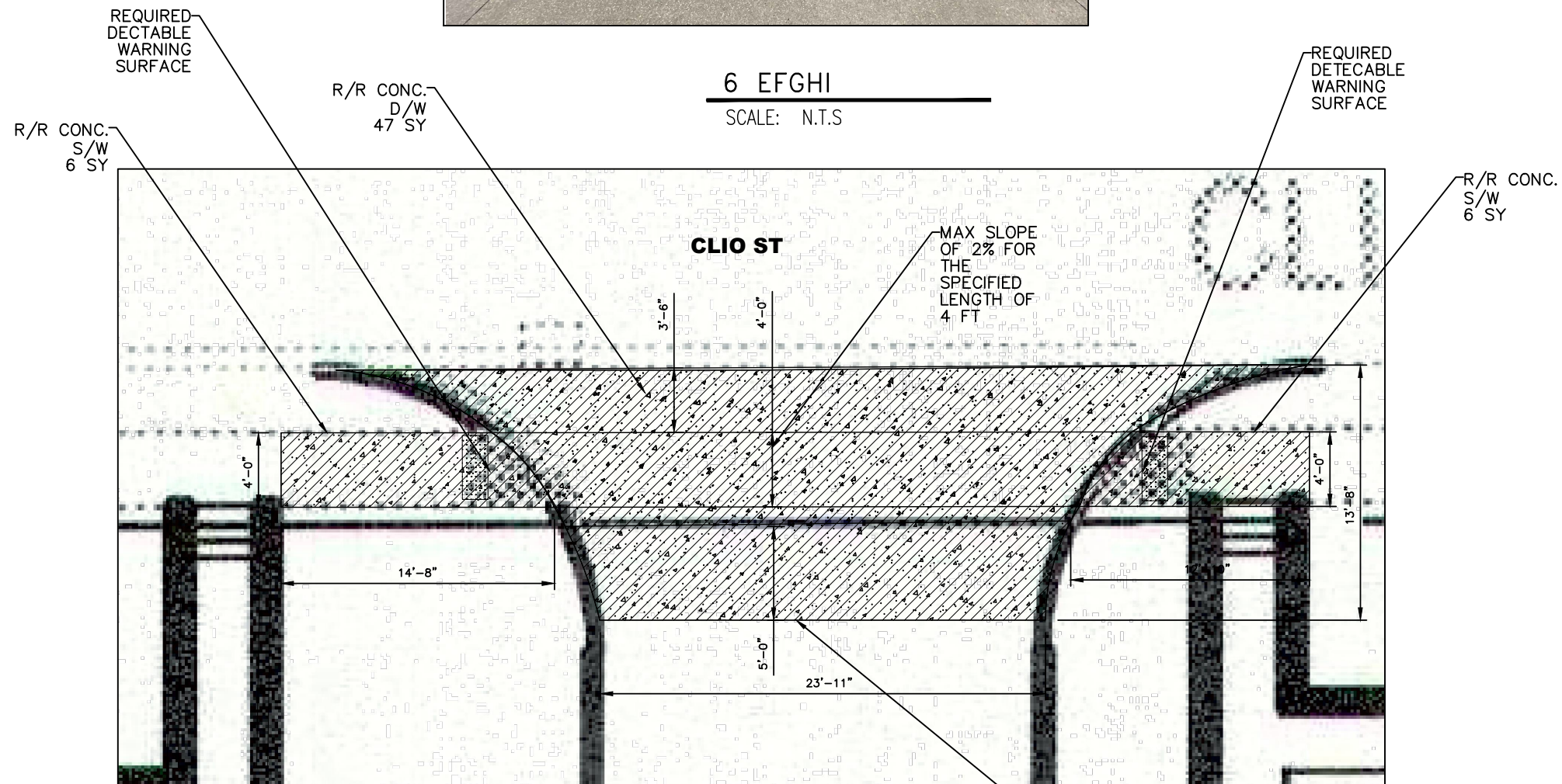

5 CC & 6 EFGHI

SCALE: 1/4" = 1'-0"

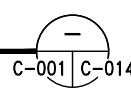

EDGE OF NEW DRIVEWAY PAVEMENT TO MEET THE EXISTING ADJACENT PAVEMENT ELEVATION



SCALE: 1/4" = 1'-0"

REVISIONS	BY

ARCHITECT/ENGINEER:  
**ECM Consultants, Inc.**  
 ENGINEERS - ARCHITECTS - CONSTRUCTION MANAGERS  
 1301 CLEARVIEW PKWY. SUITE 200  
 METAIRIE, LOUISIANA 70001  
 PHONE: (504) 885-4080, FAX: (504) 885-1439  
 EMAIL: mail@ecmconsultants.com

OWNER:  
 HOUSING AUTHORITY  
 OF NEW ORLEANS  
 2051 SENATE ST. BUILDING B, RM. 202  
 NEW ORLEANS, LOUISIANA 70122

PROJECT:  
 GUSTE III COMMUNITY  
 INTERIOR & EXTERIOR REPAIRS  
 SHEET TITLE:  
 EXTERIOR IMPROVEMENTS

DRAWN	K.A.
CHECKED	N.G.W.
DATE	JUN. 21, 2024
SCALE	AS SHOWN
JOB NO.	22462.14
SHEET NO.	C-014

C-014





7  
SCALE: N.T.S

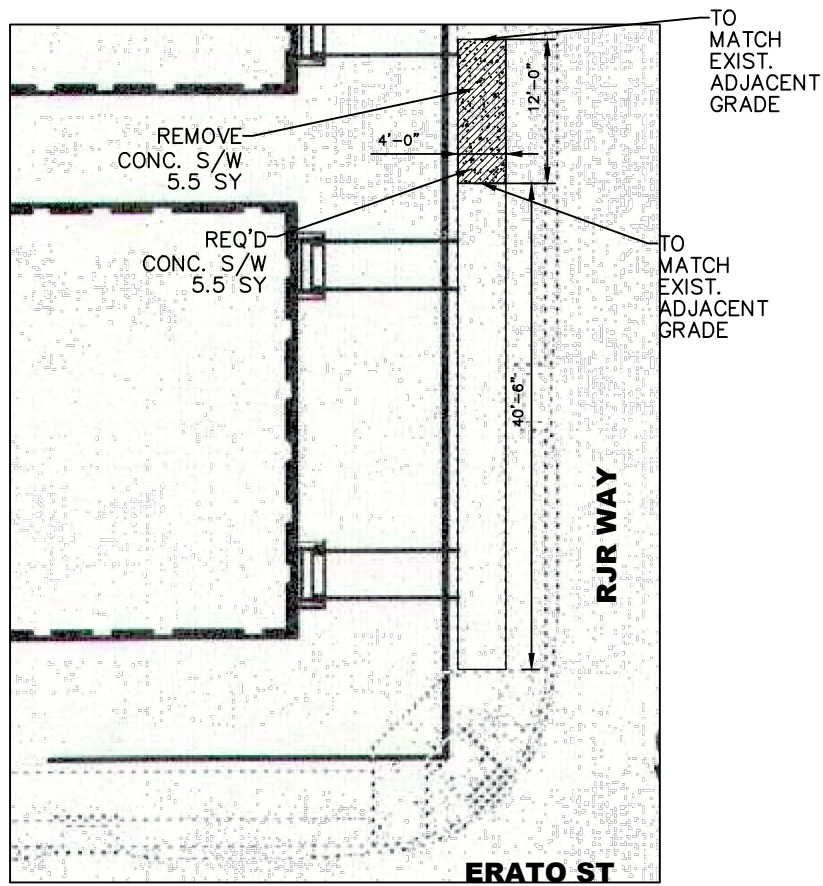

7  
SCALE: 1/8" = 1'-0" C-001 C-015

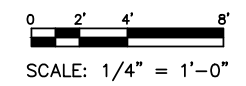

REVISIONS	BY

ARCHITECT/ENGINEER:  
**ECM Consultants, Inc.**  
 ENGINEERS - ARCHITECTS - CONSTRUCTION MANAGERS  
 1301 CLEARVIEW PKWY. SUITE 200  
 METAIRIE, LOUISIANA 70001  
 PHONE: (504) 885-4080, FAX: (504) 885-1439  
 EMAIL: mail@ecmconsultants.com

OWNER:  
 HOUSING AUTHORITY  
 OF NEW ORLEANS  
 2051 SENATE ST. BUILDING B, RM. 202  
 NEW ORLEANS, LOUISIANA 70122

PROJECT:  
 GUSTE III COMMUNITY  
 INTERIOR & EXTERIOR REPAIRS  
 SHEET TITLE:  
 EXTERIOR IMPROVEMENTS

DRAWN K.A.
CHECKED N.G.W.
DATE JUN. 21, 2024
SCALE AS SHOWN
JOB NO. 22462.14
SHEET NO.

C-015





REVISIONS	BY

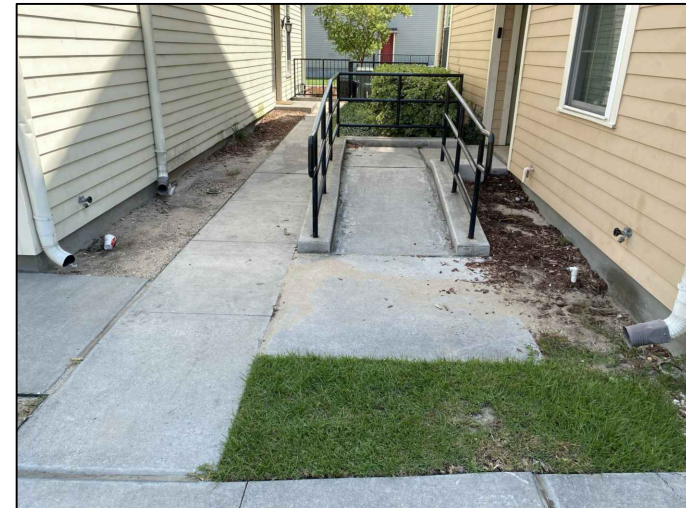
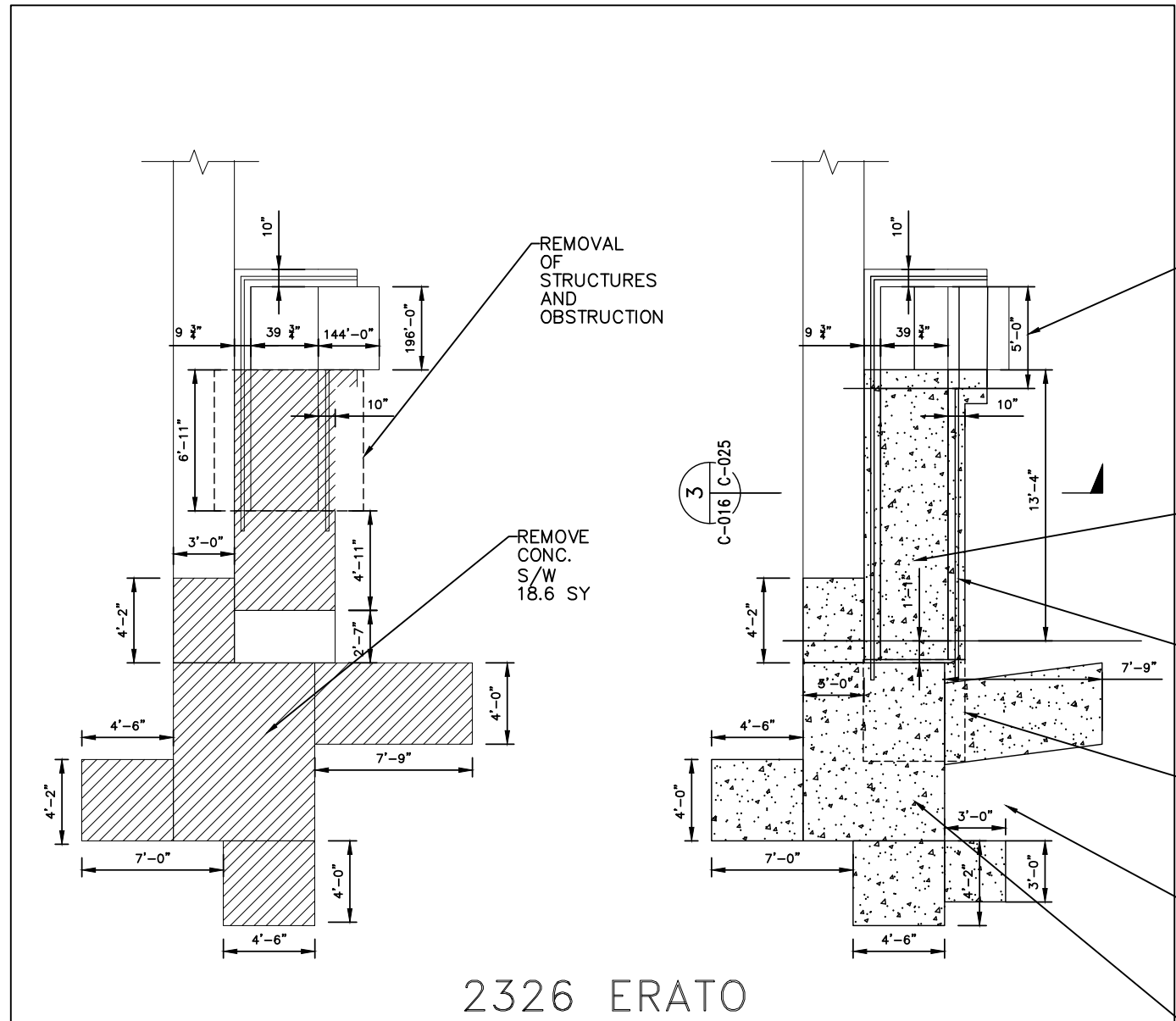

9B & 8C  
SCALE: N.T.S

REMOVAL OF STRUCTURES AND OBSTRUCTION

REMOVE CONC. S/W 18.6 SY

CROSS SLOPE LESS THAN 2% IN BOTH DIRECTION FOR THIS 5FT LENGTH AS THIS IS LANDING OF RAMP.

NEW CONCRETE RAMP 7.5 SY.

REQ'D NEW HANDRAILS. 29 LF HANDRAILS TO MATCH EXISTING SIZE AND SHAPE.

BROKEN LINE SHOWS THE 5' X 5' REQUIRED LANDING IS ACHIEVED AFTER NEW CONC IS PLACED AS PER PLANS

NEW CONC. TRASH PAD 1 SY.

NEW CONCRETE SW 16.5 SY.

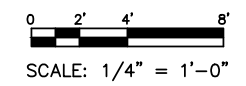

ARCHITECT/ENGINEER:

**ECM Consultants, Inc.**  
 ENGINEERS - ARCHITECTS - CONSTRUCTION MANAGERS  
 1301 CLEARVIEW PKWY. SUITE 200  
 METAIRIE, LOUISIANA 70001  
 PHONE: (504) 885-4080, FAX: (504) 885-1439  
 EMAIL: mail@ecmconsultants.com

OWNER:

HOUSING AUTHORITY OF NEW ORLEANS  
 2051 SENATE ST. BUILDING B, RM. 202  
 NEW ORLEANS, LOUISIANA 70122

PROJECT:

GUSTE III COMMUNITY INTERIOR & EXTERIOR REPAIRS

SHEET TITLE:

EXTERIOR IMPROVEMENTS

DRAWN	K.A.
CHECKED	N.G.W.
DATE	JUN. 21, 2024
SCALE	AS SHOWN
JOB NO.	22462.14
SHEET NO.	

C-016





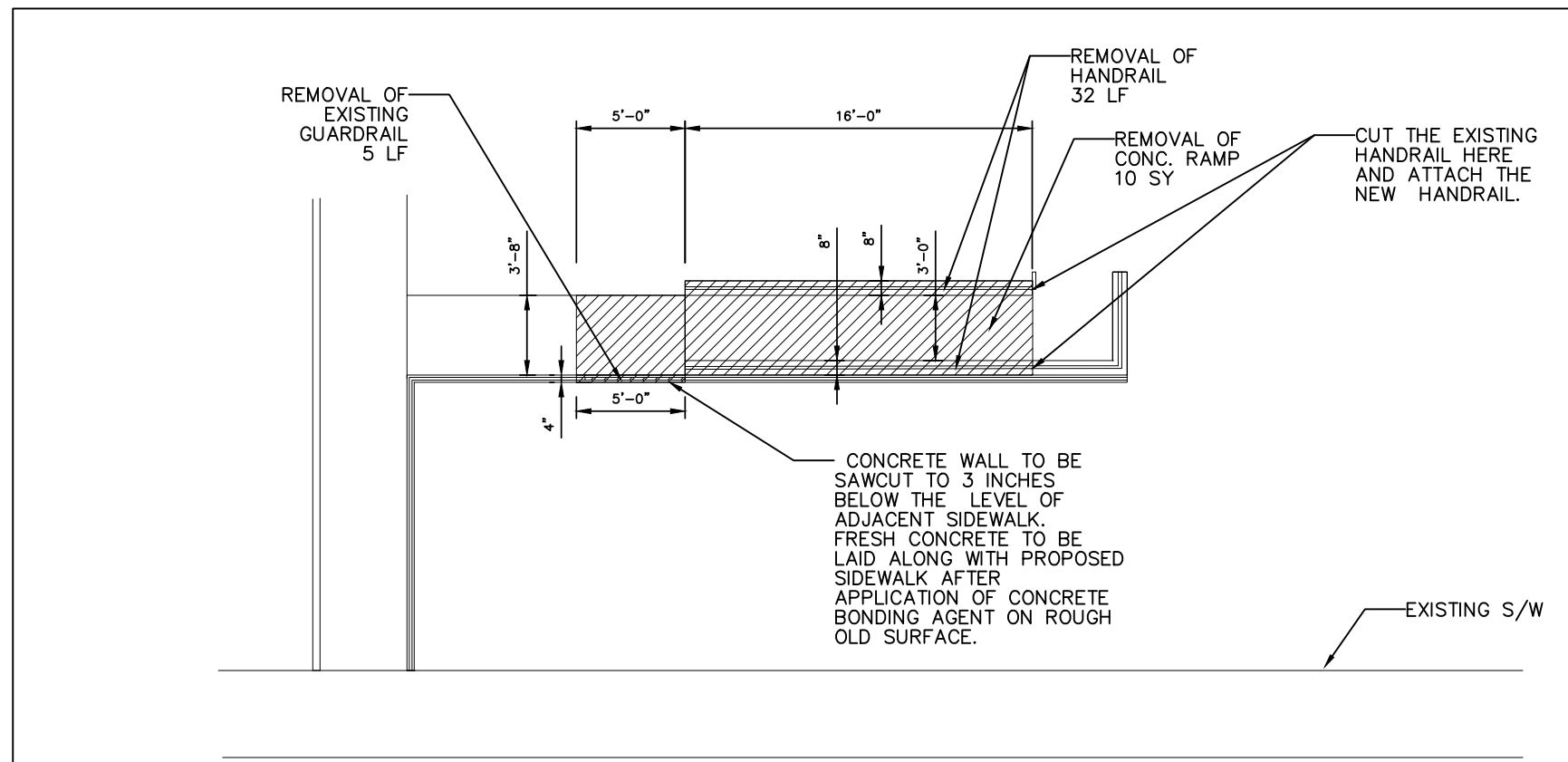

9E  
 SCALE: 1/4" = 1'-0" C-001 | C-018

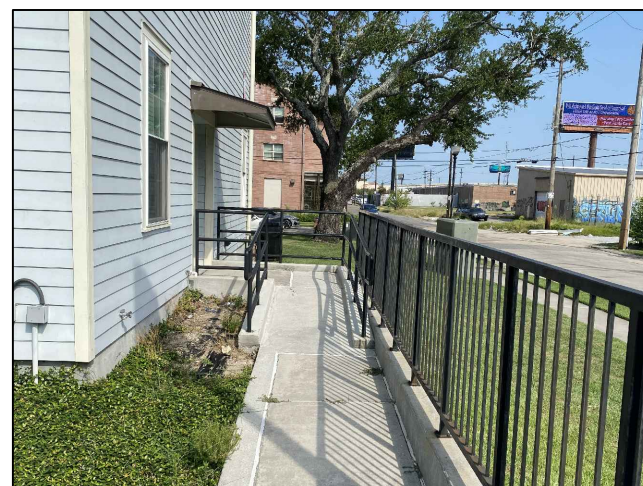

9E  
 SCALE: N.T.S

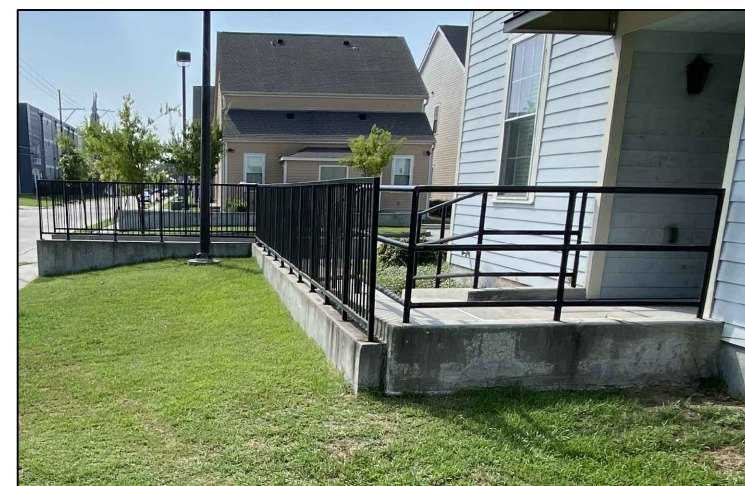

9E  
 SCALE: N.T.S

0 2' 4' 8'  
 SCALE: 1/4" = 1'-0"

REVISIONS	BY

ARCHITECT/ENGINEER:  
**ECM Consultants, Inc.**  
 ENGINEERS - ARCHITECTS - CONSTRUCTION MANAGERS  
 1301 CLEARVIEW PKWY. SUITE 200  
 METAIRIE, LOUISIANA 70001  
 PHONE: (504) 885-4080, FAX: (504) 885-1439  
 EMAIL: mail@ecmconsultants.com

OWNER:  
 HOUSING AUTHORITY  
 OF NEW ORLEANS  
 2051 SENATE ST. BUILDING B, RM. 202  
 NEW ORLEANS, LOUISIANA 70122

PROJECT:  
 GUSTE III COMMUNITY  
 INTERIOR & EXTERIOR REPAIRS  
 SHEET TITLE:  
 ACCESSIBLE ROUTES IMPROVEMENTS

DRAWN  
 K.A.  
 CHECKED  
 N.G.W.  
 DATE  
 JUN. 21, 2024  
 SCALE  
 AS SHOWN  
 JOB NO.  
 22462.14  
 SHEET NO.

C-018

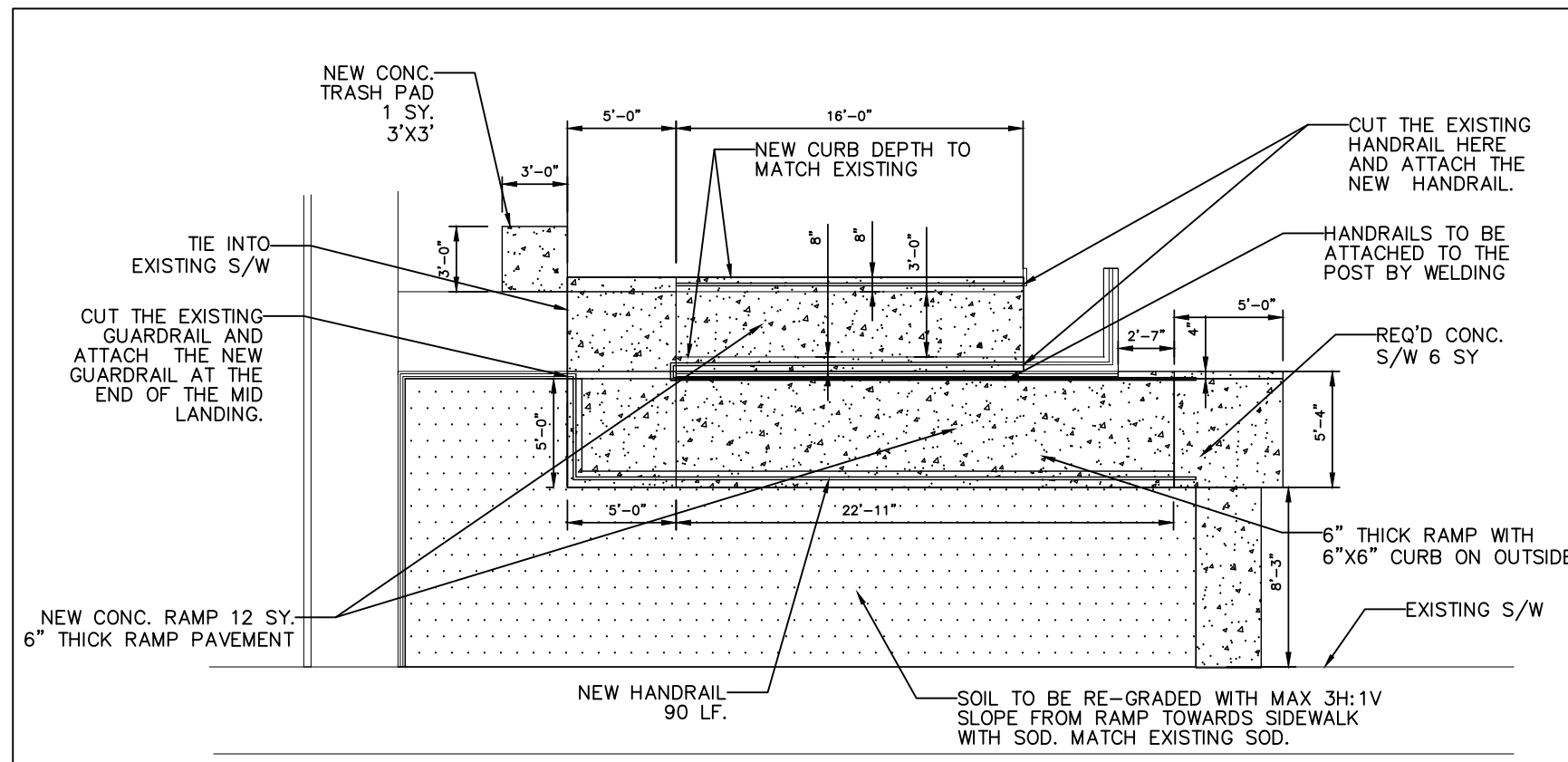

9E  
SCALE: 1/4" = 1'-0" C-001 | C-018A

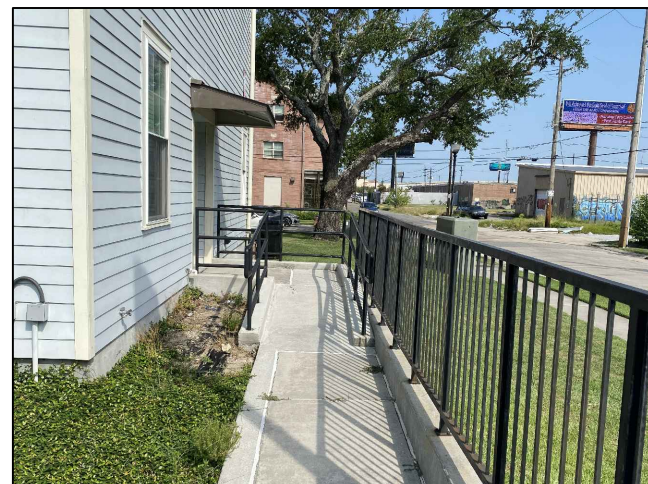

9E  
SCALE: N.T.S

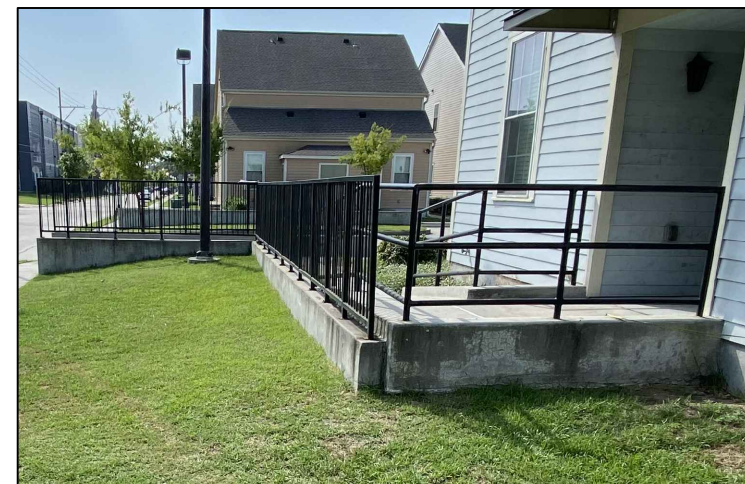

9E  
SCALE: N.T.S

0 2' 4' 8'  
SCALE: 1/4" = 1'-0"

REVISIONS	BY

ARCHITECT/ENGINEER:  
**ECM Consultants, Inc.**  
ENGINEERS - ARCHITECTS - CONSTRUCTION MANAGERS  
1301 CLEARVIEW PKWY. SUITE 200  
METAIRIE, LOUISIANA 70001  
PHONE: (504) 885-4080, FAX: (504) 885-1439  
EMAIL: mail@ecmconsultants.com

OWNER:  
HOUSING AUTHORITY  
OF NEW ORLEANS  
2051 SENATE ST. BUILDING B, RM. 202  
NEW ORLEANS, LOUISIANA 70122

PROJECT:  
GUSTE III COMMUNITY  
INTERIOR & EXTERIOR REPAIRS  
SHEET TITLE:  
ACCESSIBLE ROUTES IMPROVEMENTS

DRAWN  
K.A.  
CHECKED  
N.G.W.  
DATE  
JUN. 21, 2024  
SCALE  
AS SHOWN  
JOB NO.  
22462.14  
SHEET NO.

C-018A



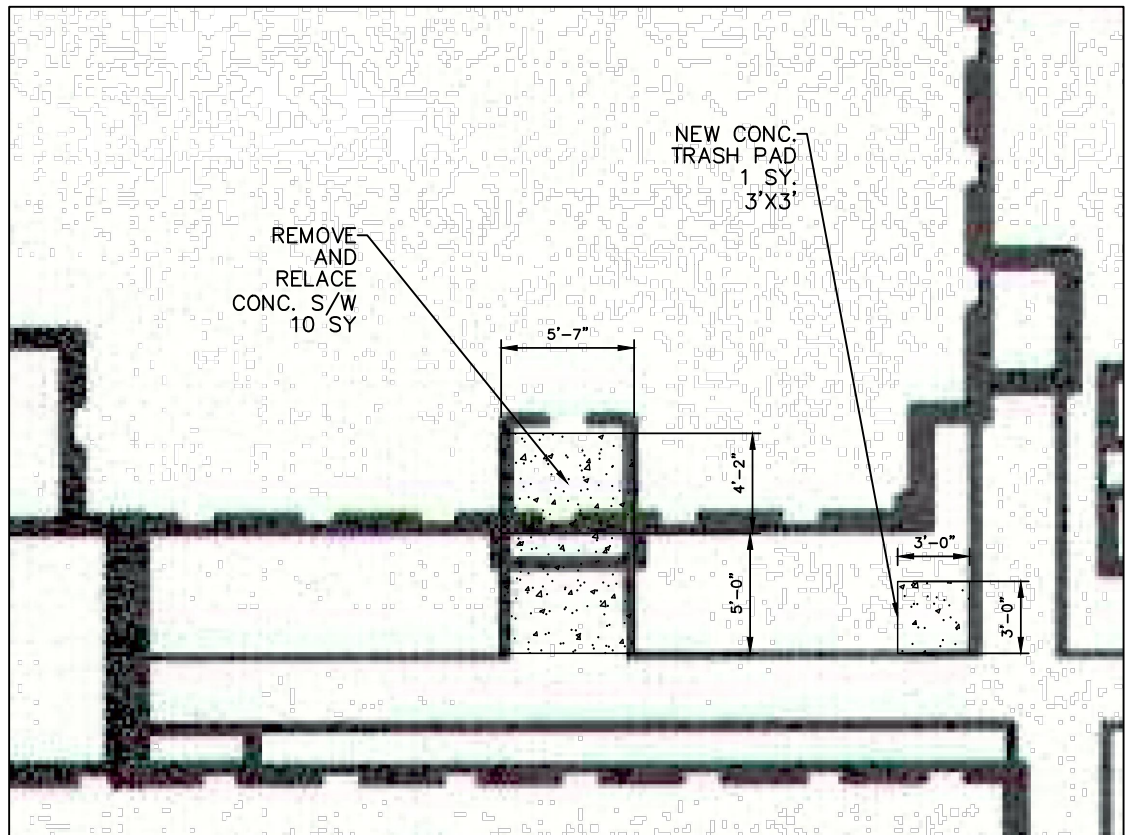

9 F  
SCALE: 1/4" = 1'-0" C-001 C-019

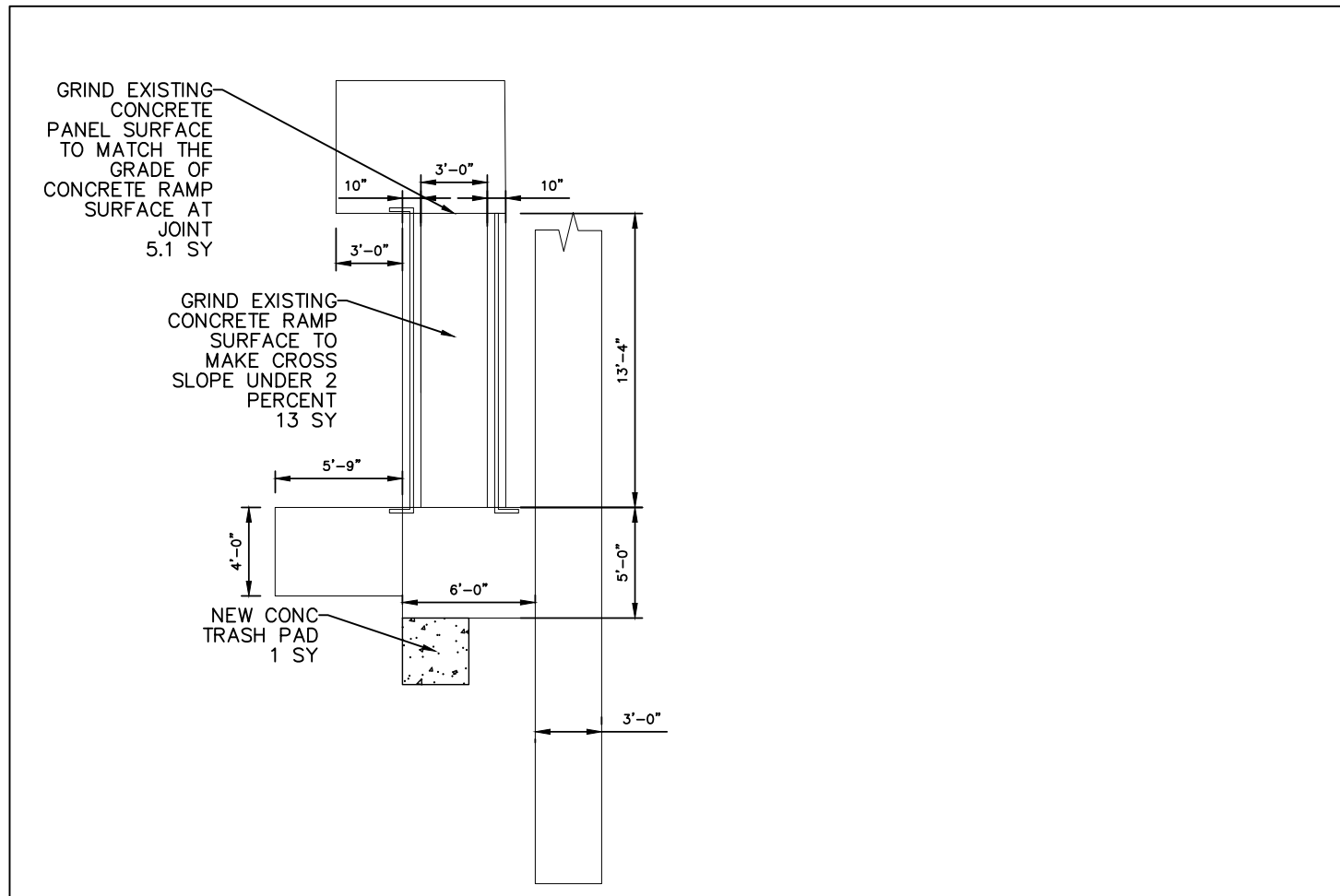

10 B  
SCALE: 1/4" = 1'-0" C-001 C-019

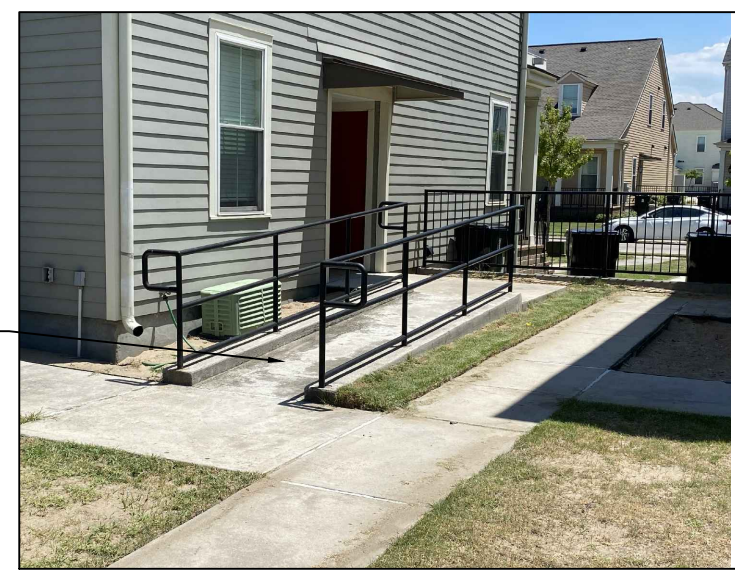

GRIND EXISTING CONCRETE RAMP SURFACE TO REDUCE CROSS SLOPE.

10 B  
SCALE: N.T.S

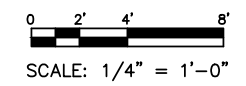

REVISIONS	BY

ARCHITECT/ENGINEER:  
**ECM Consultants, Inc.**  
ENGINEERS - ARCHITECTS - CONSTRUCTION MANAGERS  
1301 CLEARVIEW PKWY. SUITE 200  
METAIRIE, LOUISIANA 70001  
PHONE: (504) 885-4080, FAX: (504) 885-1439  
EMAIL: mail@ecmconsultants.com

OWNER:  
HOUSING AUTHORITY  
OF NEW ORLEANS  
2051 SENATE ST. BUILDING B, RM. 202  
NEW ORLEANS, LOUISIANA 70122

PROJECT:  
GUSTE III COMMUNITY  
INTERIOR & EXTERIOR REPAIRS  
SHEET TITLE:  
EXTERIOR IMPROVEMENTS

DRAWN K.A.
CHECKED N.G.W.
DATE JUN. 21, 2024
SCALE AS SHOWN
JOB NO. 22462.14
SHEET NO.

C-019

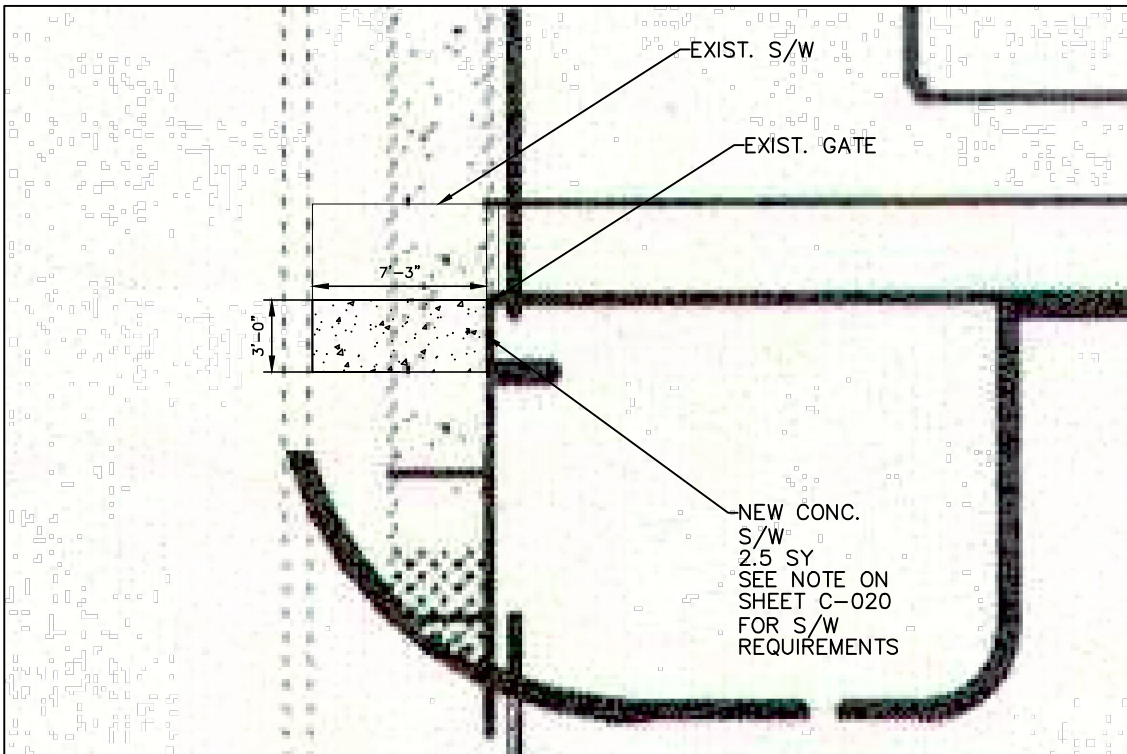

11 & 14  
SCALE: 1/4" = 1'-0" C-001 | C-020

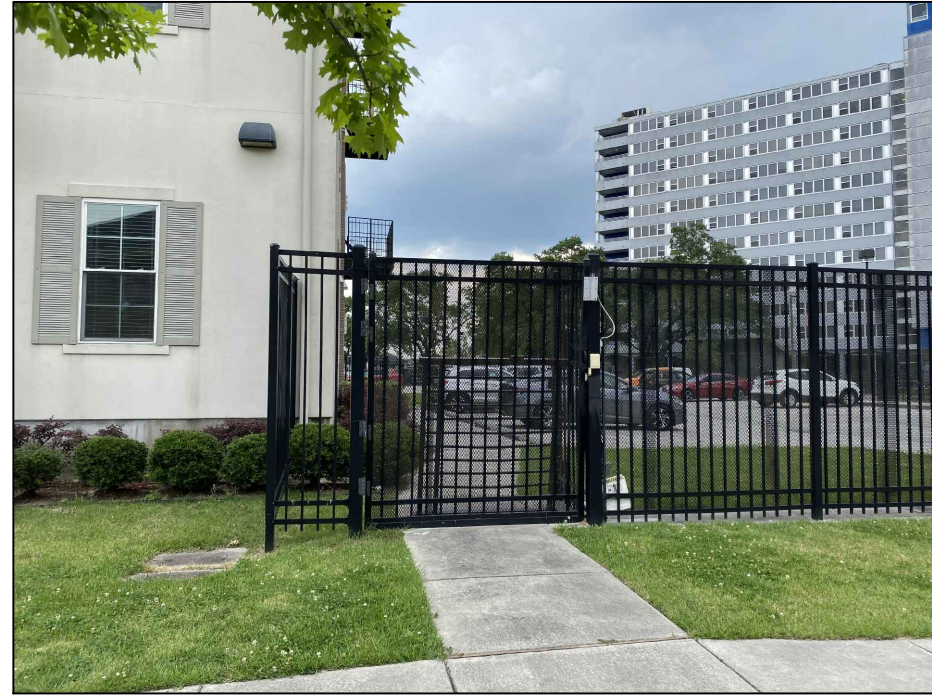

11 & 14  
N.T.S

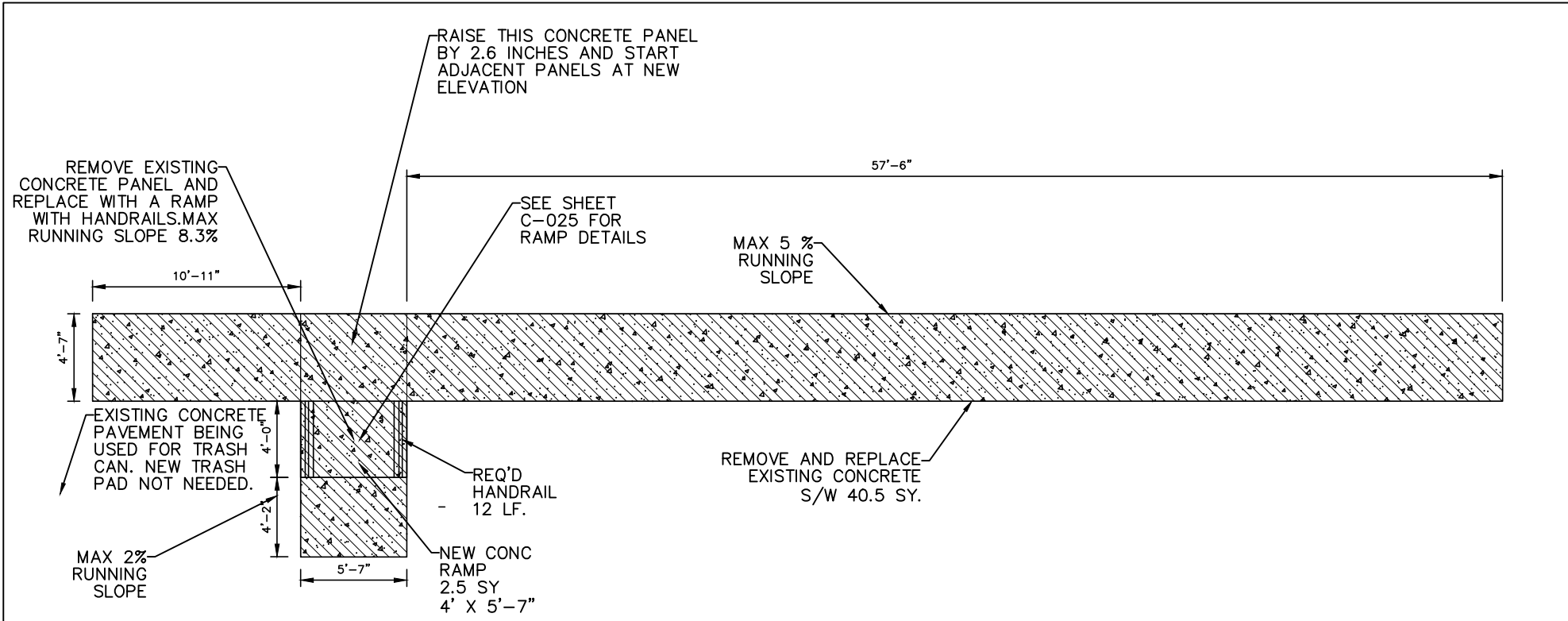

12 B  
SCALE: 1/4" = 1'-0" C-001 | C-020

NOTE:  
1. CLEAR EXTENSION OF ATLEAST 18 INCHES IS REQUIRED ON THE LATCH SIDE AT THE GATE. THE CLEAR SPACE MUST ALSO EXTEND 60" FROM THE GATE..

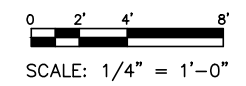

REVISIONS	BY

ARCHITECT/ENGINEER:  
**ECM Consultants, Inc.**  
ENGINEERS - ARCHITECTS - CONSTRUCTION MANAGERS  
1301 CLEARVIEW PKWY. SUITE 200  
METAIRIE, LOUISIANA 70001  
PHONE: (504) 885-4080. FAX: (504) 885-1439  
EMAIL: mail@ecmconsultants.com

OWNER:  
HOUSING AUTHORITY  
OF NEW ORLEANS  
2051 SENATE ST. BUILDING B, RM. 202  
NEW ORLEANS, LOUISIANA 70122

PROJECT:  
GUSTE III COMMUNITY  
INTERIOR & EXTERIOR REPAIRS  
SHEET TITLE:  
EXTERIOR IMPROVEMENTS

DRAWN  
K.A.  
CHECKED  
N.G.W.  
DATE  
JUN. 21, 2024  
SCALE  
AS SHOWN  
JOB NO.  
22462.14  
SHEET NO.

C-020



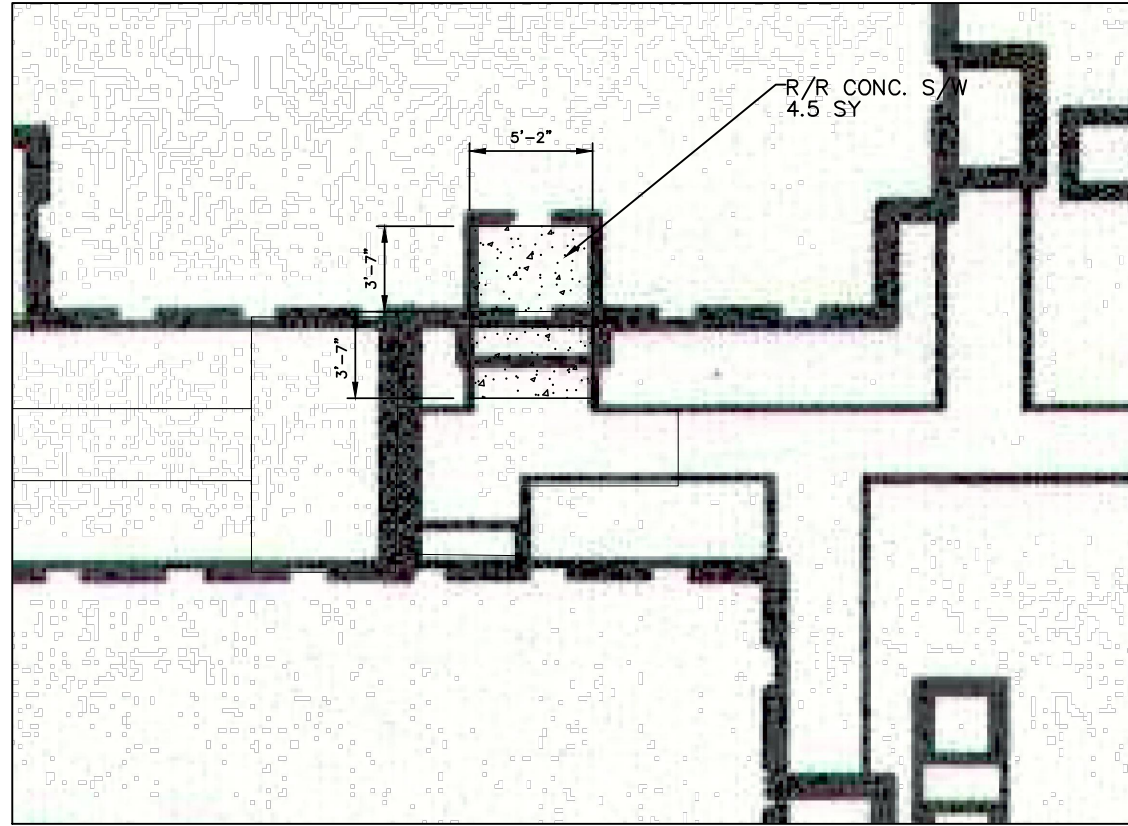

12 C  
SCALE: 1/4" = 1'-0" C-001 | C-021



12 C  
SCALE: N.T.S

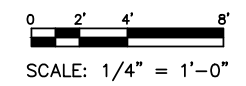

REVISIONS	BY

ARCHITECT/ENGINEER:  
**ECM Consultants, Inc.**  
ENGINEERS - ARCHITECTS - CONSTRUCTION MANAGERS  
1301 CLEARVIEW PKWY. SUITE 200  
METAIRIE, LOUISIANA 70001  
PHONE: (504) 885-4080. FAX: (504) 885-1439  
EMAIL: mail@ecmconsultants.com

OWNER:  
HOUSING AUTHORITY  
OF NEW ORLEANS  
2051 SENATE ST. BUILDING B. RM. 202  
NEW ORLEANS, LOUISIANA 70122

PROJECT:  
GUSTE III COMMUNITY  
INTERIOR & EXTERIOR REPAIRS  
SHEET TITLE:  
EXTERIOR IMPROVEMENTS

DRAWN K.A.
CHECKED N.G.W.
DATE JUN. 21, 2024
SCALE AS SHOWN
JOB NO. 22462.14
SHEET NO.

C-021



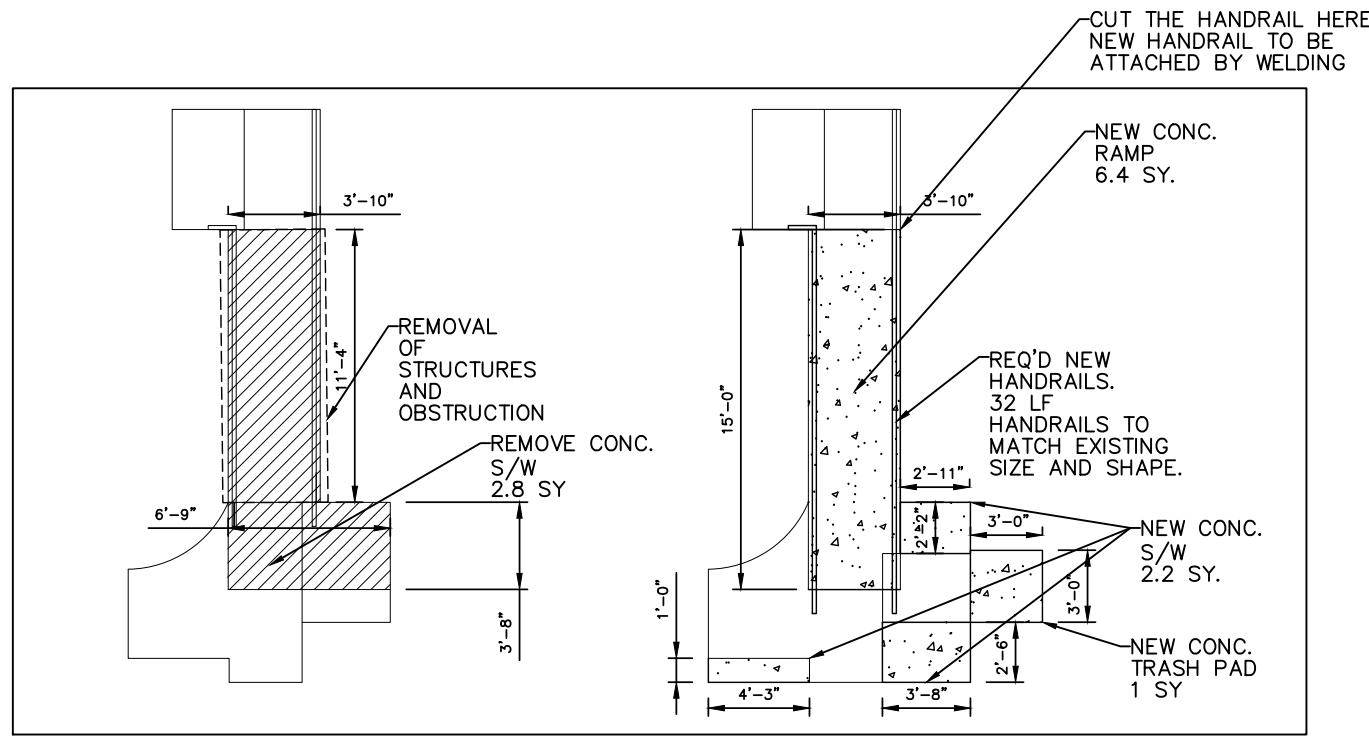

**2408 ERATO RAMP**  
SCALE: 1/4" = 1'-0" C-001 C-022

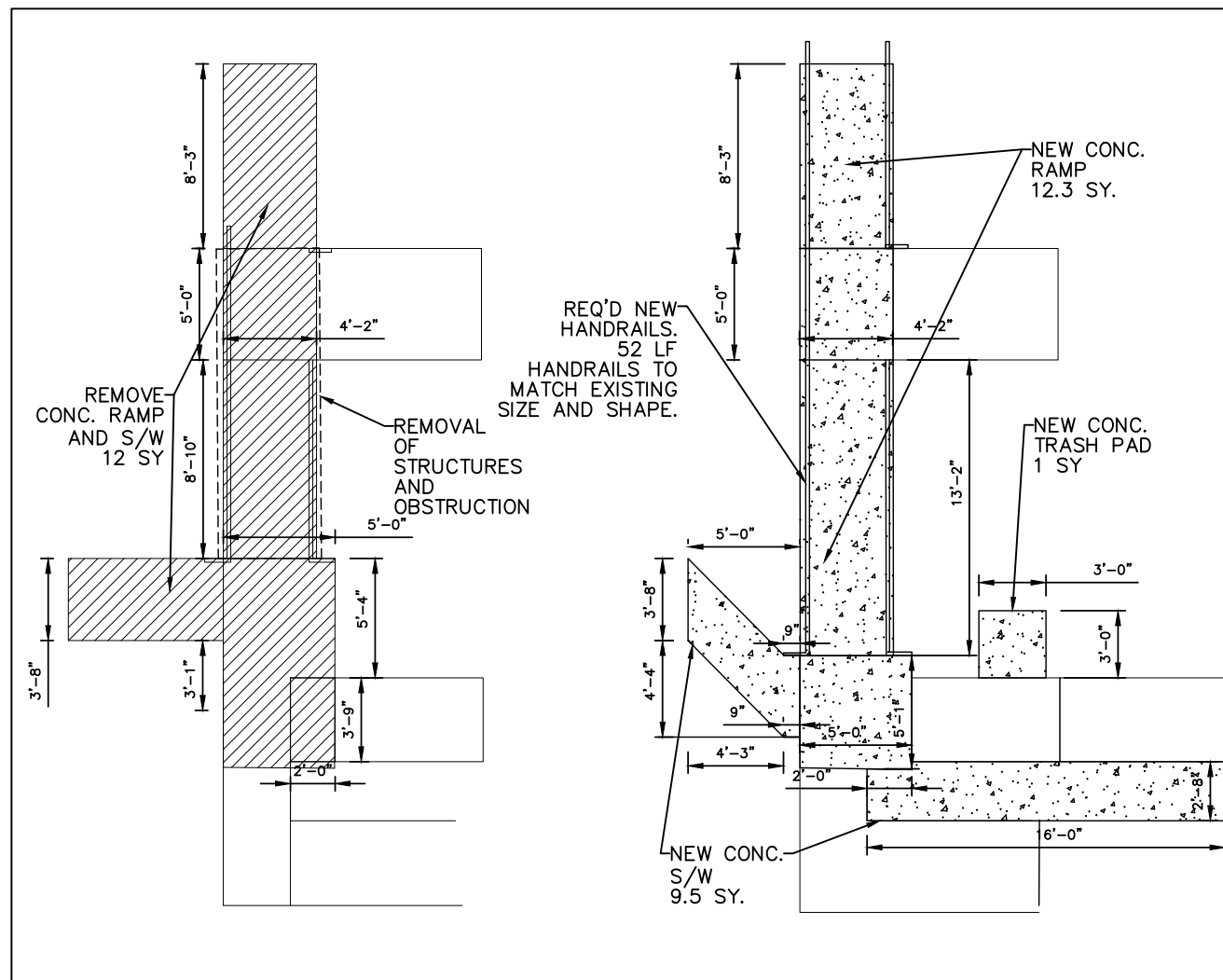

**2414 ERATO RAMP**  
SCALE: 1/4" = 1'-0" C-001 C-022

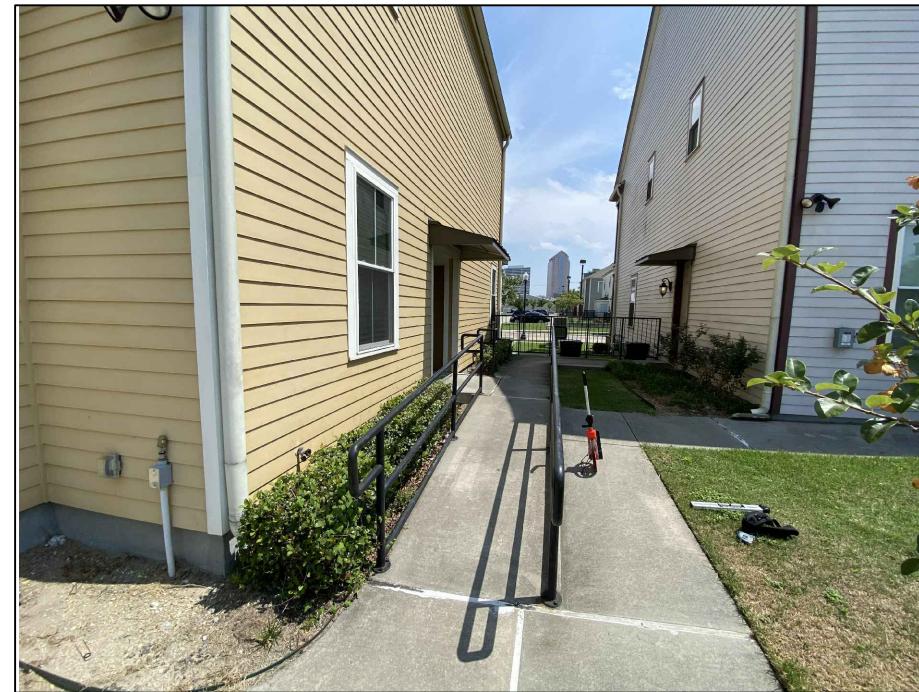

**2408 ERATO RAMP**  
N.T.S

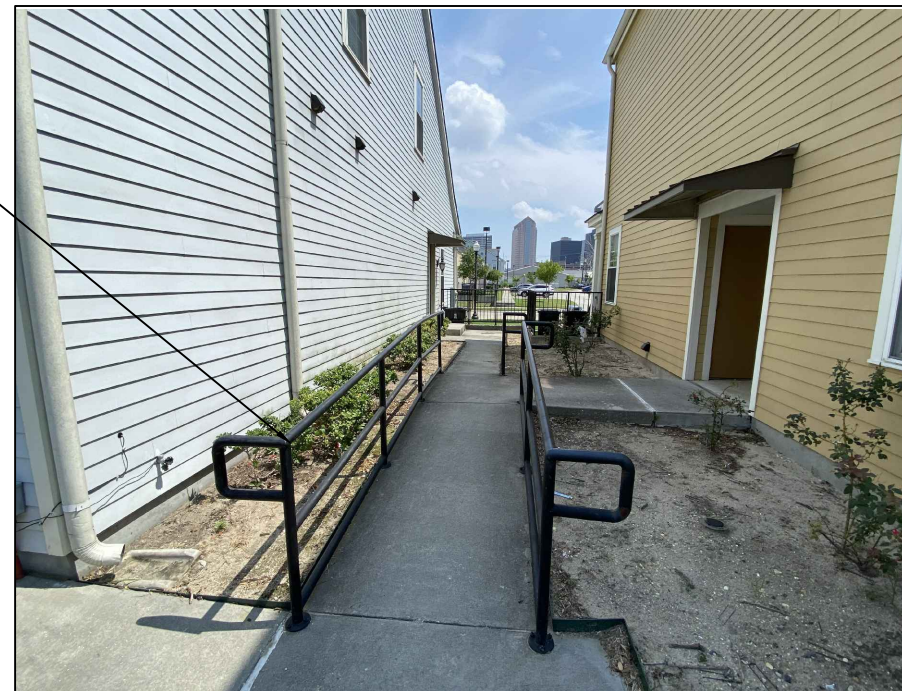

**2414 ERATO RAMP**  
N.T.S

0 2' 4' 8'  
SCALE: 1/4" = 1'-0"



REVISIONS	BY

ARCHITECT/ENGINEER:  
**ECM Consultants, Inc.**  
ENGINEERS - ARCHITECTS - CONSTRUCTION MANAGERS  
1301 CLEARVIEW PKWY. SUITE 200  
METAIRIE, LOUISIANA 70001  
PHONE: (504) 885-4080, FAX: (504) 885-1439  
EMAIL: mail@ecmconsultants.com

OWNER:  
HOUSING AUTHORITY  
OF NEW ORLEANS  
2051 SENATE ST. BUILDING B, RM. 202  
NEW ORLEANS, LOUISIANA 70122

PROJECT:  
GUSTE III COMMUNITY  
INTERIOR & EXTERIOR REPAIRS  
SHEET TITLE:  
ACCESSIBLE ROUTES IMPROVEMENTS

DRAWN	K.A.
CHECKED	N.G.W.
DATE	JUN. 21, 2024
SCALE	AS SHOWN
JOB NO.	22462.14
SHEET NO.	C-022

C-022

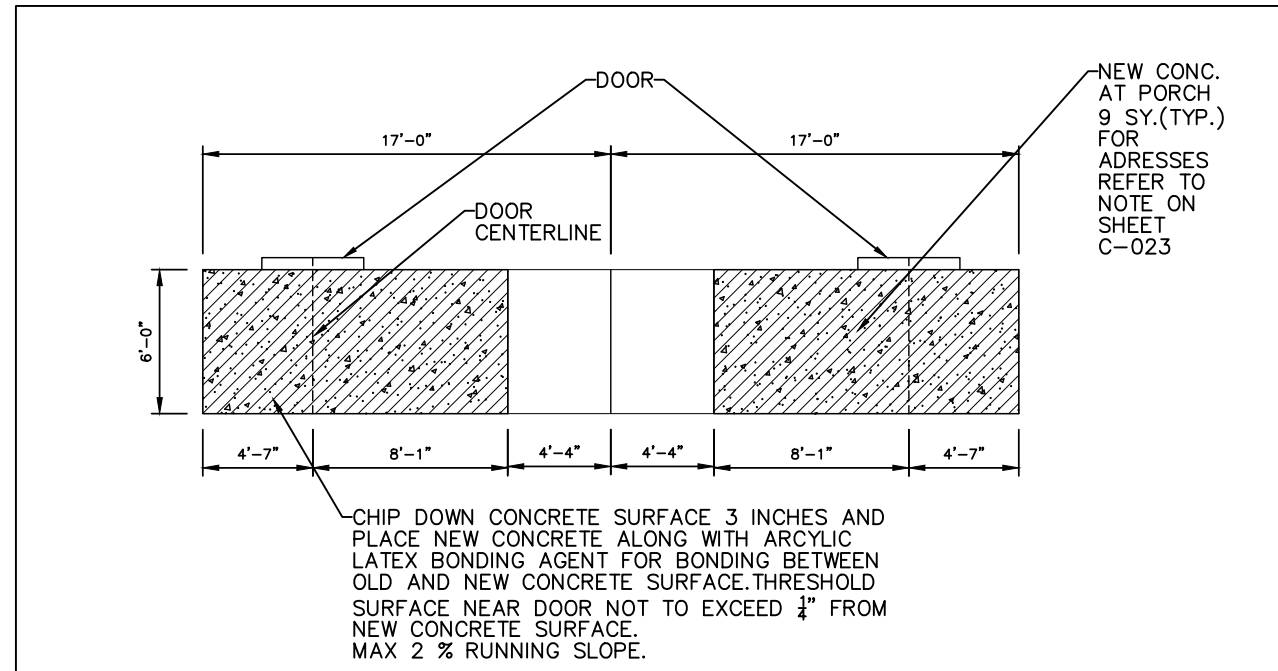

16

SCALE: 1/4" = 1'-0"

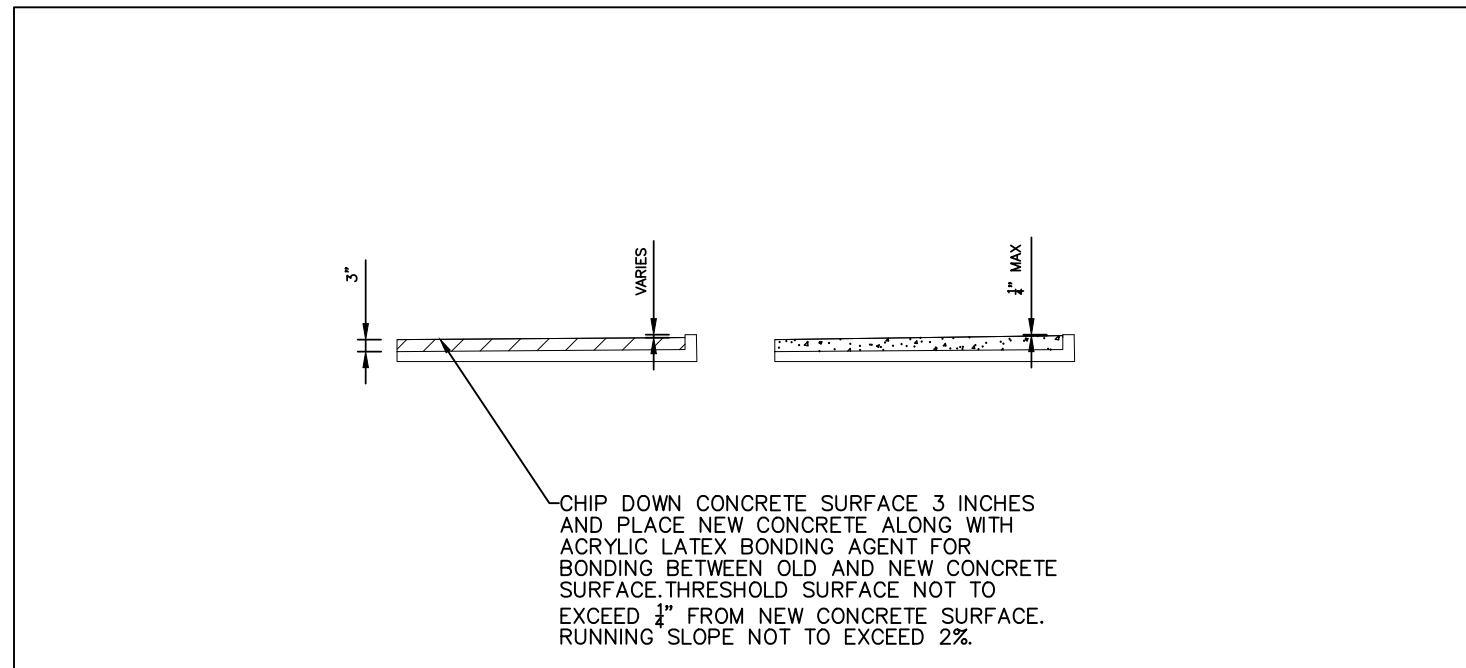

16

SCALE: 1/2" = 1'-0"

NOTE:

FOLLOWING ARE THE ADDRESSES WHERE THIS REPAIR AT FRONT PORCH NEEDS TO BE PERFORMED:

1. 1210 REV JOHN RAPHAEL JR WAY
2. 1212 REV JOHN RAPHAEL JR WAY
3. 1215 REV JOHN RAPHAEL JR WAY
4. 1217 REV JOHN RAPHAEL JR WAY
5. 1222 REV JOHN RAPHAEL JR WAY
6. 1224 REV JOHN RAPHAEL JR WAY
7. 1215 S. LIBERTY STREET
8. 1217 S. LIBERTY STREET
9. 2410 ERATO STREET
10. 2412 ERATO STREET
11. 2306 ERATO STREET
12. 2308 ERATO STREET
13. 2322 ERATO STREET
14. 2324 ERATO STREET
15. 1202 FRERET STREET
16. 1204 FRERET STREET

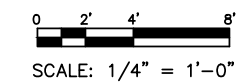
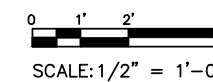

REVISIONS	BY

ARCHITECT/ENGINEER:  
**ECM Consultants, Inc.**  
 ENGINEERS - ARCHITECTS - CONSTRUCTION MANAGERS  
 1301 CLEARVIEW PKWY. SUITE 200  
 METAIRIE, LOUISIANA 70001  
 PHONE: (504) 885-4080, FAX: (504) 885-1439  
 EMAIL: mail@ecmconsultants.com

OWNER:  
 HOUSING AUTHORITY  
 OF NEW ORLEANS  
 2051 SENATE ST. BUILDING B, RM. 202  
 NEW ORLEANS, LOUISIANA 70122

PROJECT:  
 GUSTE III COMMUNITY  
 INTERIOR & EXTERIOR REPAIRS  
 SHEET TITLE:  
 EXTERIOR IMPROVEMENTS

DRAWN K.A.
CHECKED N.G.W.
DATE JUN. 21, 2024
SCALE AS SHOWN
JOB NO. 22462.14
SHEET NO.

C-023

REVISIONS	BY

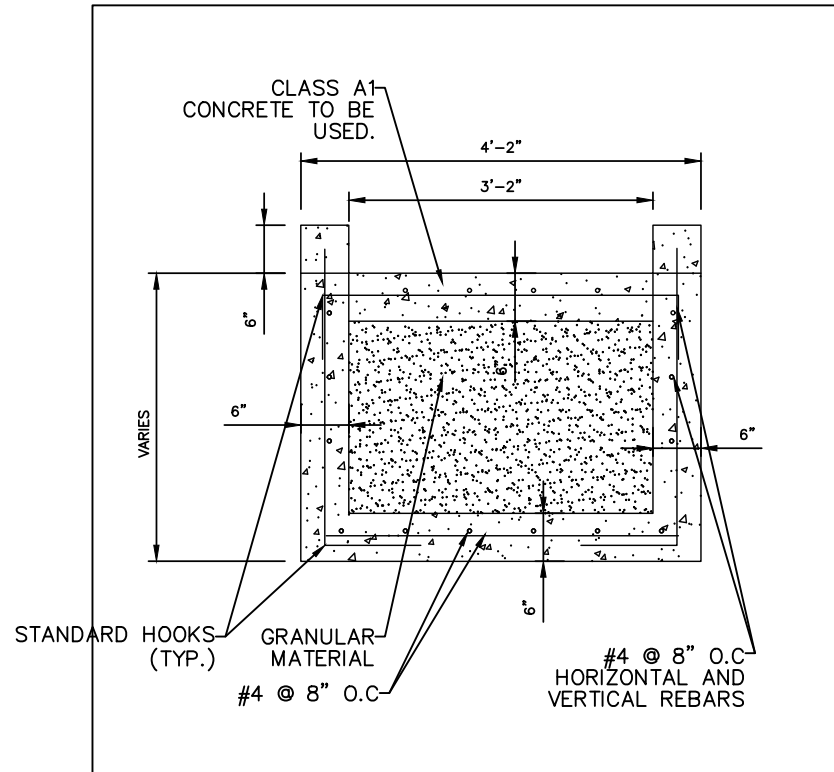

RAMP SECTION DETAIL 1

SCALE: 1" = 1'-0"

1  
C-003A  
C-004A  
C-005A  
C-006A  
C-024

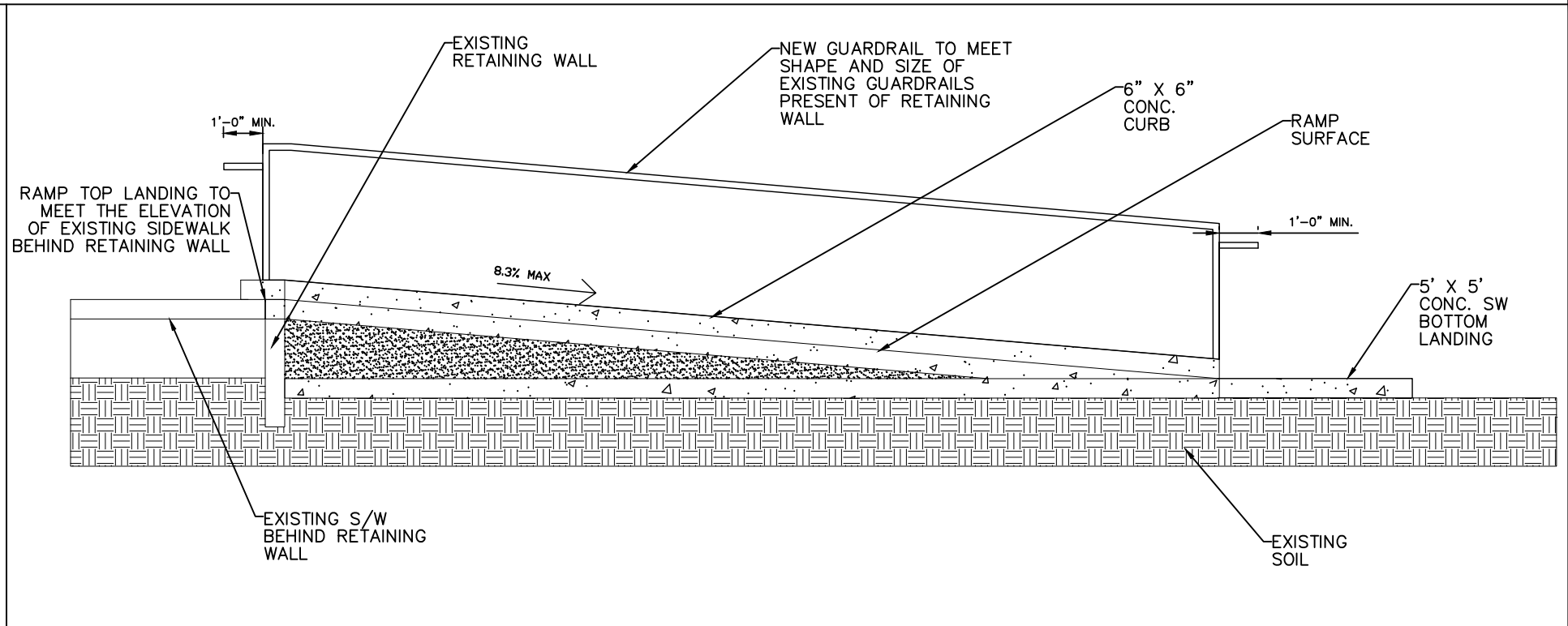

RAMP SECTION DETAIL 2

SCALE: 1/2" = 1'-0"

2  
C-003A  
C-004A  
C-005A  
C-006A  
C-024

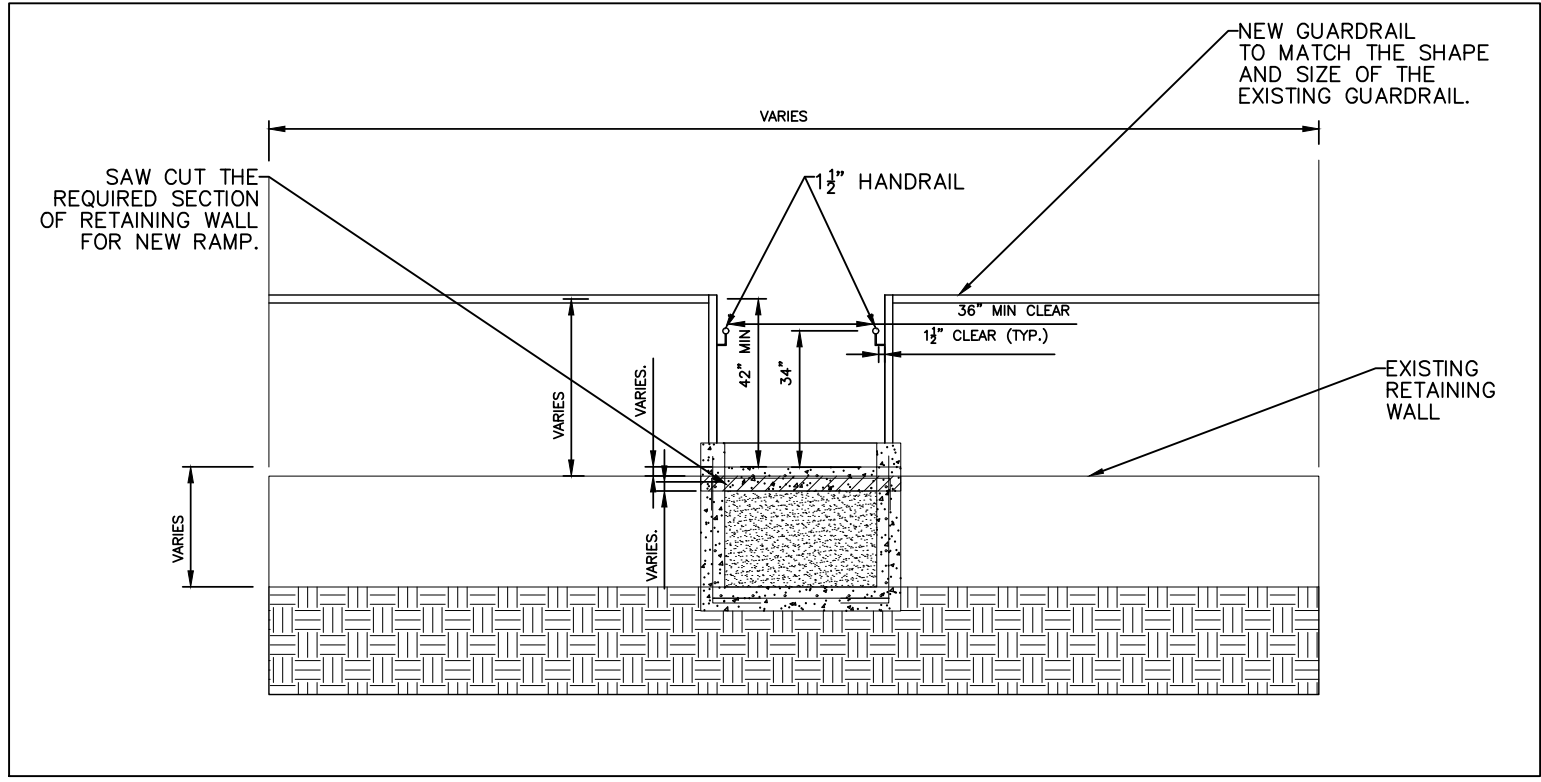

RAMP SECTION ELEVATION @ RETAINING WALL

SCALE: 1/2" = 1'-0"

1  
C-024 | C-024

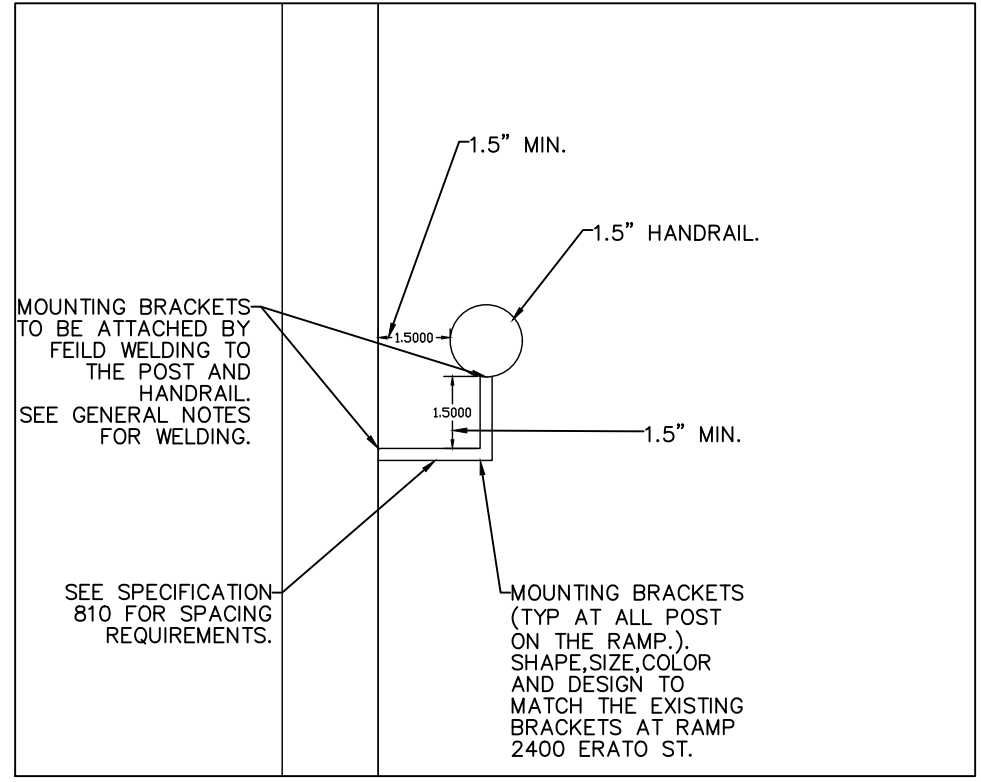

MOUNTING BRACKETS TYPICAL DETAIL

SCALE: 6" = 1'-0"

C-024 | C-024

ARCHITECT/ENGINEER:  
**ECM Consultants, Inc.**  
ENGINEERS - ARCHITECTS - CONSTRUCTION MANAGERS  
1301 CLEARVIEW PKWY. SUITE 200  
METAIRIE, LOUISIANA 70001  
PHONE: (504) 885-4080, FAX: (504) 885-1439  
EMAIL: mail@ecmconsultants.com

OWNER:  
HOUSING AUTHORITY  
OF NEW ORLEANS  
2051 SENATE ST. BUILDING B, RM. 202  
NEW ORLEANS, LOUISIANA 70122

PROJECT:  
GUSTE III COMMUNITY  
INTERIOR & EXTERIOR REPAIRS  
SHEET TITLE:  
RAMP DETAILS

DRAWN  
K.A.  
CHECKED  
N.G.W.  
DATE  
JUN. 21, 2024  
SCALE  
AS SHOWN  
JOB NO.  
22462.14  
SHEET NO.

C-024

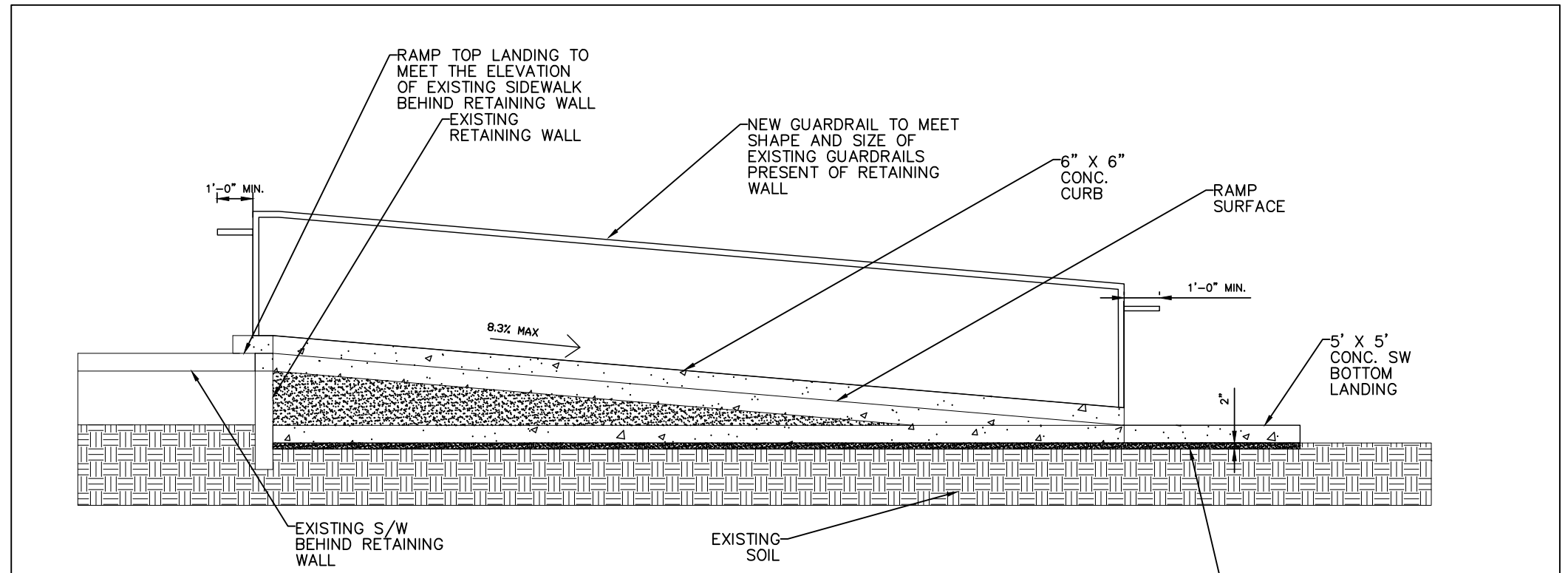

RAMP SECTION DETAIL 2 2  
 SCALE: 1/2" = 1'-0" C-002A/C-024A

2" ADDITIONAL GRANULAR MATERIAL TO RAISE THE NATURAL GROUND ELEVATION BY 2 INCHES BEFORE THE CONSTRUCTION OF RAMP.

REVISIONS	BY

ARCHITECT/ENGINEER:  
**ECM Consultants, Inc.**  
 ENGINEERS - ARCHITECTS - CONSTRUCTION MANAGERS  
 1301 CLEARVIEW PKWY. SUITE 200  
 METAIRIE, LOUISIANA 70001  
 PHONE: (504) 885-4080, FAX: (504) 885-1439  
 EMAIL: mail@ecmconsultants.com

OWNER:  
 HOUSING AUTHORITY  
 OF NEW ORLEANS  
 2051 SENATE ST. BUILDING B, RM. 202  
 NEW ORLEANS, LOUISIANA 70122

PROJECT:  
 GUSTE III COMMUNITY  
 INTERIOR & EXTERIOR REPAIRS  
 SHEET TITLE:  
 RAMP DETAILS

DRAWN K.A.
CHECKED N.G.W.
DATE JUN. 21, 2024
SCALE AS SHOWN
JOB NO. 22462.14
SHEET NO. 

C-024A

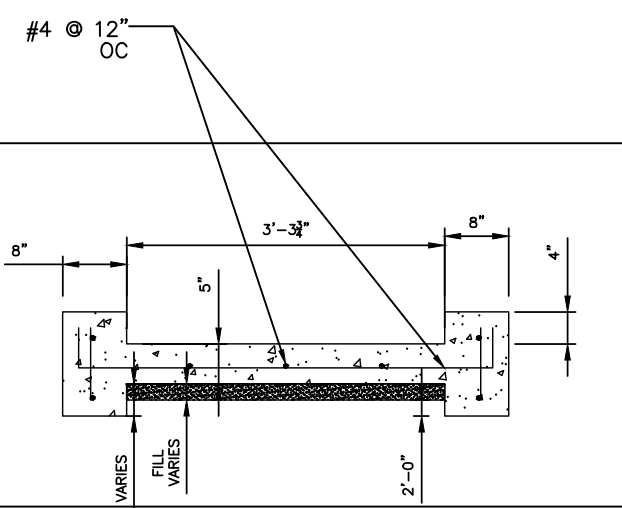

RAMP DETAIL 3  
SCALE: 1" = 1'-0" C-016 | C-025

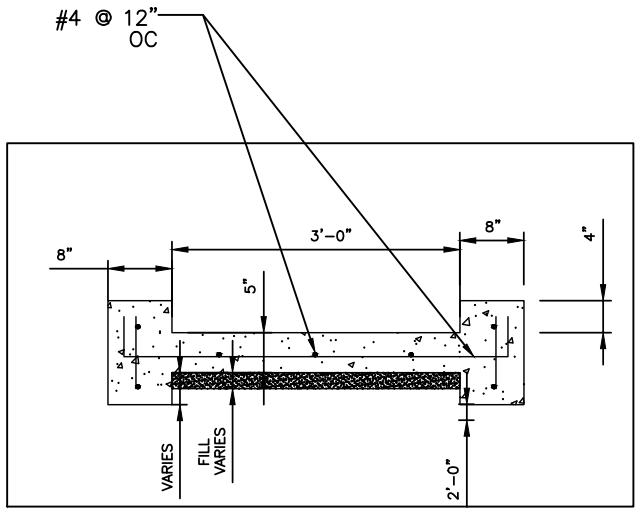

RAMP DETAIL 4  
SCALE: 1" = 1'-0" C-017 | C-025

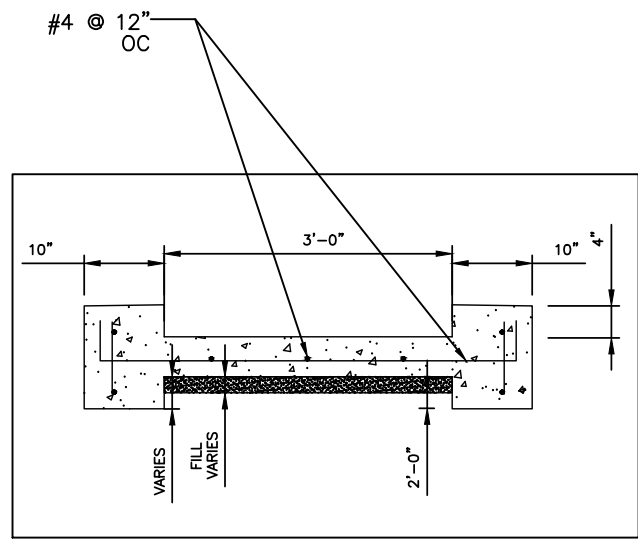

RAMP DETAIL 5  
SCALE: 1/4" = 1'-0" C-017 | C-025

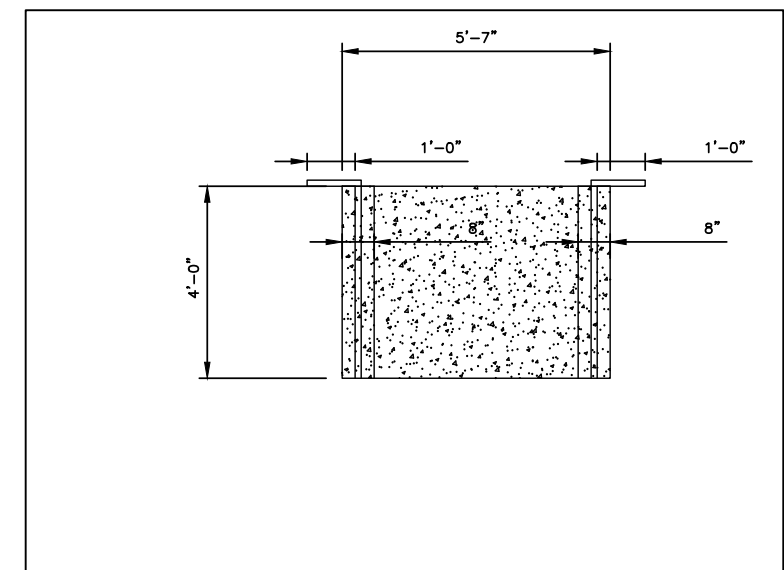

12 B RAMP PLAN  
SCALE: 1/2" = 1'-0" C-020 | C-025

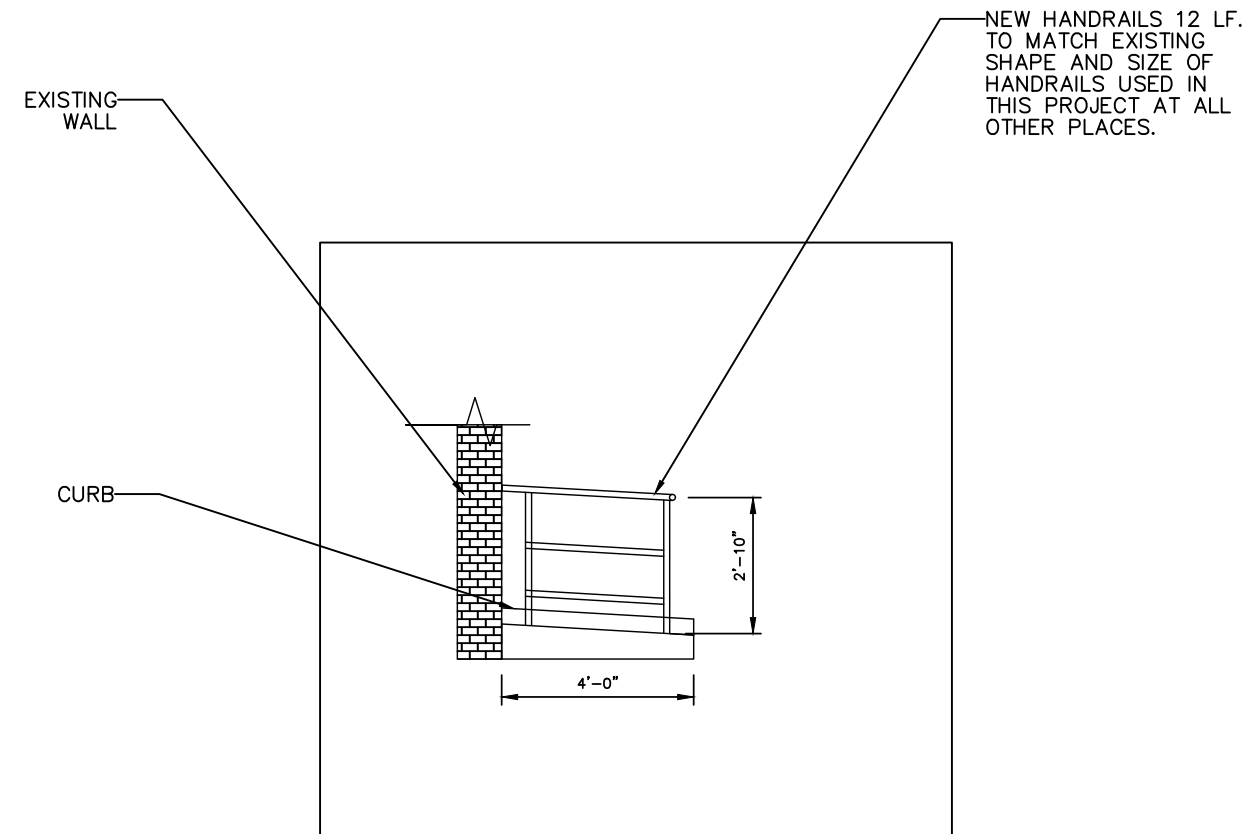

12 B RAMP ELEVATION  
SCALE: 1/2" = 1'-0" C-016 | C-025

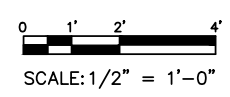

REVISIONS	BY

ARCHITECT/ENGINEER:  
**ECM Consultants, Inc.**  
 ENGINEERS - ARCHITECTS - CONSTRUCTION MANAGERS  
 1301 CLEARVIEW PKWY. SUITE 200  
 METAIRIE, LOUISIANA 70001  
 PHONE: (504) 885-4080, FAX: (504) 885-1439  
 EMAIL: mail@ecmconsultants.com

OWNER:  
 HOUSING AUTHORITY  
 OF NEW ORLEANS  
 2051 SENATE ST. BUILDING B, RM. 202  
 NEW ORLEANS, LOUISIANA 70122

PROJECT:  
 GUSTE III COMMUNITY  
 INTERIOR & EXTERIOR REPAIRS  
 SHEET TITLE:  
 RAMP DETAILS

DRAWN  
 K.A.  
 CHECKED  
 N.G.W.  
 DATE  
 JUN. 21, 2024  
 SCALE  
 AS SHOWN  
 JOB NO.  
 22462.14  
 SHEET NO.

C-025



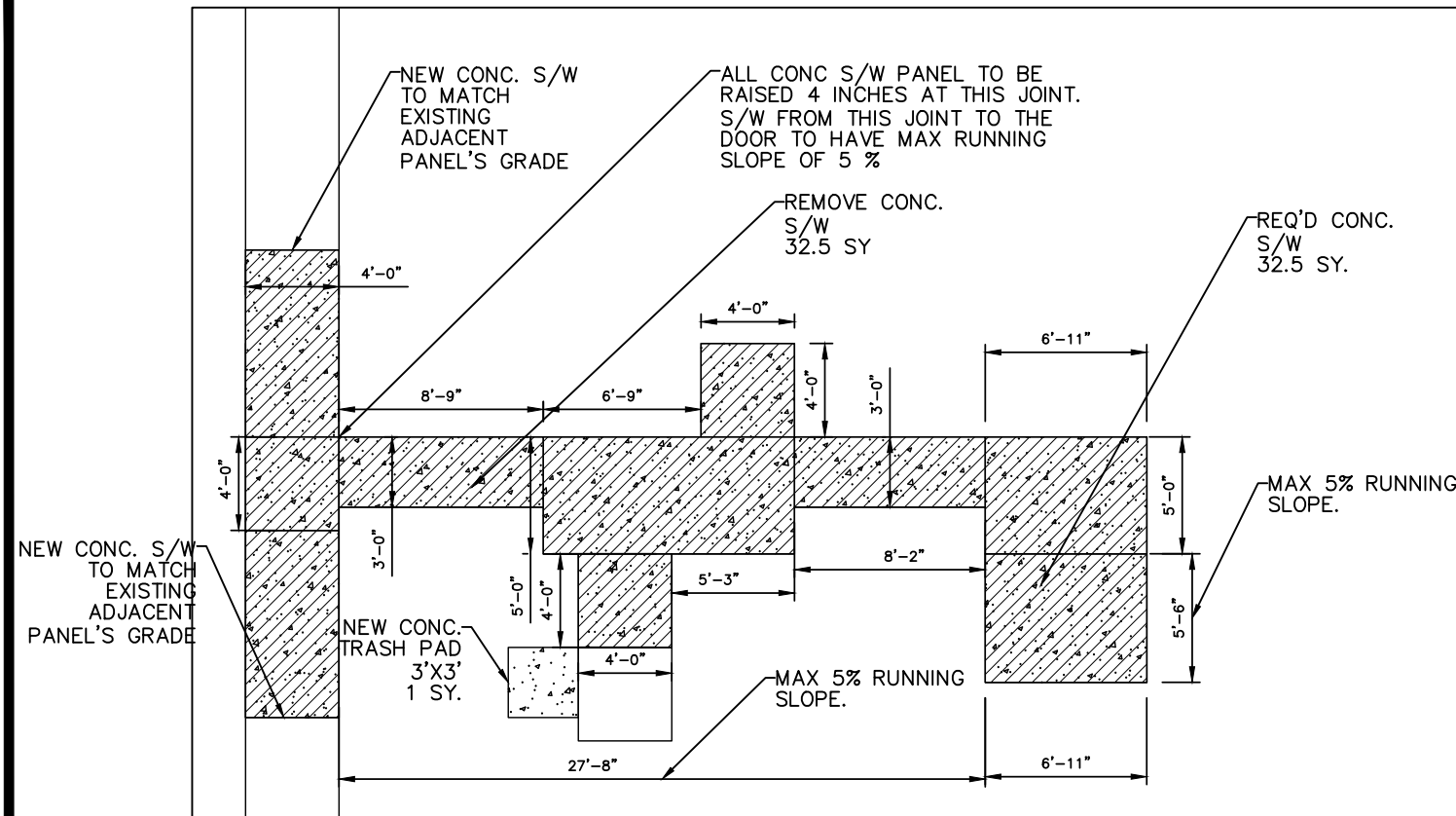

1213 S LIBERTY  
SCALE: 1/4" = 1'-0" C-001 | C-022

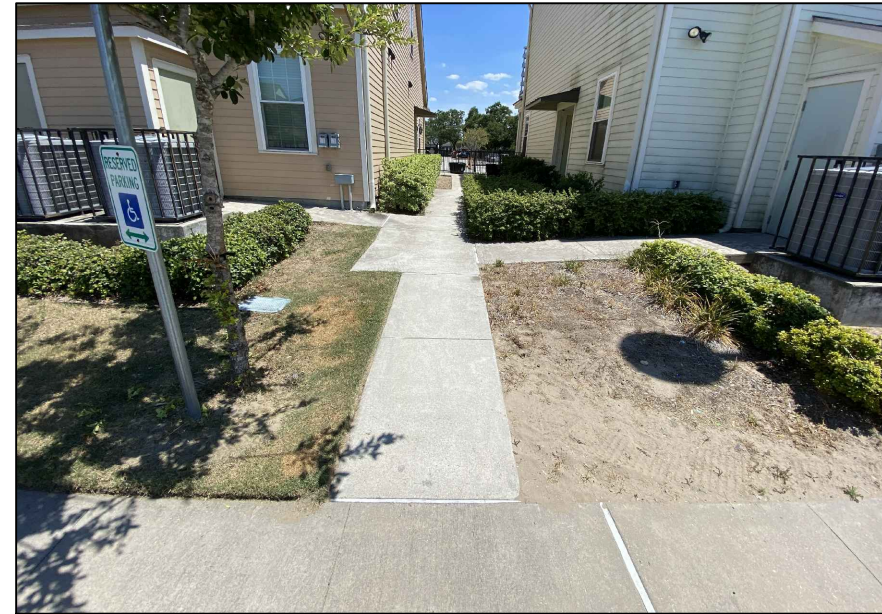

1213 S LIBERTY

N.T.S

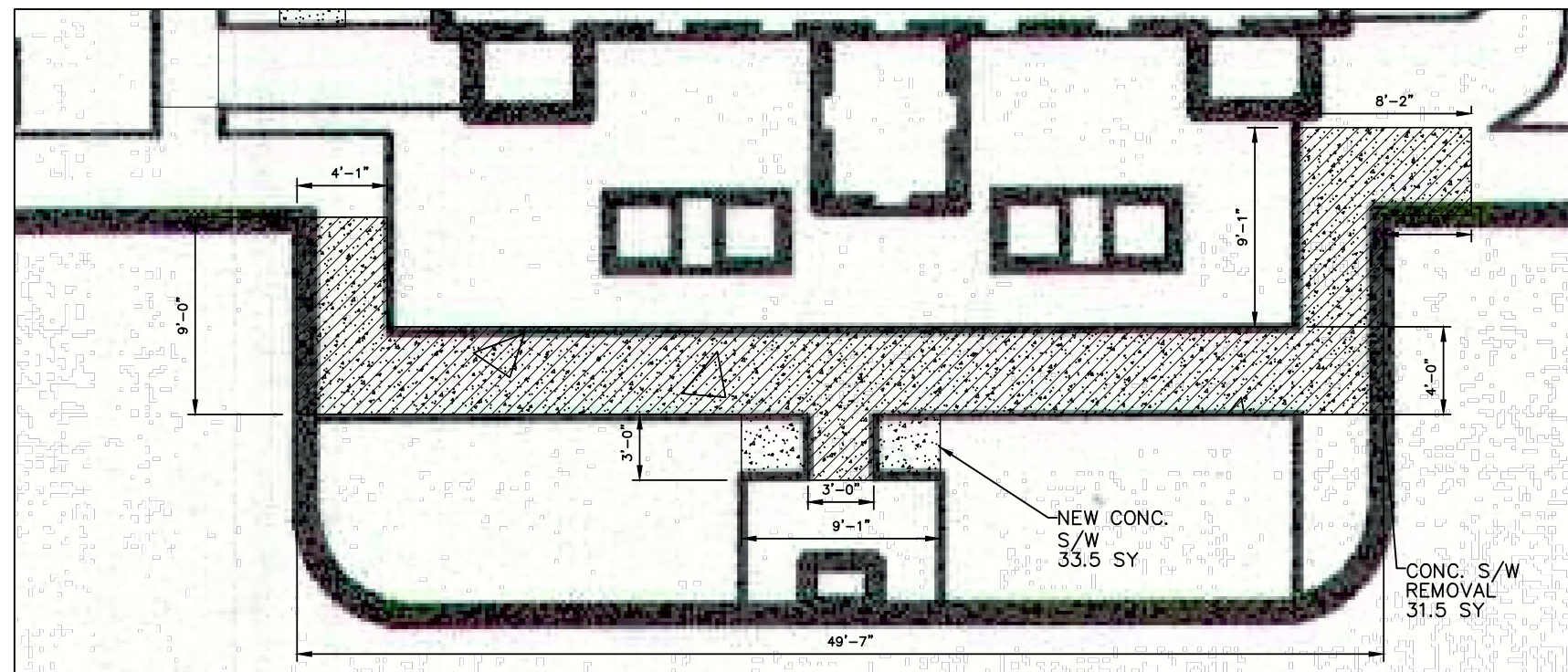

2400 MAIL CENTRE  
SCALE: 1/4" = 1'-0" C-001 | C-026



REVISIONS	BY

ARCHITECT/ENGINEER:  
**ECM Consultants, Inc.**  
ENGINEERS - ARCHITECTS - CONSTRUCTION MANAGERS  
1301 CLEARVIEW PKWY. SUITE 200  
METAIRIE, LOUISIANA 70001  
PHONE: (504) 885-4080, FAX: (504) 885-1439  
EMAIL: mail@ecmconsultants.com

OWNER:  
HOUSING AUTHORITY  
OF NEW ORLEANS  
2051 SENATE ST. BUILDING B, RM. 202  
NEW ORLEANS, LOUISIANA 70122

PROJECT:  
GUSTE III COMMUNITY  
INTERIOR & EXTERIOR REPAIRS  
SHEET TITLE:  
EXTERIOR IMPROVEMENTS

DRAWN K.A.
CHECKED N.G.W.
DATE JUN. 21, 2024
SCALE AS SHOWN
JOB NO. 22462.14
SHEET NO.

C-026



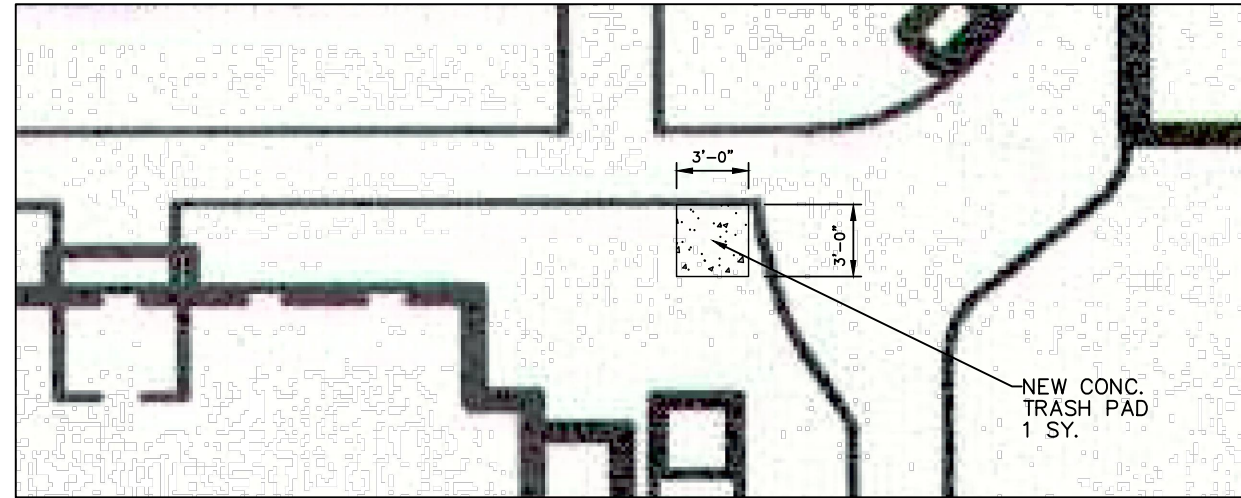

1220 RJR WAY  
SCALE: 1/4" = 1'-0" C-001 | C-027

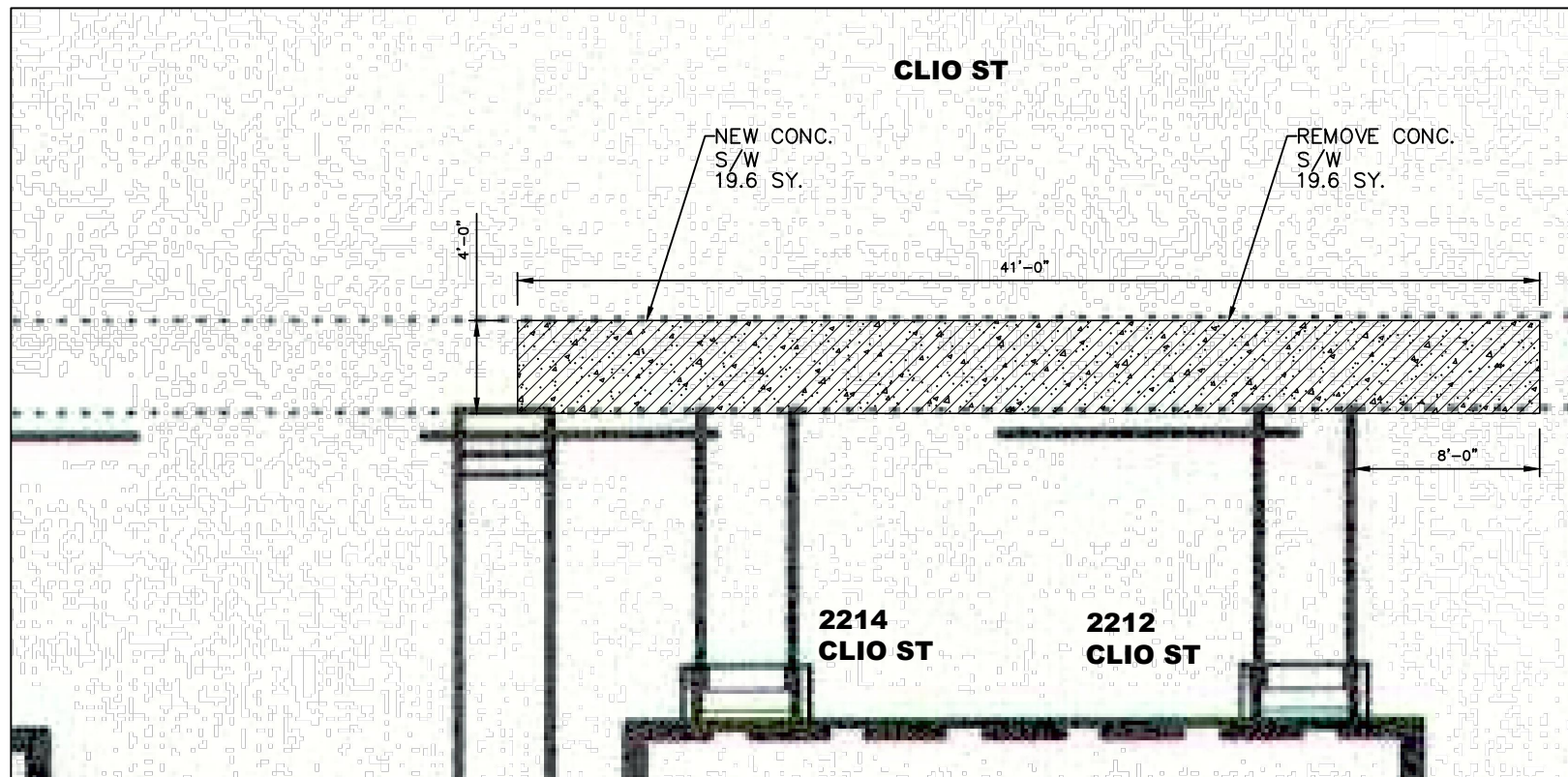

2212 CLIO ST  
SCALE: 1/4" = 1'-0" C-001 | C-027



2212 CLIO ST  
SCALE: 1/4" = 1'-0" C-001 | C-027

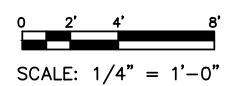

REVISIONS	BY

ARCHITECT/ENGINEER:  
**ECM Consultants, Inc.**  
ENGINEERS - ARCHITECTS - CONSTRUCTION MANAGERS  
1301 CLEARVIEW PKWY. SUITE 200  
METAIRIE, LOUISIANA 70001  
PHONE: (504) 885-4080. FAX: (504) 885-1439  
EMAIL: mail@ecmconsultants.com

OWNER:  
HOUSING AUTHORITY  
OF NEW ORLEANS  
2051 SENATE ST. BUILDING B. RM. 202  
NEW ORLEANS, LOUISIANA 70122

PROJECT:  
GUSTE III COMMUNITY  
INTERIOR & EXTERIOR REPAIRS  
SHEET TITLE:  
EXTERIOR IMPROVEMENTS

DRAWN	K.A.
CHECKED	N.G.W.
DATE	JUN. 21, 2024
SCALE	AS SHOWN
JOB NO.	22462.14
SHEET NO.	

C-027



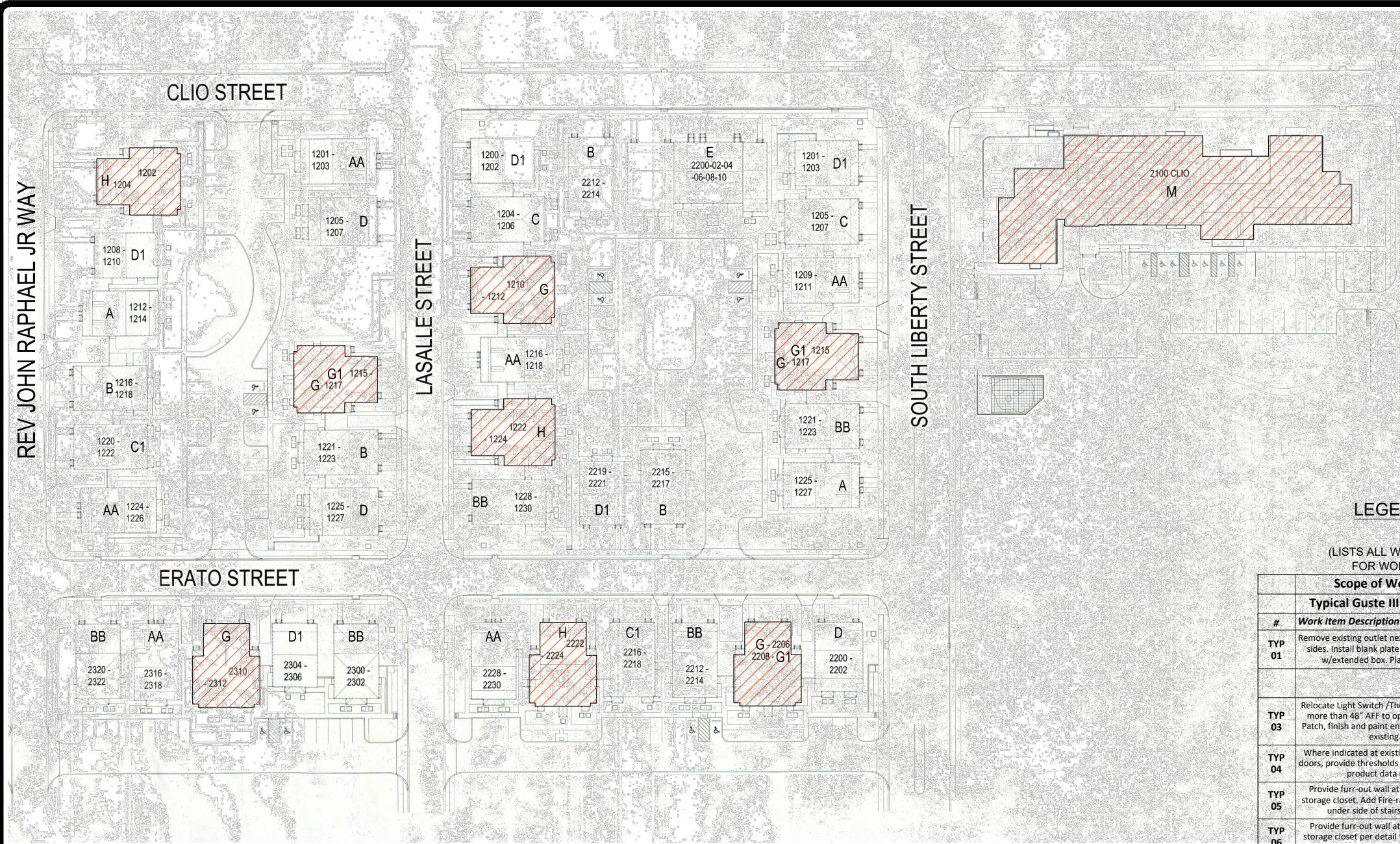

1  
A-100

**OVERALL SITE PLAN**

SCALE: N.T.S.



**LEGEND**

INDICATES BUILDING UNITS TO BE REPAIRED

**APPLIANCE LIST FOR GUSTE:**

PROVIDE THE FOLLOWING APPLIANCES IN EACH UNIT; OR APPROVED EQUAL:

- SUMMIT APPLIANCE - WEM 210 40"H X 30"W X 24"D - SLIDE-IN STYLE RANGE
- BROAN 30" WHITE RANGE HOOD NON VENTED WITH POWER CORD. MGF #BUEZ130WW
- GE 24" BUILT-IN 3-CYCLE DISHWASHER MGF #GDT225SGLWW
- WHIRLPOOL 20 CU. FT. TOP FREEZER REFRIGERATOR MGF #WRT311FZDW
- WHIRLPOOL 21 CU. FT. SIDE-BY-SIDE REFRIGERATOR MGF #WRS331SDHM
- GE 1.6 CU. FT. COUNTERTOP MICROWAVE OVEN MGF #JES1657DMWW
- GE 4.5 CU. FT. FRONT LOAD WASHING MACHINE (120 VOLT) MGF #GFW510SCNWW
- GE 7.8 CU. FT. ELECTRIC DRYER, 240 VOLT, 6 CYCLES MGF #GFD55ESSNWW

(NOTE: ONLY 1 REFRIGERATOR PER UNIT)

**LEGEND OF SCOPE OF WORK SHEETS (FOR INTERIOR ONLY)**

(LISTS ALL WORK ITEMS THAT ARE TO BE PERFORMED IN THE UNITS. FOR WORK IN SPECIFIC UNITS, SEE SHEETS A-120 TO A-130.)

#	Scope of Work for Typical Guste III Unit Work Work Item Description	Guste III Housing Development		
		Unit	Quantity	Reference Notes Typical Interior Units Rpt #
TYP 01	Remove existing outlet next to range at both sides. Install blank plate. Relocate outlet w/extended box. Plate per code.	Ea		See Photos 4, 5 & 8 on sheet A-143. Outlets to be 36" from corner. # 55, 64
TYP 03	Relocate Light Switch / Thermostat to be no more than 48" AFF to operating devices. Patch, finish and paint entire wall to match existing.	Ea		Relocate thermostat to 48" to operating buttons per sht G-003. #25, 29, 31, 34, 41, 54, 65
TYP 04	Where indicated at existing entry/balcony doors, provide thresholds as indicated in the product data notes.	Ea		Refer to Product Data Notes #2 & #3 for type of threshold. #32, 37, 42, 43, 51
TYP 05	Provide furr-out wall at rear of exterior storage closet. Add Fire-rated gyp board to under side of stairs per detail.	LS		Refer Product Data Notes #1, A & B on sheet A-141 for details. # 52
TYP 06	Provide furr-out wall at rear of interior storage closet per detail to make depth of closet no more than 24".	LS		Refer Product Data Note #1 on sheet A-141 for similar details. #48, 53, 63
TYP 07	Remove existing tub & tub surround at entry bath. Install blocking in wall for future grab bars. Install new tub & surround as detailed.	LS		Refer to Product Data Note #7 for type of tub/tub surround. #26, 30, 35, 39, 44, 46, 57
TYP 08	Remove Toilet. Provide offset flange or reroute piping to move toilet to be 18" from centerline of toilet. Patch ceramic floor tile as required.	Ea		See Scope of Work Unit Sheets #27, 36, 58
TYP 09	Remove existing balcony door. Install new door as described and detailed in drawings.	LS		Refer to details 4, 5 & C on sheet A-141 for balcony door details. # 24
TYP 10	Remove Lav and Vanity Cabinet. Provide new lav, faucet & vanity to locate center of lav to be no less than 15" from sidewall. Replace cultured marble countertop.	LS		Refer to Product Data Note #6 for type of items to provide. # 28, 47
TYP 11	Lower elec panelboard to make top most operable is at 48" AFF.	LS		See Report #31a. # 31a
TYP 12	Remove existing kitchen sink. Replace with new sink to match existing shape and size with drain at rear for knee space.	LS		Reroute piping for knee access. Provide slanted panel per Detail #1 on sheet A-141. # 31b
TYP 13	Remove braces under Lav Counter. Modify brace at wall for knee clearance. Reinstall open end brace to be 30" clear.	LS		# 31c
TYP 14	Remove existing grab bars. Install new grab bars meeting code.	EA		See sheet G-003 for grab bar spacing. # 31d
TYP 15	Remove to reinstall toilet tissue holder. Per code. Patch wall and paint.	EA		See sheet G-003 for toilet tissue requirements. # 31e & f
TYP 16	Remove to reinstall shower controls and piping to meet code. Patch existing tub surround as req'd.	EA		See Report #31g for direction. # 31g

**SEQUENCING AND PHASING OF THE WORK:**

CONTRACTOR TO NOTE THAT THE MAJORITY OF THE INTERIOR REPAIRS WILL BE PERFORMED WITHIN OCCUPIED UNITS. CONTRACTOR SHALL SCHEDULE THE WORK WITHIN EACH UNIT TO ALLOW FOR THE CURRENT TENANT TO REMAIN IN THE UNIT. PLUMBING FACILITIES THAT ARE REQUIRED TO BE REPAIRED SHALL BE SCHEDULED TO ALLOW AT LEAST ONE BATHROOM ACCESSIBLE TO THE TENANT AT ALL TIMES DURING THE REPAIRS WITHIN THE UNIT. TEMPORARY BARRIERS SHALL BE USED TO PROTECT AND PREVENT THE TENANTS FROM IMPACTING THE ON-GOING WORK. THE CONTRACTOR SHALL SCHEDULE THE WORK TO SPEND THE MINIMUM AMOUNT OF TIME WITHIN EACH UNIT. WORKERS SHALL BE AVAILABLE AT ALL TIMES WHEN WORK HAS BEGUN WITHIN A UNIT AND SHALL PERFORM THE REQUIRED WORK AS QUICKLY AS POSSIBLE. THE CONTRACTOR SHALL PROVIDE ENOUGH PERSONNEL TO WORK ON A MINIMUM OF 3 TO 5 UNITS AT ONE TIME. WORK WITHIN A UNIT SHALL TAKE A MINIMUM OF 5 TO 10 WORKING DAYS. THE 1ST PHASE OF THE WORK WILL BE PERFORMED IN VACANT UNITS. THESE VACANT UNITS ARE: M-BUILDING UNITS - #106, 308, & 406. GUSTE III UNITS - 2410 ERATO & 1210 REV JOHN RAPHAEL JR WAY.

CONTRACTOR SHALL COMPLETE ALL WORK WITHIN A UNIT BEFORE STARTING ON THE NEXT SET OF UNITS. EACH UNIT SHALL BE INSPECTED TO CONFIRM WORK IS COMPLETE WITHIN EACH UNIT. THESE INSPECTIONS WILL ONLY BE PERFORMED AFTER THE WEEKLY PROGRESS MEETING HELD AT THE SITE. ONCE ALL UNITS OF THE PHASE HAS BEEN ACCEPTED BY THE OWNER AND A/E, THE CONTRACTOR CAN BEGIN WORK ON THE NEXT SET OF UNITS. THE CONTRACTOR SHALL SUBMIT PRIOR TO THE START OF THE WORK A SEQUENCING/PHASING SCHEDULE IDENTIFYING THE TIME EACH UNIT IN THE FACILITY WILL BE OCCUPIED BY THE WORKERS, IN ORDER TO INFORM THE TENANTS. THIS SCHEDULE WILL BE CONTINUALLY UPDATED THROUGHOUT THE COURSE OF THE WORK TO KEEP MANAGEMENT AND TENANTS UPDATED TO THE SCHEDULE.

AT ALL TIMES THROUGHOUT THE PROJECT, THE CONTRACTOR SHALL MAINTAIN A PROJECT MANAGER AND PROJECT SUPERINTENDENT ON SITE DURING THE COURSE OF THE PROJECT. NO CHANGES IN THE PERSONNEL SHALL OCCUR WITHOUT APPROVAL BY THE OWNER.

REVISIONS	BY

**ECM Consultants, Inc.**  
 ARCHITECTS - CONSTRUCTION MANAGERS  
 ENGINEERS - ARCHITECTS - CONSTRUCTION MANAGERS  
 1301 CLEARVIEW PKWY. SUITE 200  
 METAIRIE, LOUISIANA 70001  
 PHONE: (504) 885-4080. FAX: (504) 885-1439  
 EMAIL: mail@ecmconsultants.com

OWNER:  
 HOUSING AUTHORITY  
 OF NEW ORLEANS  
 2051 SENATE ST. BUILDING B, RM. 202  
 NEW ORLEANS, LOUISIANA 70122

PROJECT:  
 GUSTE III COMMUNITY  
 INTERIOR & EXTERIOR REPAIRS  
 SHEET TITLE:  
 OVERALL SITE PLAN

DRAWN  
 M.L.M. & A.E.D.  
 CHECKED  
 N.G.W.  
 DATE  
 JUN. 21, 2024  
 SCALE  
 AS SHOWN  
 JOB NO.  
 22462.14  
 SHEET NO.



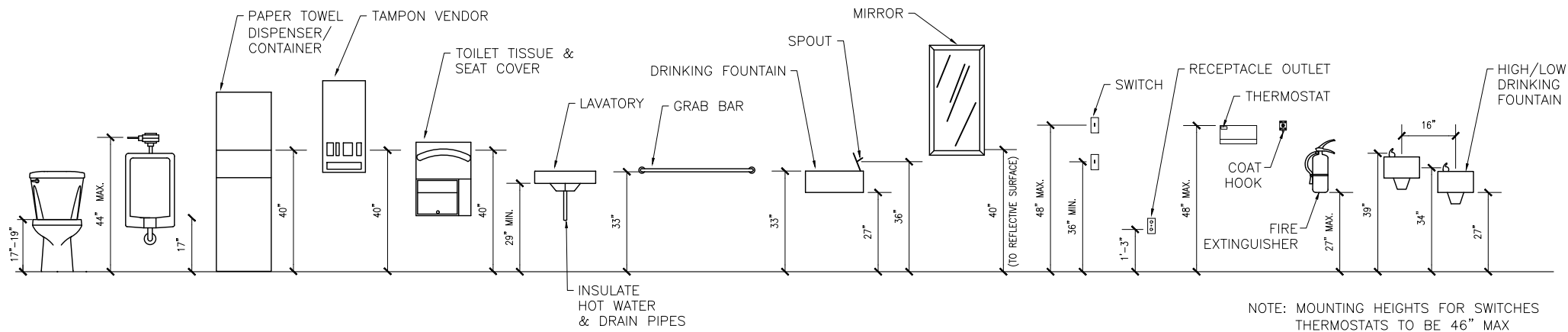

**MOUNTING HEIGHTS**

NOTE: MOUNTING HEIGHTS FOR SWITCHES THERMOSTATS TO BE 46\"/>

**TOILET ROOMS, FEATURES, AND ACCESSORIES**

1. ALL PUBLIC AND COMMON USE TOILET ROOMS MUST BE ACCESSIBLE. PRIVATE TOILET ROOMS OFF A PRIVATE OFFICE MUST BE ADAPTABLE.
2. AT LEAST ONE TYPE OF EACH FIXTURE & ACCESSORY MUST BE ACCESSIBLE: PROVIDE PATH TO ACCESSIBLE FIXTURE.
3. TURNING SPACE: 60 IN. DIAMETER OR 5x5 FT I-SHAPE.
4. WHERE 6 OR MORE TOILET STALLS ARE PROVIDED IN ADDITION TO THE STANDARD 5x5 FT WHEEL CHAIR STALL, AT LEAST ONE STALL MUST BE 36 IN. WIDE WITH GRAB BARS ON BOTH SIDES.
5. STALL DOORS MAY NOT SWING INTO CLEAR FLOOR SPACE REQ'D FOR FIXTURES, IN STANDARD STALLS, THE FRONT PARTITION AND AT LEAST ONE SIDE PARTITION MUST PROVIDE A TOE CLEARANCE OF 9 IN. ABOVE FINISH FLOOR (AFF) IF STALL DEPTH IS GREATER THAN 60 IN. TOE CLEARANCE NOT REQ'D.
6. FLUSH, LAVATORY, AND ACCESSORY CONTROLS: OPERABLE WITH ONE HAND: NO LIGHT GRASPING, PINCHING, OR TWISTING OF WRIST: 5 LBS MAX, 44 IN. AFF MAX: AUTOMATIC IS OKAY. TOILET FLUSH CONTROLS TO BE MOUNTED ON WIDE SIDE OF TOILET AREA.
7. HOT WATER AND DRAINPIPPES UNDER LAVATORIES MUST BE INSULATED OR OTHERWISE CONFIGURED TO PROTECT AGAINST CONTACT. NO SHARP OR ABRASIVE SURFACES UNDER LAVATORIES.
8. TOILET PAPER DISPENSERS THAT CONTROL DELIVERY OR DO NOT PERMIT CONTINUOUS FLOW MAY NOT BE USED.
9. FOR PAPER TOWEL AND OTHER DISPENSERS AND DISPOSALS, SEE "REACH DIMENSIONS FROM A WHEELCHAIR" INFORMATION.
10. COORDINATE ADAAS WITH STATE AND LOCAL CODE REQUIREMENTS.
11. ALL DIMENSIONS ARE FOR ADULT USE FACILITIES.

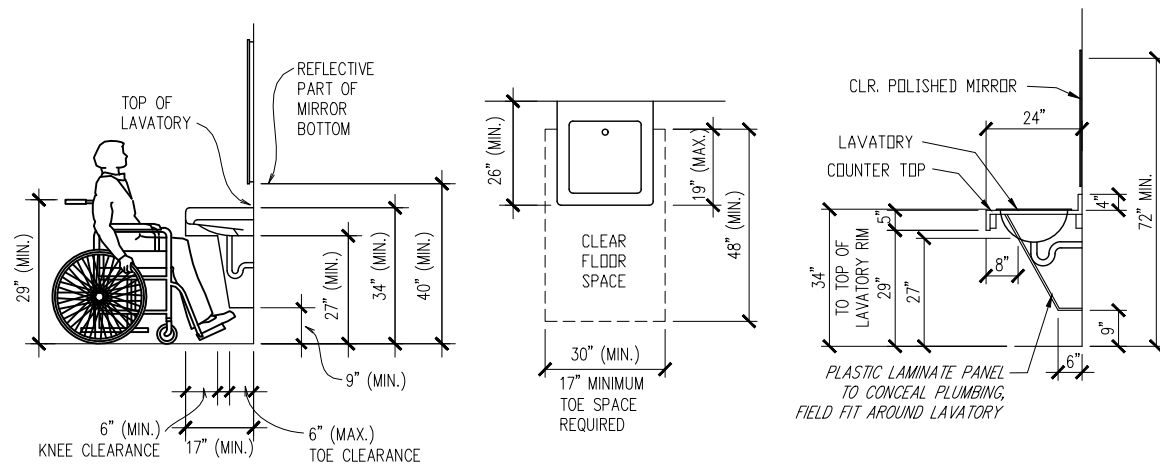

**HANDICAPPED LAVATORY DETAILS**

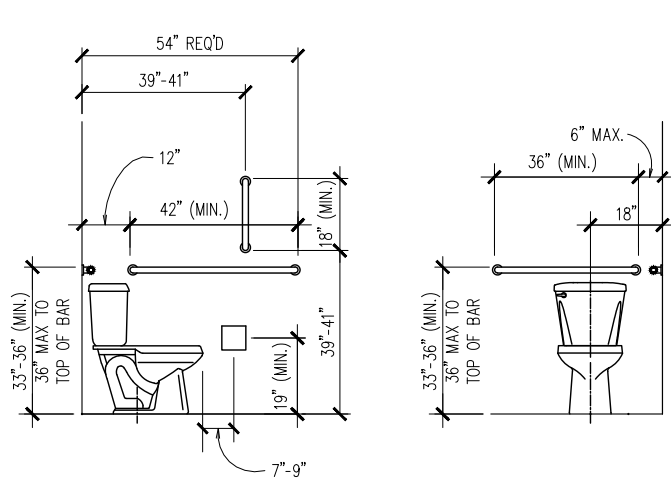

**HANDICAPPED TOILET DETAILS**

(FLUSH LEVER ON OPEN SIDE OF TOILET)

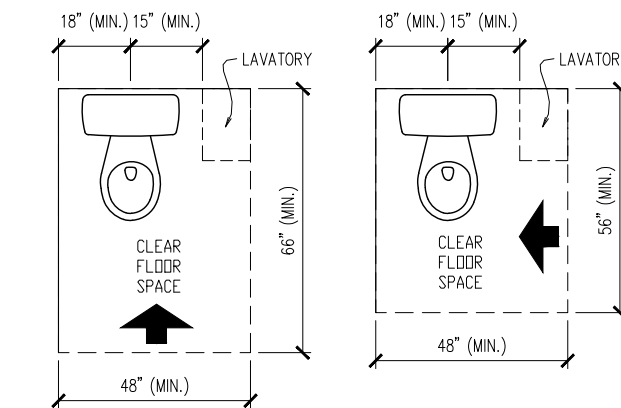

**ACCESSIBLE TOILET ROOM DETAILS**

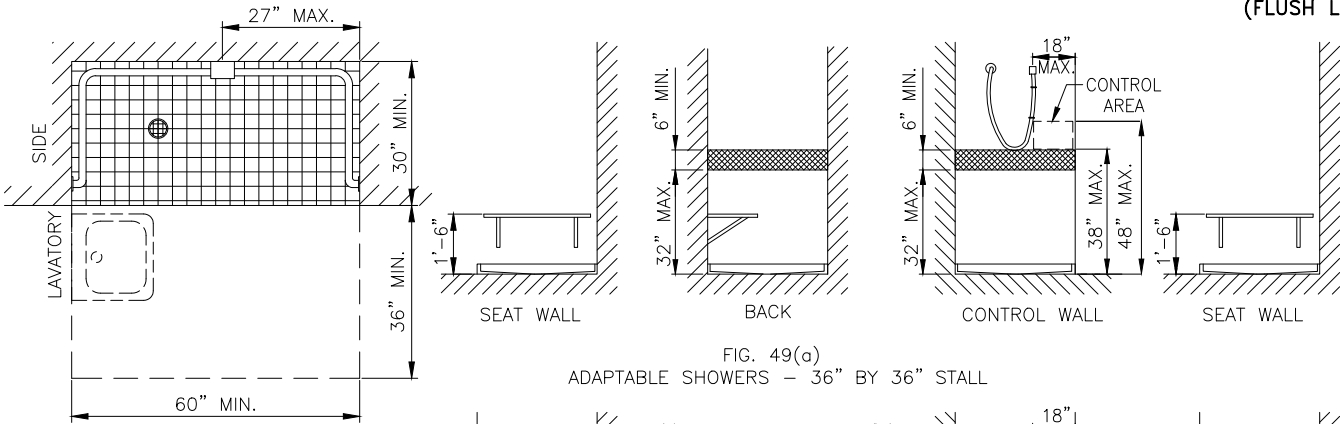

**SHOWER SIZE & CLEARANCES**

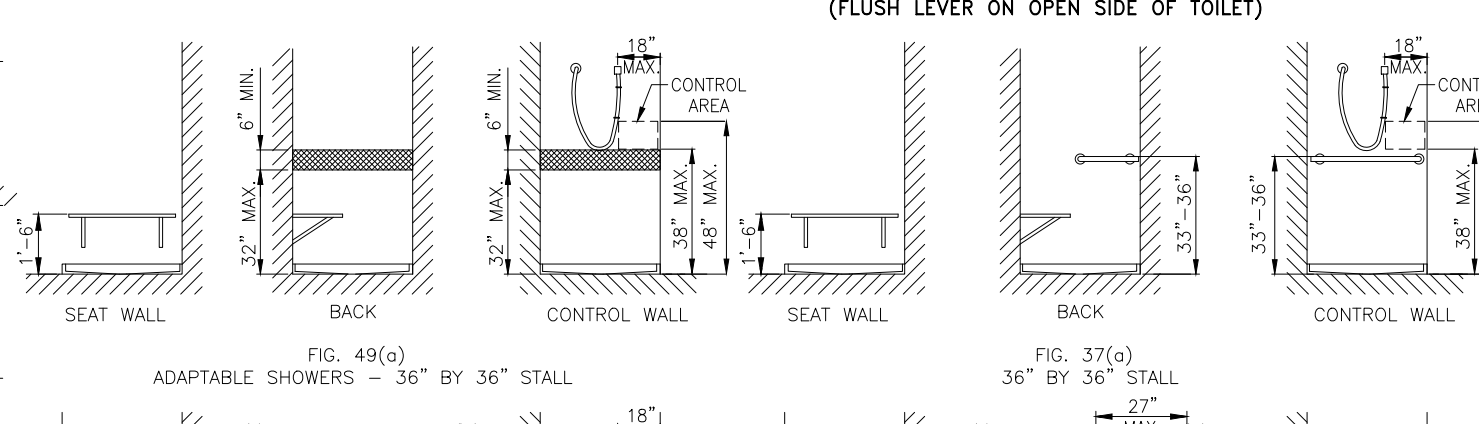

**LOCATION OF GRAB BARS & CONTROLS**

NOTE: THE HATCHED AREAS ARE WHERE CONTRACTOR IS TO PROVIDE WOOD BLOCKING IN WALLS FOR GRAB BARS.

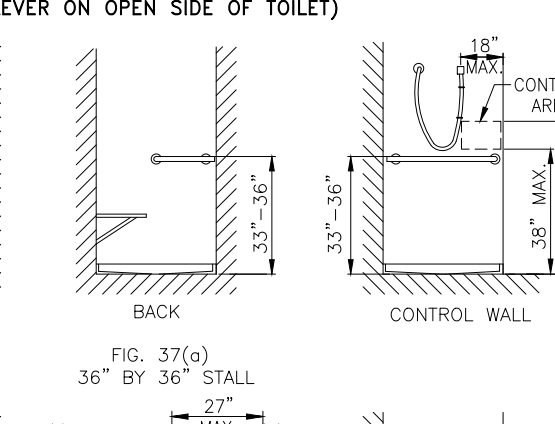

**GRAB BARS AT SHOWER STALLS**

NOTE: SHOWERHEAD & CONTROL AREA MAY BE ON BACK (LONG) WALL (AS SHOWN) OR ON EITHER SIDE WALL.

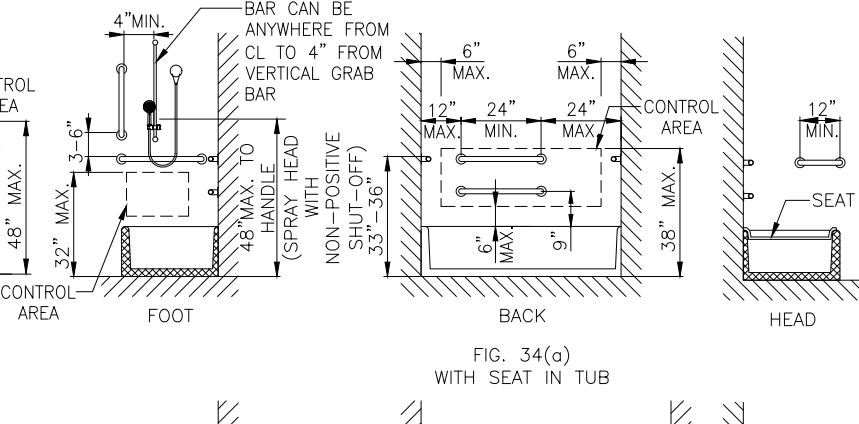

**GRAB BARS AT BATHTUBS**

NOTE: CONTRACTOR TO PROVIDE WOOD BLOCKING IN WALLS FOR GRAB BARS.

REVISIONS	BY

**ECM Consultants, Inc.**  
 ARCHITECTS - ARCHITECTS - CONSTRUCTION MANAGERS  
 1301 CLEARVIEW PKWY. SUITE 200  
 METAIRIE, LOUISIANA 70001  
 PHONE: (504) 885-4080. FAX: (504) 885-1439  
 EMAIL: mail@ecmconsultants.com

**HOUSING AUTHORITY OF NEW ORLEANS**  
 OWNER:  
 PROJECT: GUSTE III COMMUNITY INTERIOR & EXTERIOR REPAIRS  
 SHEET TITLE: TOILET ROOM DETAILS  
 2051 SENATE ST. BUILDING B. RM. 202  
 NEW ORLEANS, LOUISIANA 70122

OWNER:  
 PROJECT: GUSTE III COMMUNITY INTERIOR & EXTERIOR REPAIRS  
 SHEET TITLE: TOILET ROOM DETAILS

DRAWN	M.L.M. & A.E.D.
CHECKED	N.G.W.
DATE	JUN. 21, 2024
SCALE	AS SHOWN
JOB NO.	22462.14
SHEET NO.	

A-100.1

**SCOPE OF WORK NOTES:**

1. THE SCOPE OF WORK SHEET INDICATES WORK THAT IS TO BE PERFORMED IN THE COMMON AREAS OF THE 'M' BLDG. ALL FLOORS. REFER TO PRODUCT DATA NOTES AND DETAILS WHERE APPROPRIATE.

Scope of Work for		Guste III Housing Development			
"M" Building / Work Type		Interior - Common Area - All Floors			
#	Work Item Description	Unit	Quantity	Reference Notes	Rpt #
COM 01	Remove Threshold. Provide new Half Saddle w/ 282 Elevator per detail at both entry doors.	Ea	2	Refer to Product Data Notes and Detail	# 15
COM 02	Existing mailbox to remain. Provide new mailbox in new furr-out per Product Data.	LS	1	Refer to Detail #1 on sheet A-107.1.	# 23
COM 03	Contractor to adjust existing closure force per code requirements. If not, replace with new threshold.	Ea	7	Refer to Rpt#17&18 for location of doors. Refer to Product Data Note #1 for type of closure.	#17 / 18
COM 04	Remove Toilet @ 4th floor. Remove flooring to move toilet per offset flange to be 18" from c/l of toilet. Patch ceramic floor tile as required.	Ea	1	First Toilet Room at 14-1/2" to side wall.	# 20
COM 05	Remove to relocate Grab Bars at rear and side wall in 4th Floor Toilet. Patch and paint entire walls.	LS	2	Refer to Sheet G-003 for code requirements.	# 21
COM 06	Relocate Toilet Tissue Dispenser in 4th Floor Toilet per code requirements.	LS	1	Refer to Sheet G-003 for code requirements.	# 20
COM 07	Provide ADA/Ansi compliant signage at the 4th floor toilet in the Community Room to indicate Unisex toilets. (Mounting Hgt. - 54" to 60" AFF)	Ea	2	Refer to Product Data Note #5 for type of signage and requirements.	# 20

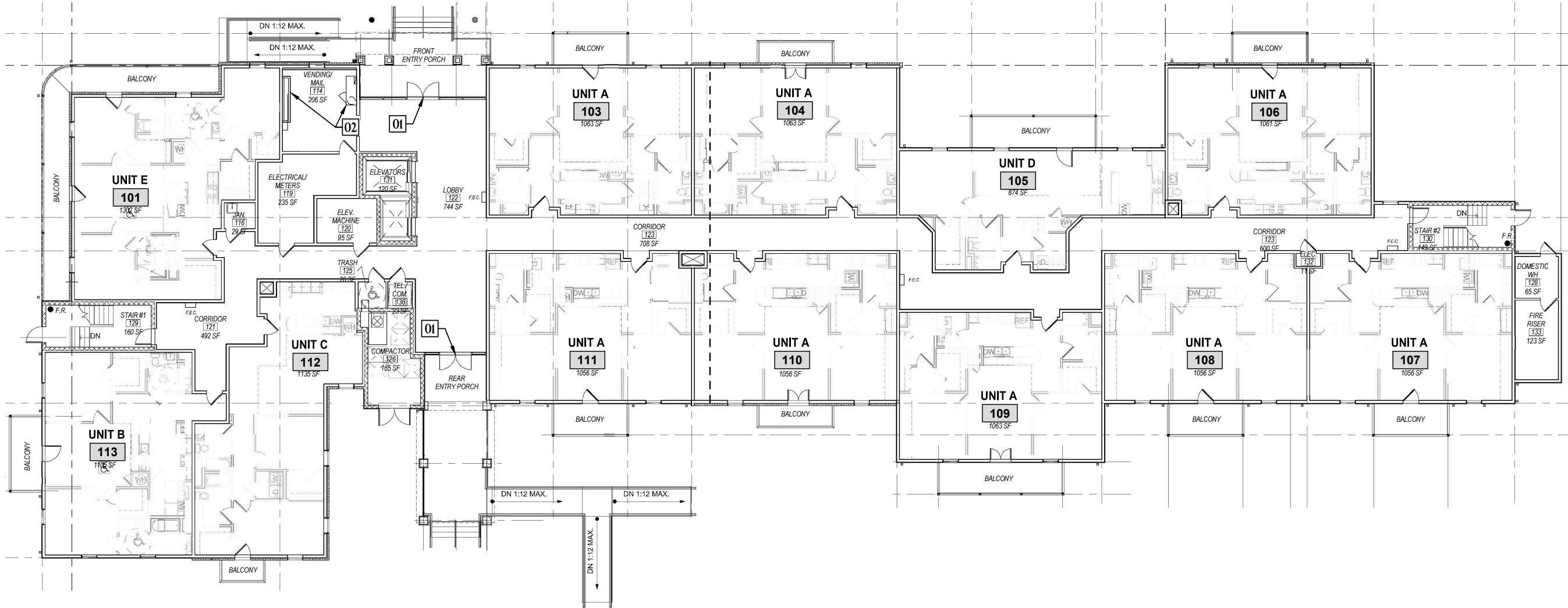

1  
A-101

**FIRST FLOOR OVERALL PLAN**  
GUSTE III - "M" BUILDING

SCALE: 3/32" = 1'-0"



REVISIONS	BY

**ECM Consultants, Inc.**  
 ARCHITECT/ENGINEER:  
 ENGINEERS - ARCHITECTS - CONSTRUCTION MANAGERS  
 1301 CLEARVIEW PKWY. SUITE 200  
 METAIRIE, LOUISIANA 70001  
 PHONE: (504) 885-4080. FAX: (504) 885-1439  
 EMAIL: mail@ecmconsultants.com

OWNER:  
**HOUSING AUTHORITY OF NEW ORLEANS**  
 2051 SENATE ST. BUILDING B, RM. 202  
 NEW ORLEANS, LOUISIANA 70122

PROJECT:  
**GUSTE III COMMUNITY INTERIOR & EXTERIOR REPAIRS**  
 SHEET TITLE:  
**1ST FLOOR OVERALL PLAN**

DRAWN	M.L.M. & A.E.D.
CHECKED	N.G.W.
DATE	JUN. 21, 2024
SCALE	AS SHOWN
JOB NO.	22462.14
SHEET NO.	

A-101

**SCOPE OF WORK NOTES:**

1. THE SCOPE OF WORK SHEET INDICATES WORK THAT IS TO BE PERFORMED IN THE COMMON AREAS OF THE 'M' BLDG. ALL FLOORS. REFER TO PRODUCT DATA NOTES AND DETAILS WHERE APPROPRIATE.

Scope of Work for		Guste III Housing Development			
"M" Building / Work Type		Interior - Common Area - All Floors			
#	Work Item Description	Unit	Quantity	Reference Notes	Rpt #
COM 01	Remove Threshold. Provide new Half Saddle w/ 282 Elevator per detail at both entry doors.	Ea	2	Refer to Product Data Notes and Detail	# 15
COM 02	Existing mailbox to remain. Provide new mailbox in new furr-out per Product Data.	LS	1	Refer to Detail #1 on sheet A-107.1.	# 23
COM 03	Contractor to adjust existing closure force per code requirements. If not, replace with new threshold.	Ea	7	Refer to Rpt#17&18 for location of doors. Refer to Product Data Note #1 for type of closure.	#17 / 18
COM 04	Remove Toilet @ 4th floor. Remove flooring to move toilet per offset flange to be 18" from c/l of toilet. Patch ceramic floor tile as required.	Ea	1	First Toilet Room at 14-1/2" to side wall.	# 20
COM 05	Remove to relocate Grab Bars at rear and side wall in 4th Floor Toilet. Patch and paint entire walls.	LS	2	Refer to Sheet G-003 for code requirements.	# 21
COM 06	Relocate Toilet Tissue Dispenser in 4th Floor Toilet per code requirements.	LS	1	Refer to Sheet G-003 for code requirements.	# 20
COM 07	Provide ADA/Ansi compliant signage at the 4th floor toilet in the Community Room to indicate Unisex toilets. (Mounting Hgt. - 54" to 60" AFF)	Ea	2	Refer to Product Data Note #5 for type of signage and requirements.	# 20

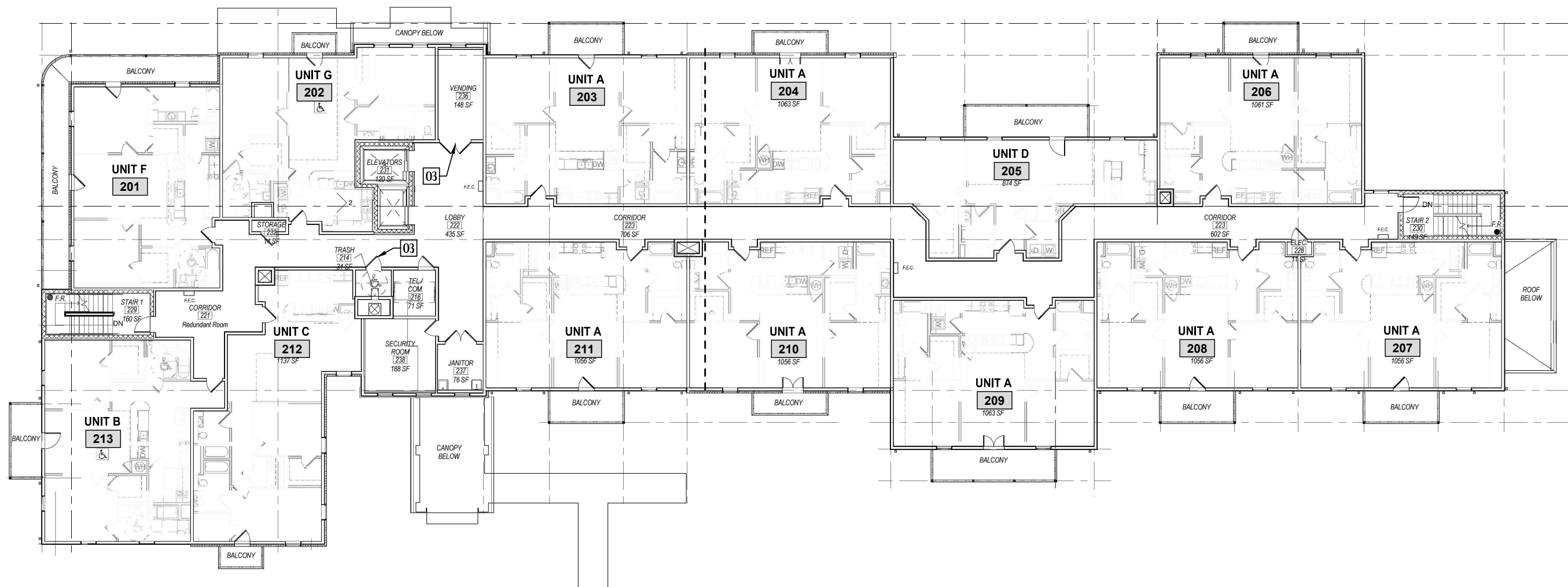

1  
A-102

**SECOND FLOOR OVERALL PLAN**  
GUSTE III - "M" BUILDING

SCALE: 3/32" = 1'-0"



REVISIONS	BY

**ECM Consultants, Inc.**  
ARCHITECT/ENGINEER:  
ENGINEERS - ARCHITECTS - CONSTRUCTION MANAGERS  
1301 CLEARVIEW PKWY. SUITE 200  
METAIRIE, LOUISIANA 70001  
PHONE: (504) 885-4080. FAX: (504) 885-1439  
EMAIL: mail@ecmconsultants.com

OWNER:  
**HOUSING AUTHORITY OF NEW ORLEANS**  
2051 SENATE ST. BUILDING B. RM. 202  
NEW ORLEANS, LOUISIANA 70122

PROJECT:  
**GUSTE III COMMUNITY INTERIOR & EXTERIOR REPAIRS**  
SHEET TITLE:  
**2ND FLOOR OVERALL PLAN**

DRAWN
M.L.M. & A.E.D.
CHECKED
N.G.W.
DATE
JUN. 21, 2024
SCALE
AS SHOWN
JOB NO.
22462.14
SHEET NO.

A-102

**SCOPE OF WORK NOTES:**

1. THE SCOPE OF WORK SHEET INDICATES WORK THAT IS TO BE PERFORMED IN THE COMMON AREAS OF THE 'M' BLDG. ALL FLOORS. REFER TO PRODUCT DATA NOTES AND DETAILS WHERE APPROPRIATE.

Scope of Work for		Guste III Housing Development			
"M" Building / Work Type		Interior - Common Area - All Floors			
#	Work Item Description	Unit	Quantity	Reference Notes	Rpt #
COM 01	Remove Threshold. Provide new Half Saddle w/ 282 Elevator per detail at both entry doors.	Ea	2	Refer to Product Data Notes and Detail	# 15
COM 02	Existing mailbox to remain. Provide new mailbox in new furr-out per Product Data.	LS	1	Refer to Detail #1 on sheet A-107.1.	# 23
COM 03	Contractor to adjust existing closure force per code requirements. If not, replace with new threshold.	Ea	7	Refer to Rpt#17&18 for location of doors. Refer to Product Data Note #1 for type of closure.	#17 / 18
COM 04	Remove Toilet @ 4th floor. Remove flooring to move toilet per offset flange to be 18" from c/l of toilet. Patch ceramic floor tile as required.	Ea	1	First Toilet Room at 14-1/2" to side wall.	# 20
COM 05	Remove to relocate Grab Bars at rear and side wall in 4th Floor Toilet. Patch and paint entire walls.	LS	2	Refer to Sheet G-003 for code requirements.	# 21
COM 06	Relocate Toilet Tissue Dispenser in 4th Floor Toilet per code requirements.	LS	1	Refer to Sheet G-003 for code requirements.	# 20
COM 07	Provide ADA/Ansi compliant signage at the 4th floor toilet in the Community Room to indicate Unisex toilets. (Mounting Hgt. - 54" to 60" AFF)	Ea	2	Refer to Product Data Note #5 for type of signage and requirements.	# 20

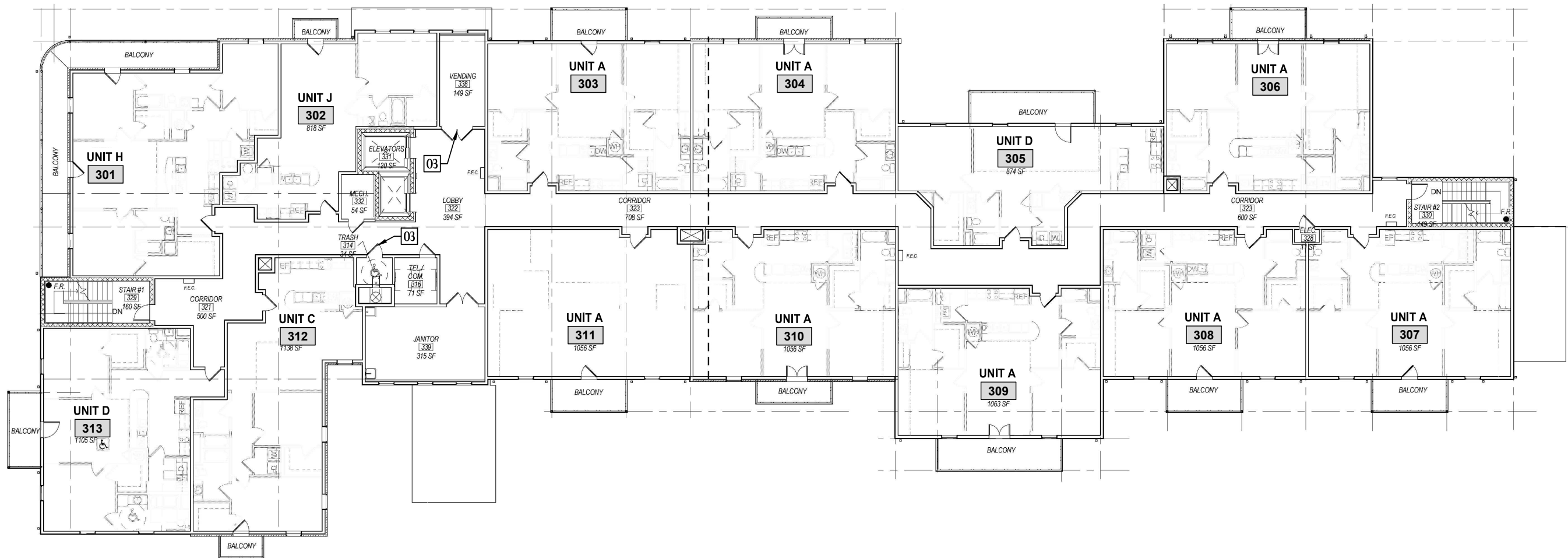

1  
A-103

**THIRD FLOOR OVERALL PLAN**  
GUSTE III - "M" BUILDING

SCALE: 3/32" = 1'-0"



REVISIONS	BY

**ECM Consultants, Inc.**  
ARCHITECT/ENGINEER:  
ENGINEERS - ARCHITECTS - CONSTRUCTION MANAGERS  
1301 CLEARVIEW PKWY. SUITE 200  
METAIRIE, LOUISIANA 70001  
PHONE: (504) 885-4080, FAX: (504) 885-1439  
EMAIL: mail@ecmconsultants.com

OWNER:  
HOUSING AUTHORITY  
OF NEW ORLEANS  
2051 SENATE ST. BUILDING B, RM. 202  
NEW ORLEANS, LOUISIANA 70122

PROJECT:  
GUSTE III COMMUNITY  
INTERIOR & EXTERIOR REPAIRS  
SHEET TITLE:  
3RD FLOOR OVERALL PLAN

DRAWN	M.L.M. & A.E.D.
CHECKED	N.G.W.
DATE	JUN. 21, 2024
SCALE	AS SHOWN
JOB NO.	22462.14
SHEET NO.	

A-103



**SCOPE OF WORK NOTES:**

1. THE SCOPE OF WORK SHEET INDICATES WORK THAT IS TO BE PERFORMED IN THE COMMON AREAS OF THE 'M' BLDG. ALL FLOORS. REFER TO PRODUCT DATA NOTES AND DETAILS WHERE APPROPRIATE.

Scope of Work for		Guste III Housing Development			
"M" Building / Work Type		Interior - Common Area - All Floors			
#	Work Item Description	Unit	Quantity	Reference Notes	Rpt #
COM 01	Remove Threshold. Provide new Half Saddle w/ 282 Elevator per detail at both entry doors.	Ea	2	Refer to Product Data Notes and Detail	# 15
COM 02	Existing mailbox to remain. Provide new mailbox in new furr-out per Product Data.	LS	1	Refer to Detail #1 on sheet A-107.1.	# 23
COM 03	Contractor to adjust existing closure force per code requirements. If not, replace with new threshold.	Ea	7	Refer to Rpt#17&18 for location of doors. Refer to Product Data Note #1 for type of closure.	#17 / 18
COM 04	Remove Toilet @ 4th floor. Remove flooring to move toilet per offset flange to be 18" from c/l of toilet. Patch ceramic floor tile as required.	Ea	1	First Toilet Room at 14-1/2" to side wall.	# 20
COM 05	Remove to relocate Grab Bars at rear and side wall in 4th Floor Toilet. Patch and paint entire walls.	LS	2	Refer to Sheet G-003 for code requirements.	# 21
COM 06	Relocate Toilet Tissue Dispenser in 4th Floor Toilet per code requirements.	LS	1	Refer to Sheet G-003 for code requirements.	# 20
COM 07	Provide ADA/Ansi compliant signage at the 4th floor toilet in the Community Room to indicate Unisex toilets. (Mounting Hgt. - 54" to 60" AFF)	Ea	2	Refer to Product Data Note #5 for type of signage and requirements.	# 20

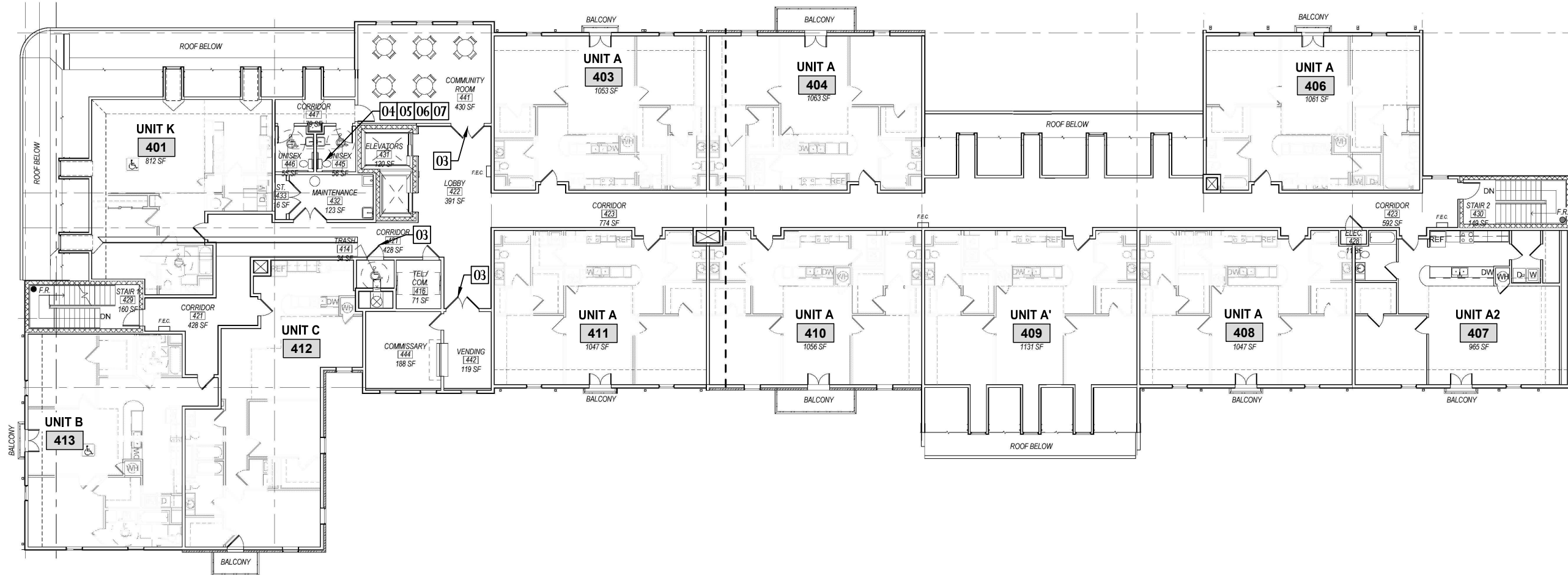

1 FOURTH FLOOR OVERALL PLAN  
A-104 GUSTE III - "M" BUILDING

SCALE: 3/32"= 1'-0"

OVERALL PLAN NORTH

REVISIONS	BY

**ECM Consultants, Inc.**  
 ARCHITECT/ENGINEER:  
 ENGINEERS - ARCHITECTS - CONSTRUCTION MANAGERS  
 1301 CLEARVIEW PKWY. SUITE 200  
 METAIRIE, LOUISIANA 70001  
 PHONE: (504) 885-4080. FAX: (504) 885-1439  
 EMAIL: mail@ecmconsultants.com

OWNER:  
 HOUSING AUTHORITY  
 OF NEW ORLEANS  
 2051 SENATE ST. BUILDING B, RM. 202  
 NEW ORLEANS, LOUISIANA 70122

PROJECT:  
 GUSTE III COMMUNITY  
 INTERIOR & EXTERIOR REPAIRS  
 SHEET TITLE:  
 4TH FLOOR OVERALL PLAN

DRAWN	M.L.M. & A.E.D.
CHECKED	N.G.W.
DATE	JUN. 21, 2024
SCALE	AS SHOWN
JOB NO.	22462.14
SHEET NO.	

A-104



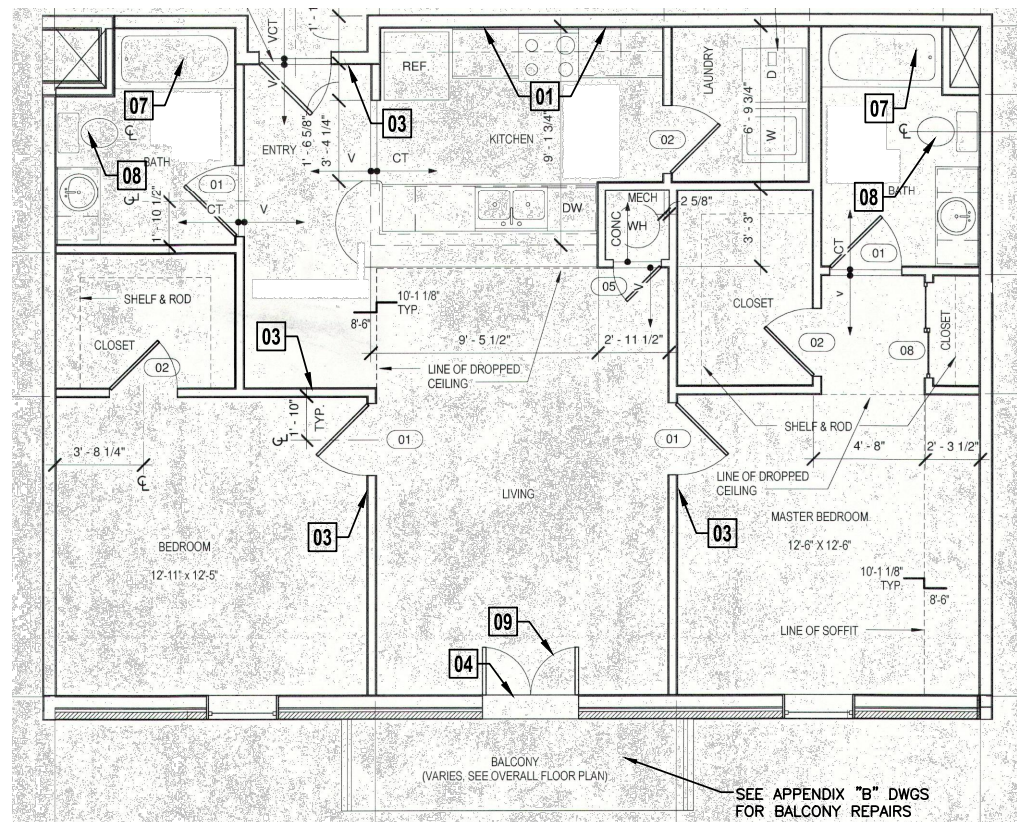

**1**  
A-111 **TYPE A - 2 BDRM**  
TYPICAL UNIT TYPE SCALE: N.T.S.

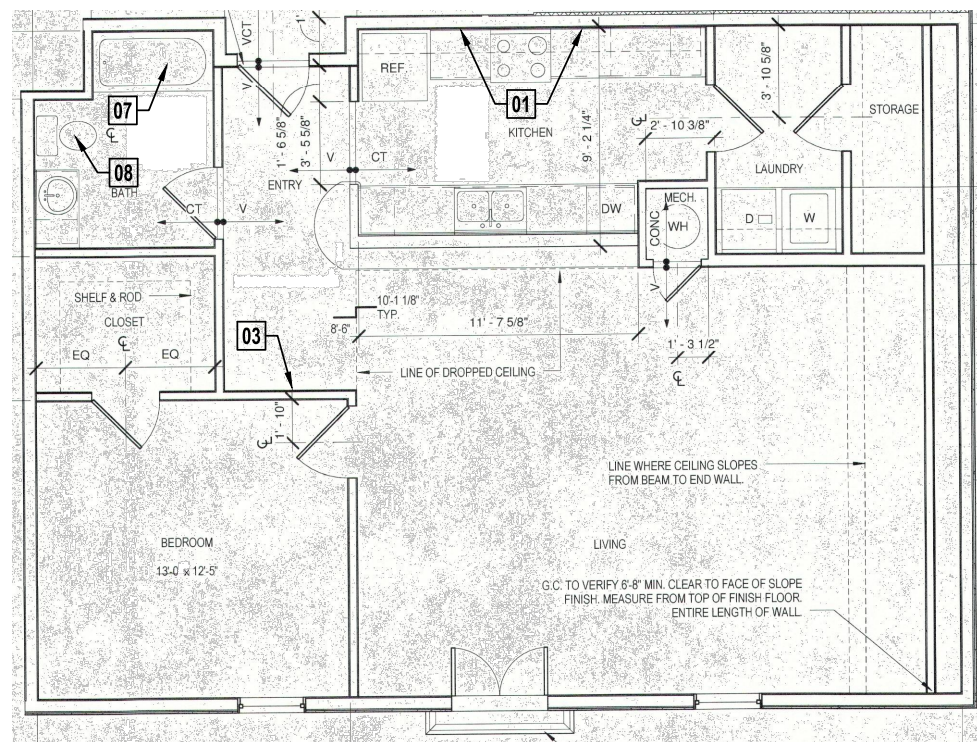

**2**  
A-111 **TYPE A2 - 1 BDRM (407)**  
TYPICAL UNIT TYPE SCALE: N.T.S.

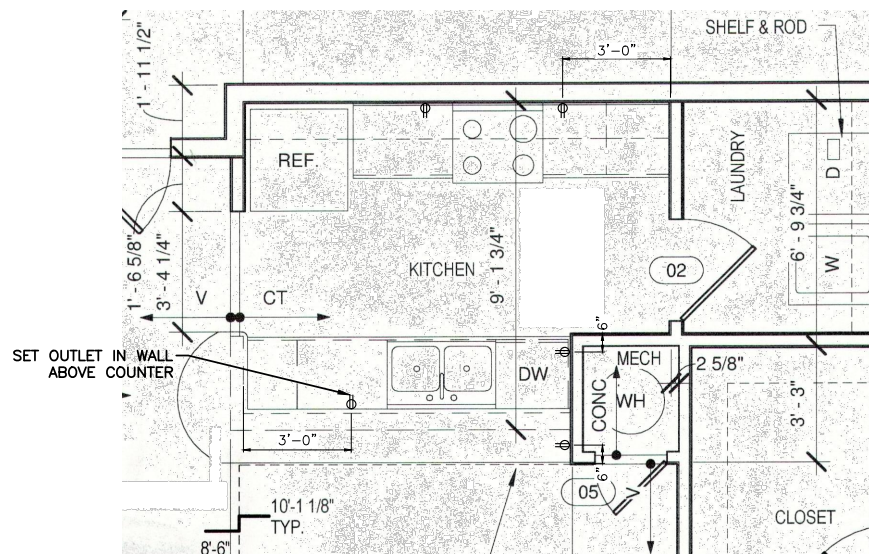

**TYPE A/A2/B - KITCHEN OUTLET LAYOUTS**  
SCALE: 3/8" = 1'-0"

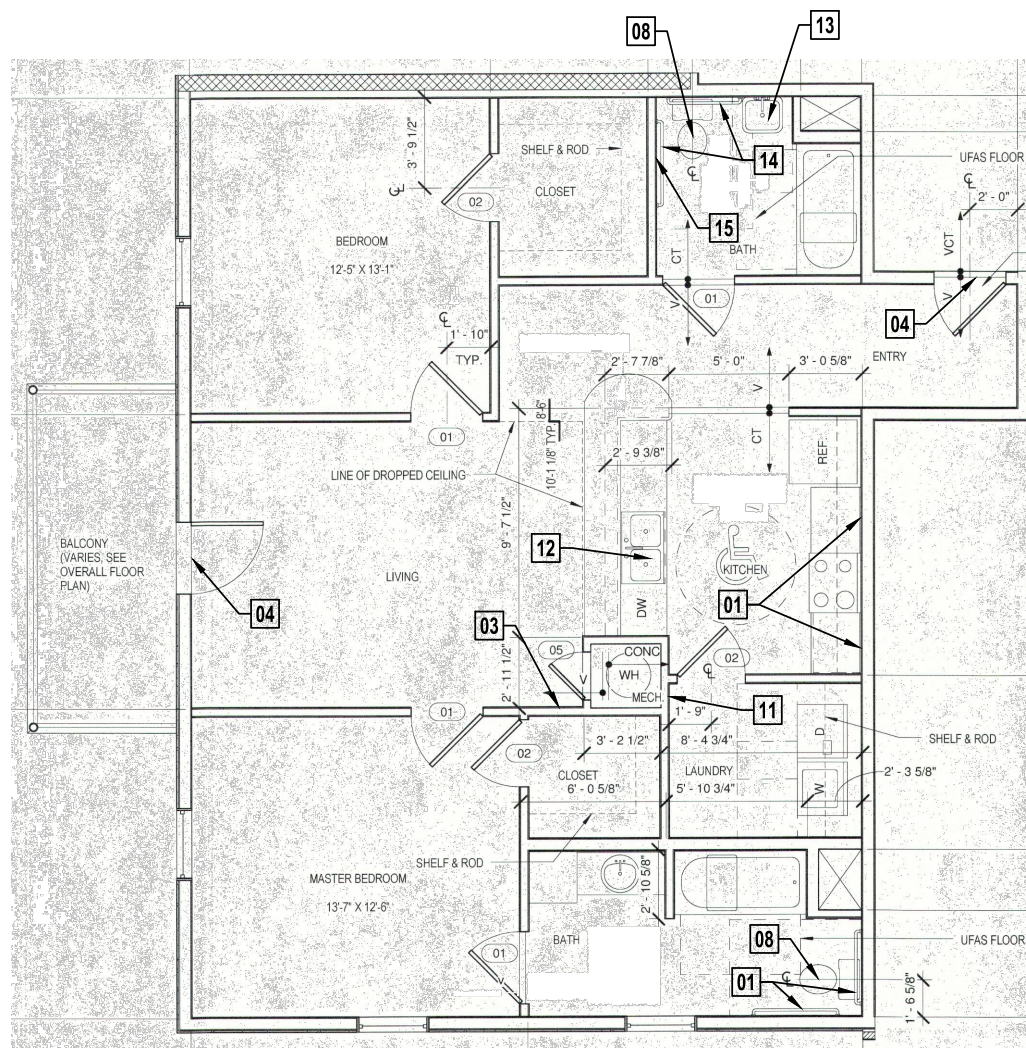

**3**  
A-111 **TYPE B - 2 BDRM-HDCP**  
TYPICAL UNIT TYPE SCALE: N.T.S.

- NOTES:**
- REFER TO SHEETS A-120 THRU A-130 FOR SCOPE OF WORK SHEETS DESCRIBING WORK TO BE PERFORMED IN THE M BUILDING "A" UNITS.
  - REFER TO SHEETS A-126 FOR SCOPE OF WORK SHEETS DESCRIBING WORK TO BE PERFORMED IN THE M BUILDING "A2" UNITS.
  - REFER TO SHEETS A-121, A-123, A-125, & A-127 FOR SCOPE OF WORK SHEETS DESCRIBING WORK TO BE PERFORMED IN THE M BUILDING "B" UNITS.
  - REFER TO DETAILS ON SHEETS A-141 AND A-142 FOR ADDITIONAL INFORMATION.
  - ABOVE COUNTER OUTLETS SHALL BE MOUNTED PER CODE REQUIREMENTS.
  - OUTLETS AND SWITCHES ABOVE COUNTERS TO BE 46" A.F.F. MAX. REACH TO OUTLETS TO BE 24" AT HDCP UNITS AND 25-1/2" IN NON-HDCP UNITS.

REVISIONS	BY

**ARCHITECT/ENGINEER:**  
**ECM Consultants, Inc.**  
ENGINEERS - ARCHITECTS - CONSTRUCTION MANAGERS  
1301 CLEARVIEW PKWY, SUITE 200  
METAIRIE, LOUISIANA 70001  
PHONE: (504) 885-4080, FAX: (504) 885-1439  
EMAIL: mail@ecmconsultants.com

**OWNER:**  
**HOUSING AUTHORITY OF NEW ORLEANS**  
2051 SENATE ST. BUILDING B, RM. 202  
NEW ORLEANS, LOUISIANA 70122

**PROJECT:**  
**GUSTE III COMMUNITY INTERIOR & EXTERIOR REPAIRS**  
**SHEET TITLE:**  
**TYPICAL UNIT TYPE PLANS**

<b>DRAWN</b> M.L.M. & A.E.D.
<b>CHECKED</b> N.G.W.
<b>DATE</b> JUN. 21, 2024
<b>SCALE</b> AS SHOWN
<b>JOB NO.</b> 22462.14
<b>SHEET NO.</b>

**A-111**



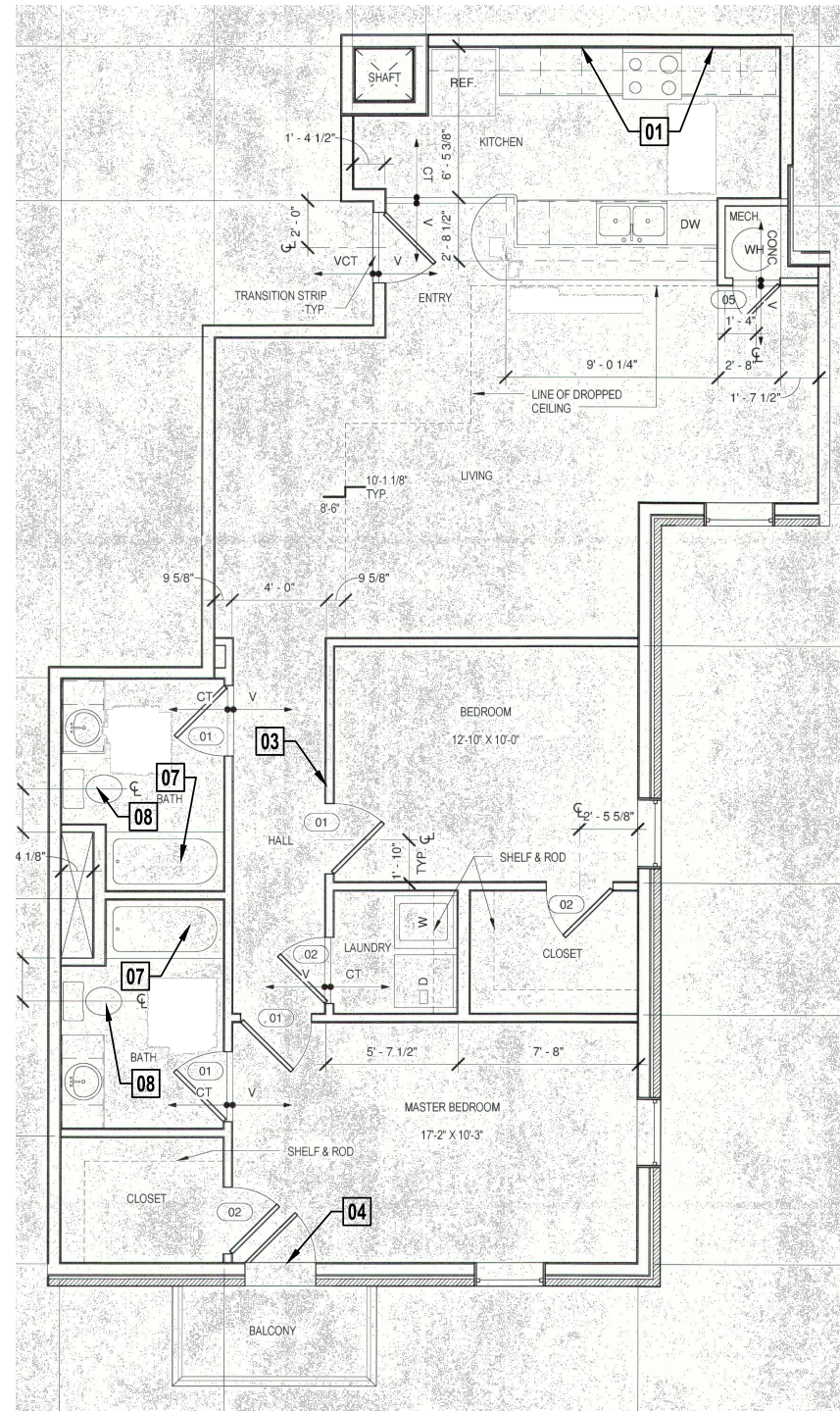

**1** TYPE C - 2 BDRM  
A-112 TYPICAL UNIT TYPE SCALE: N.T.S.

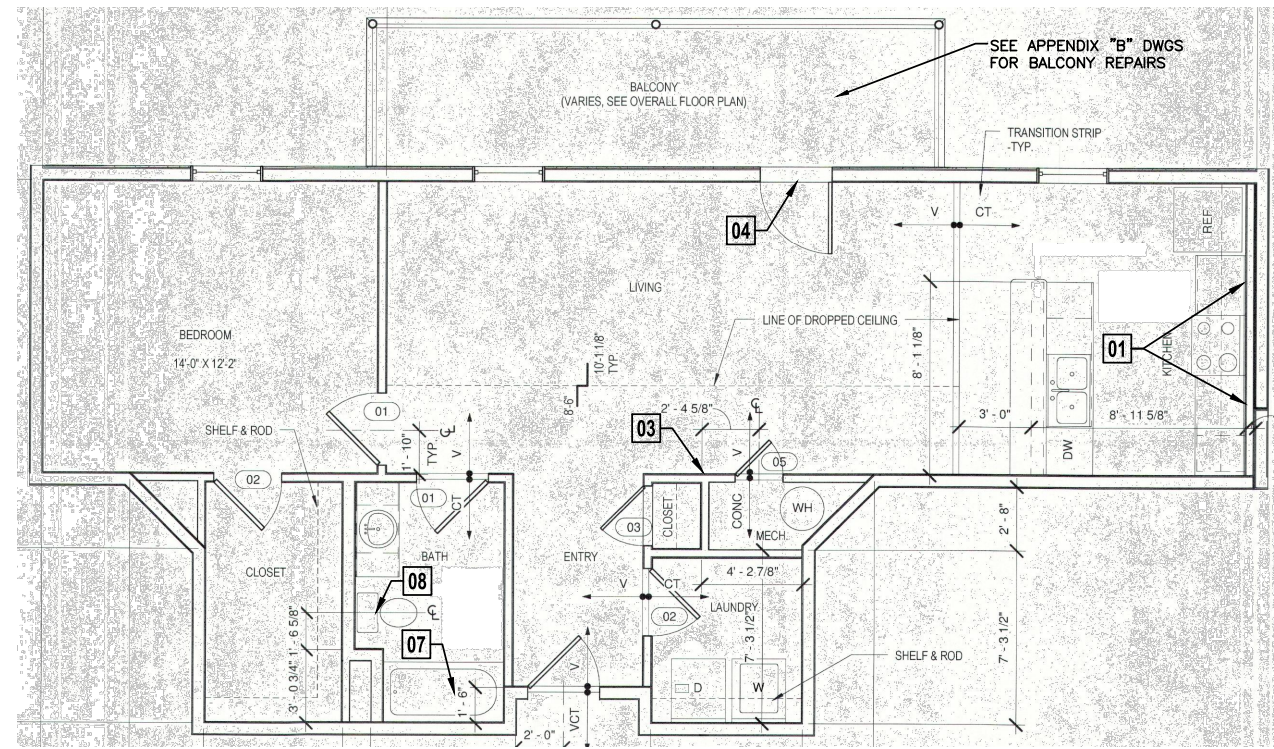

**2** TYPE D - 1 BDRM  
A-112 TYPICAL UNIT TYPE SCALE: N.T.S.

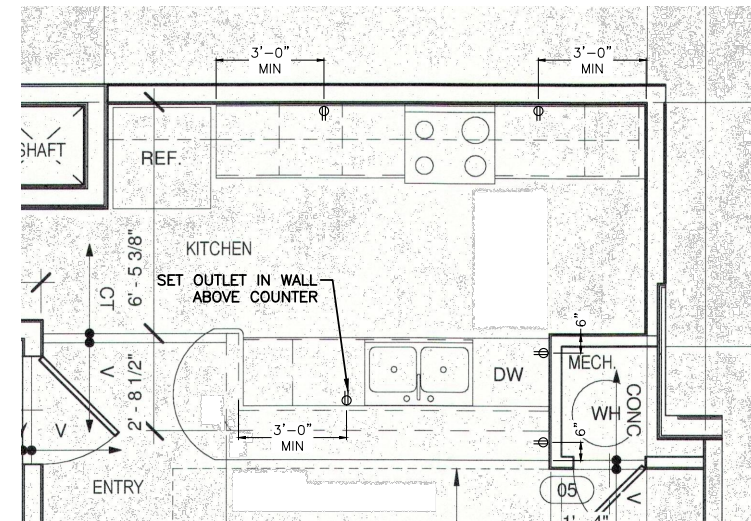

TYPE C - KITCHEN OUTLET LAYOUTS  
SCALE: 3/8" = 1'-0"

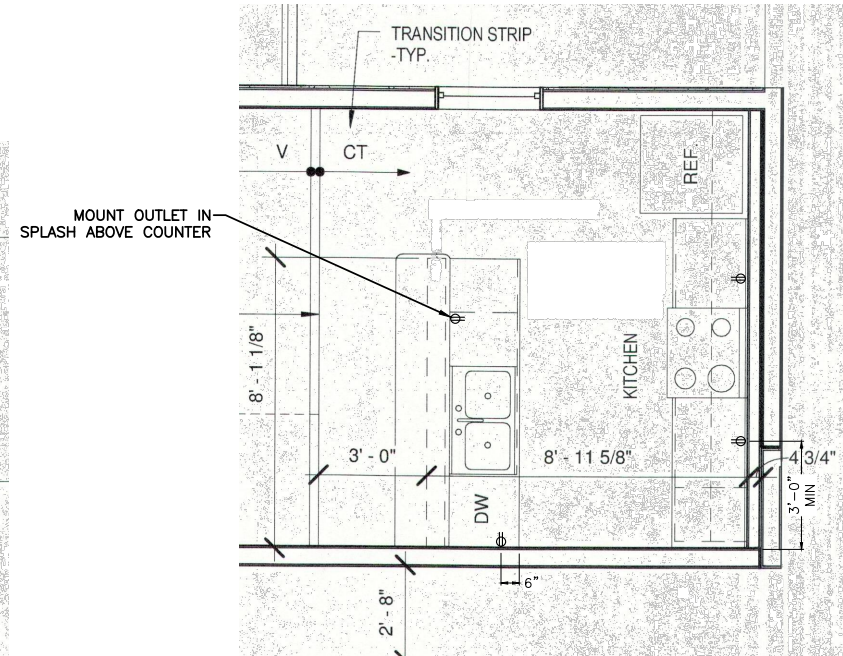

TYPE D - KITCHEN OUTLET LAYOUTS  
SCALE: 3/8" = 1'-0"

- NOTES:**
1. REFER TO SHEETS A-121, A-123, A-125, & A-127 FOR SCOPE OF WORK SHEETS DESCRIBING WORK TO BE PERFORMED IN THE M BUILDING "C" UNITS.
  2. REFER TO SHEETS A-120, A-122, & A-124 FOR SCOPE OF WORK SHEETS DESCRIBING WORK TO BE PERFORMED IN THE M BUILDING "D" UNITS.
  3. REFER TO DETAILS ON SHEETS A-141 AND A-142 FOR ADDITIONAL INFORMATION.
  4. ABOVE COUNTER OUTLETS SHALL BE MOUNTED PER CODE REQUIREMENTS.
  5. OUTLETS AND SWITCHES ABOVE COUNTERS TO BE 46" A.F.F. MAX. REACH TO OUTLETS TO BE 24" AT HDPC UNITS AND 25 1/2" IN NON-HDPC UNITS.

REVISIONS	BY

**ARCHITECT/ENGINEER:**  
**ECM Consultants, Inc.**  
ENGINEERS - ARCHITECTS - CONSTRUCTION MANAGERS  
1301 CLEARVIEW PKWY, SUITE 200  
METAIRIE, LOUISIANA 70001  
PHONE: (504) 885-4080, FAX: (504) 885-1439  
EMAIL: mail@ecmconsultants.com

**OWNER:**  
HOUSING AUTHORITY  
OF NEW ORLEANS  
2051 SENATE ST. BUILDING B, RM. 202  
NEW ORLEANS, LOUISIANA 70122

**PROJECT:**  
GUSTE III COMMUNITY  
INTERIOR & EXTERIOR REPAIRS

**SHEET TITLE:**  
TYPICAL UNIT TYPE PLANS

<b>DRAWN</b> M.L.M. & A.E.D.
<b>CHECKED</b> N.G.W.
<b>DATE</b> JUN. 21, 2024
<b>SCALE</b> AS SHOWN
<b>JOB NO.</b> 22462.14
<b>SHEET NO.</b>

A-112



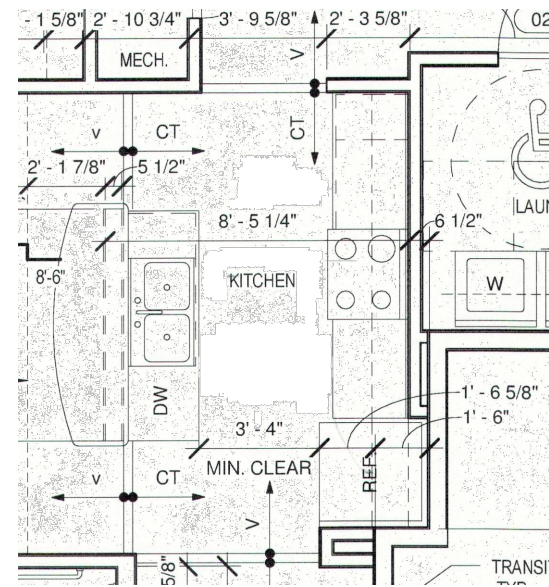

**TYPE E - KITCHEN OUTLET LAYOUTS**

SCALE: 3/8" = 1'-0"

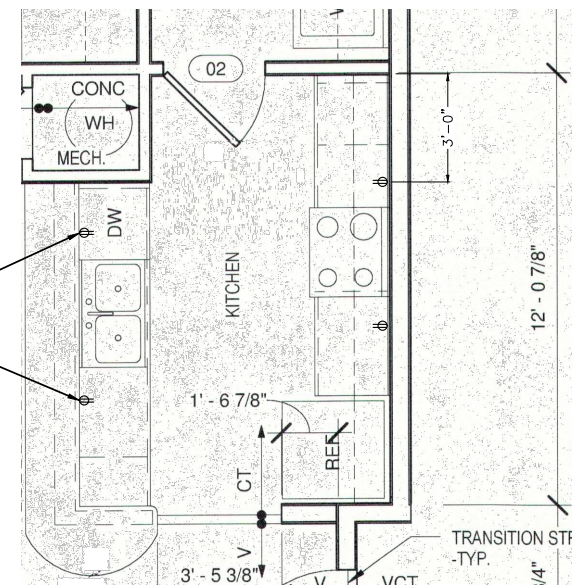

**TYPE F - KITCHEN OUTLET LAYOUTS**

SCALE: 3/8" = 1'-0"

SET OUTLETS IN WALL ABOVE COUNTERS

**NOTES:**

1. REFER TO SHEET A-120 FOR SCOPE OF WORK SHEETS DESCRIBING WORK TO BE PERFORMED IN THE M BUILDING "E" UNITS.
2. REFER TO SHEET A-122 FOR SCOPE OF WORK SHEETS DESCRIBING WORK TO BE PERFORMED IN THE M BUILDING "F" UNITS.
3. REFER TO DETAILS ON SHEETS A-141 AND A-142 FOR ADDITIONAL INFORMATION.
4. ABOVE COUNTER OUTLETS SHALL BE MOUNTED PER CODE REQUIREMENTS.
5. OUTLETS AND SWITCHES ABOVE COUNTERS TO BE 46" A.F.F. MAX. REACH TO OUTLETS TO BE 24" AT HDCP UNITS AND 25-1/2" IN NON-HDCP UNITS.

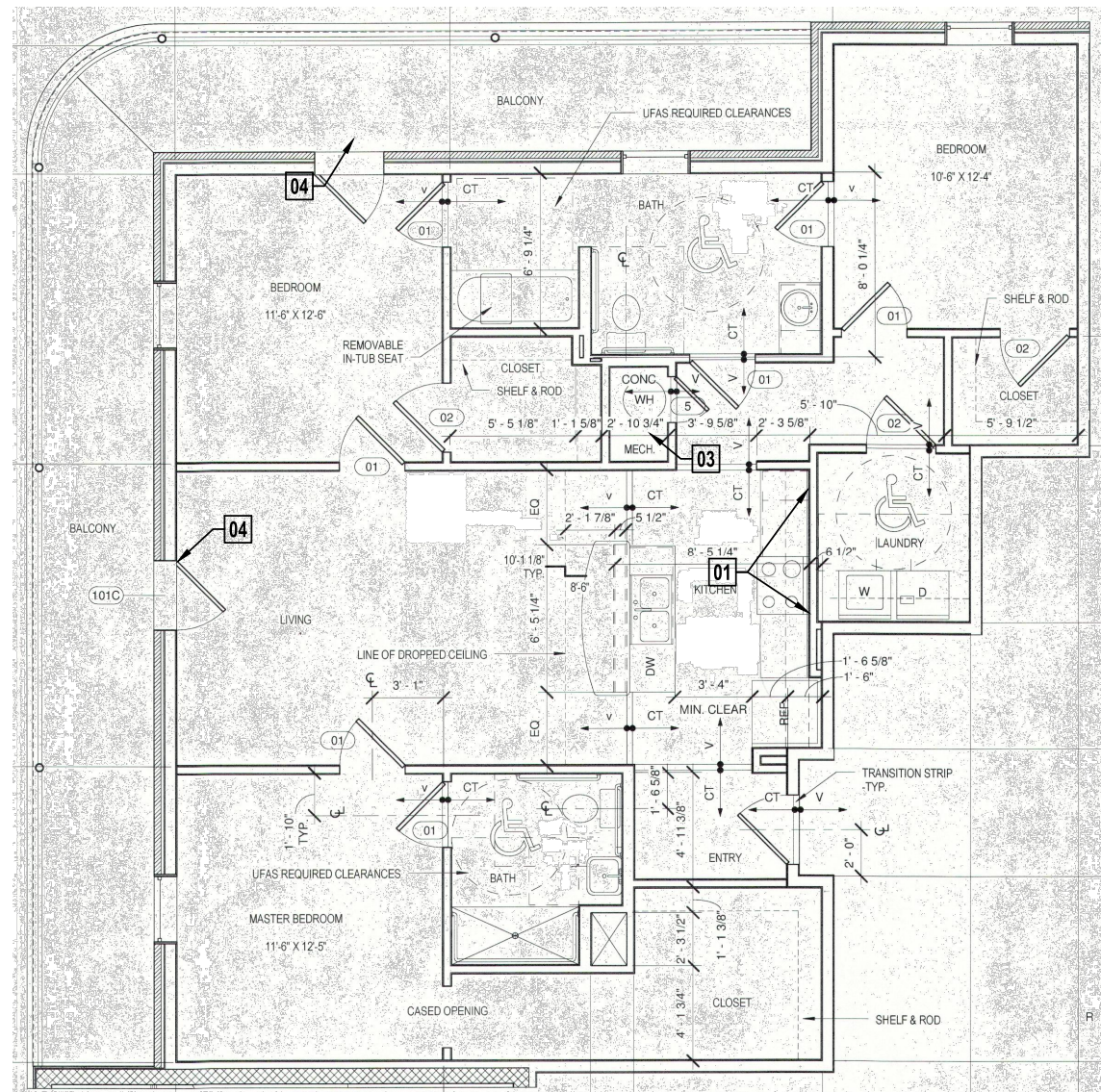

**1 TYPE E - 3 BDRM (101) - HDCP**  
TYPICAL UNIT TYPE SCALE: N.T.S.

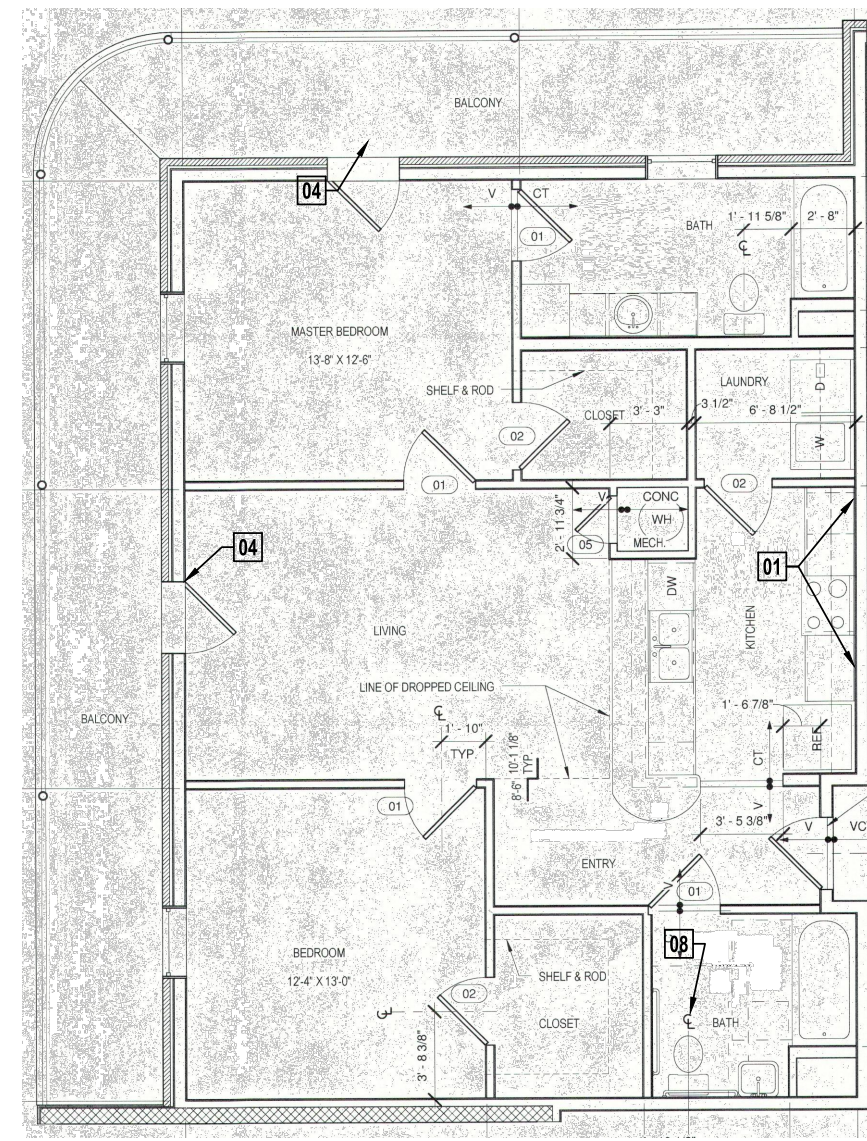

**2 TYPE F - 2 BDRM (201)**  
TYPICAL UNIT TYPE SCALE: N.T.S.

REVISIONS	BY

**ECM Consultants, Inc.**  
ARCHITECT/ENGINEER  
ENGINEERS - ARCHITECTS - CONSTRUCTION MANAGERS  
1301 CLEARVIEW PKWY. SUITE 200  
METAIRIE, LOUISIANA 70001  
PHONE: (504) 885-4080, FAX: (504) 885-1439  
EMAIL: mail@ecmconsultants.com

**HOUSING AUTHORITY OF NEW ORLEANS**  
OWNER:  
2051 SENATE ST. BUILDING B, RM. 202  
NEW ORLEANS, LOUISIANA 70122

**GUSTE III COMMUNITY INTERIOR & EXTERIOR REPAIRS**  
PROJECT:  
SHEET TITLE:  
TYPICAL UNIT TYPE PLANS

DRAWN	M.L.M. & A.E.D.
CHECKED	N.G.W.
DATE	JUN. 21, 2024
SCALE	AS SHOWN
JOB NO.	22462.14
SHEET NO.	

**A-113**



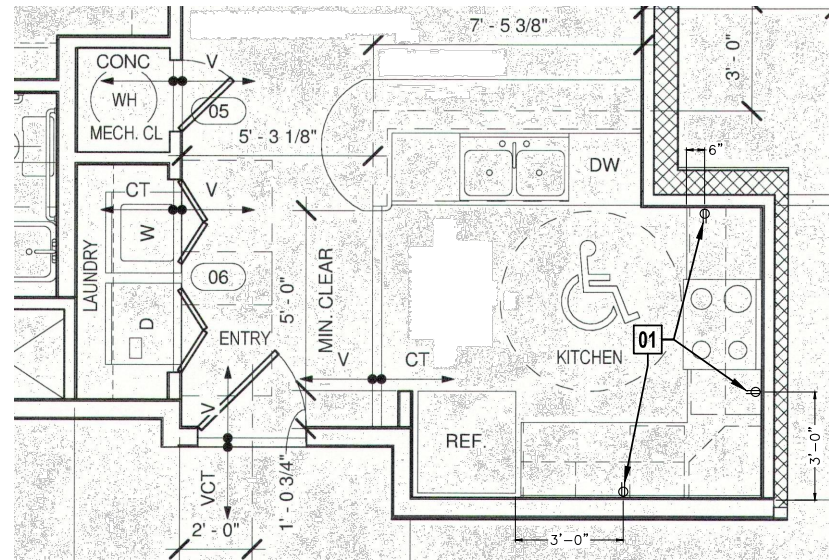

**TYPE G - KITCHEN OUTLET LAYOUTS**

SCALE: 3/8" = 1'-0"

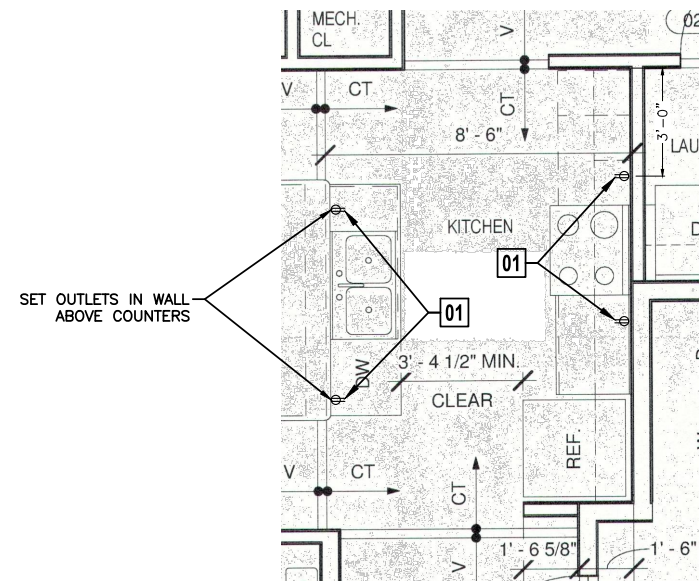

**TYPE H - KITCHEN OUTLET LAYOUTS**

SCALE: 3/8" = 1'-0"

**NOTES:**

1. REFER TO SHEET A-122 FOR SCOPE OF WORK SHEETS DESCRIBING WORK TO BE PERFORMED IN THE M BUILDING "G" UNITS.
2. REFER TO SHEET A-124 FOR SCOPE OF WORK SHEETS DESCRIBING WORK TO BE PERFORMED IN THE M BUILDING "H" UNITS.
3. REFER TO DETAILS ON SHEETS A-141 AND A-142 FOR ADDITIONAL INFORMATION.
4. ABOVE COUNTER OUTLETS SHALL BE MOUNTED PER CODE REQUIREMENTS.
5. OUTLETS AND SWITCHES ABOVE COUNTERS TO BE 46" A.F.F. MAX. REACH TO OUTLETS TO BE 24" AT HDPC UNITS AND 25-1/2" IN NON-HDPC UNITS.

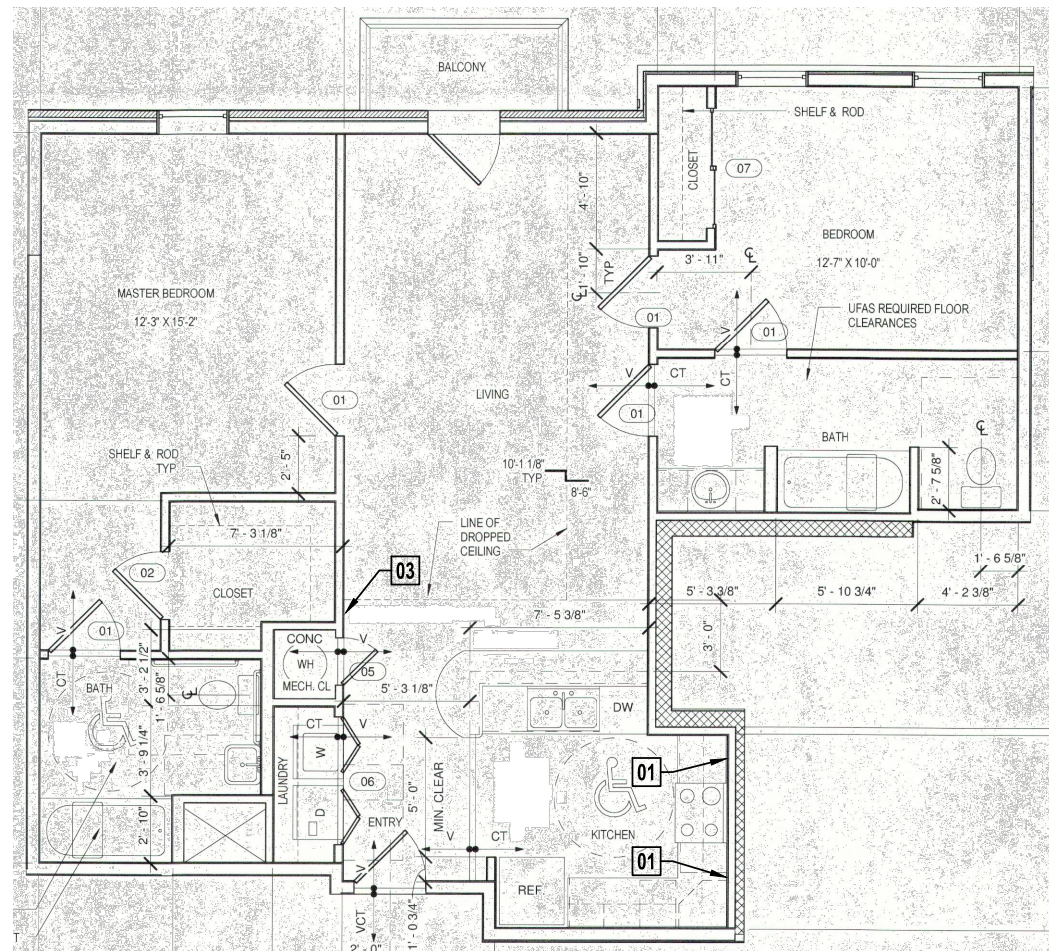

1  
A-114

**TYPE G - 2 BDRM (202) - HDPC**  
TYPICAL UNIT TYPE

SCALE: N.T.S.

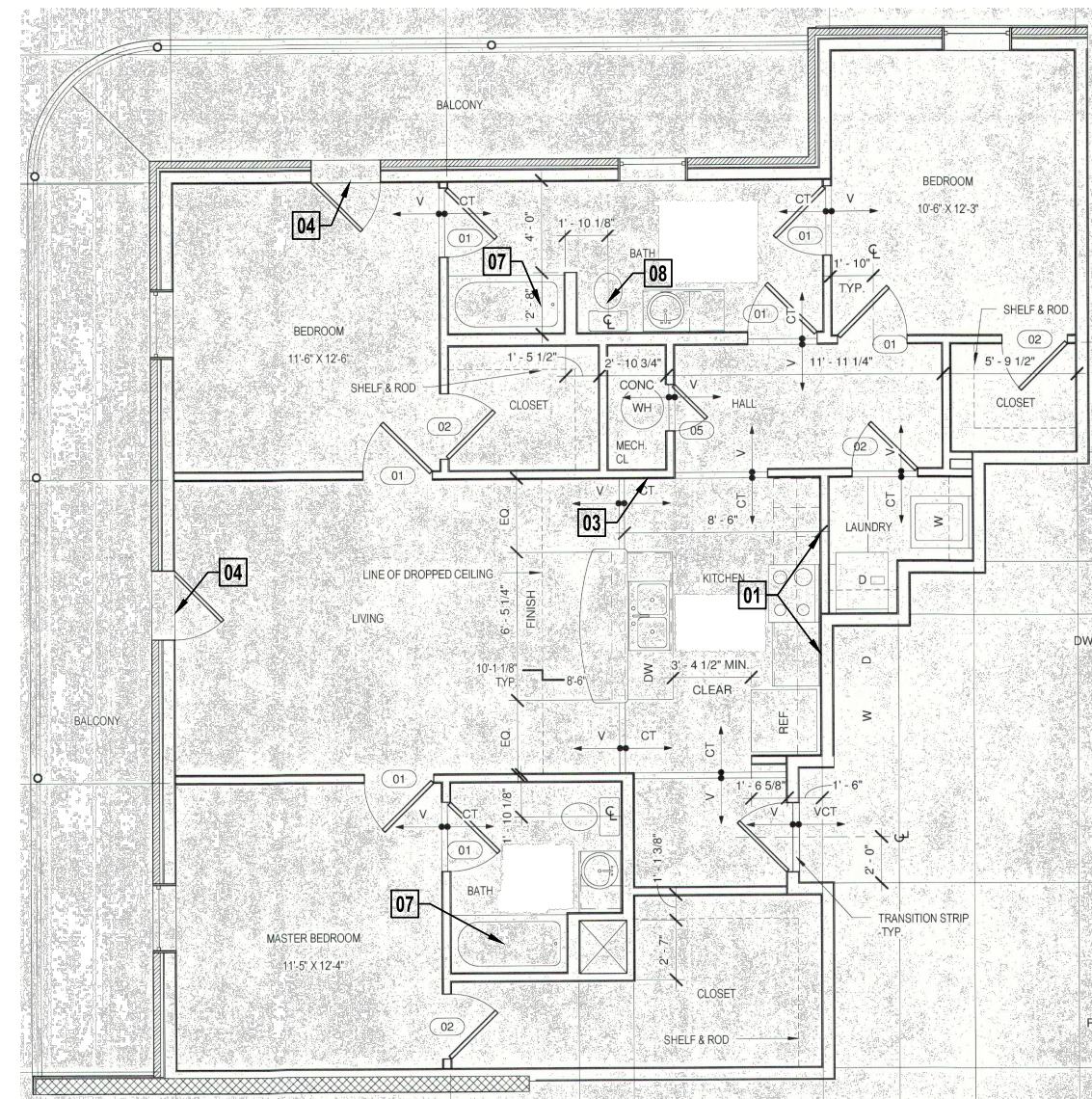

2  
A-114

**TYPE H - 3 BDRM (301)**  
TYPICAL UNIT TYPE

SCALE: N.T.S.

REVISIONS	BY

**ECM Consultants, Inc.**  
ARCHITECT/ENGINEER:  
ENGINEERS - ARCHITECTS - CONSTRUCTION MANAGERS  
1301 CLEARVIEW PKWY, SUITE 200  
METAIRIE, LOUISIANA 70001  
PHONE: (504) 885-4080, FAX: (504) 885-1439  
EMAIL: mail@ecmconsultants.com

OWNER:  
**HOUSING AUTHORITY OF NEW ORLEANS**  
2051 SENATE ST. BUILDING B, RM. 202  
NEW ORLEANS, LOUISIANA 70122

PROJECT:  
**GUSTE III COMMUNITY INTERIOR & EXTERIOR REPAIRS**  
SHEET TITLE:  
**TYPICAL UNIT TYPE PLANS**

DRAWN	M.L.M. & A.E.D.
CHECKED	N.G.W.
DATE	JUN. 21, 2024
SCALE	AS SHOWN
JOB NO.	22462.14
SHEET NO.	

A-114



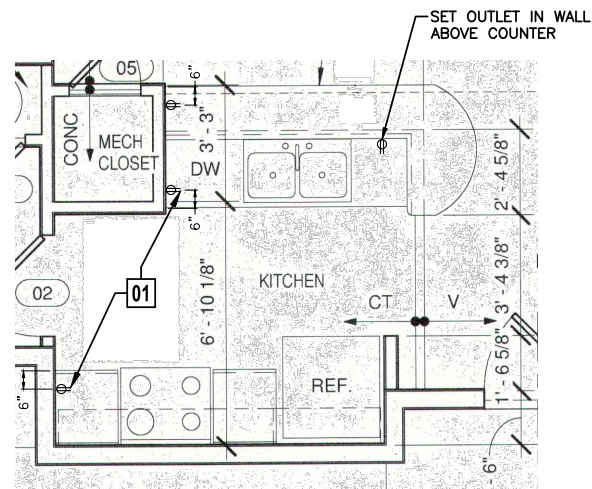

**TYPE J - KITCHEN OUTLET LAYOUTS**

SCALE: 3/8" = 1'-0"

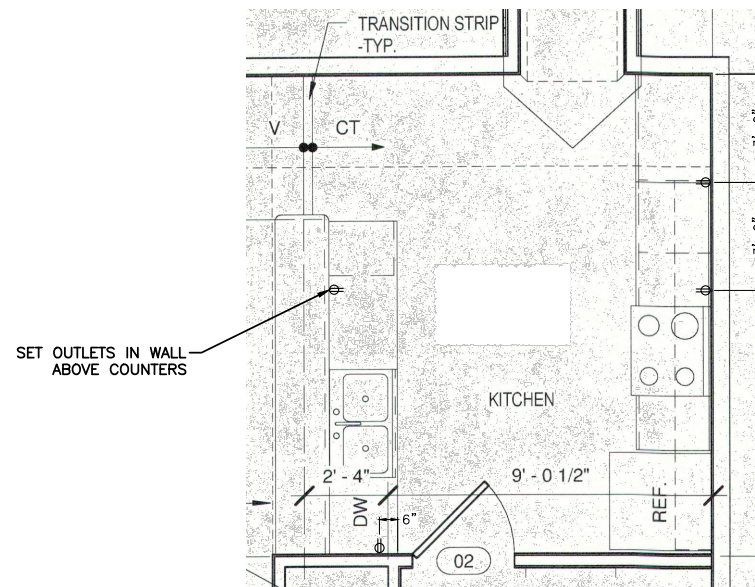

**TYPE K - KITCHEN OUTLET LAYOUTS**

SCALE: 3/8" = 1'-0"

**NOTES:**

1. REFER TO SHEET A-124 FOR SCOPE OF WORK SHEETS DESCRIBING WORK TO BE PERFORMED IN THE M BUILDING "J" UNIT.
2. REFER TO SHEET A-126 FOR SCOPE OF WORK SHEETS DESCRIBING WORK TO BE PERFORMED IN THE M BUILDING "K" UNIT.
3. REFER TO DETAILS ON SHEETS A-141 AND A-142 FOR ADDITIONAL INFORMATION.
4. ABOVE COUNTER OUTLETS SHALL BE MOUNTED PER CODE REQUIREMENTS.
5. OUTLETS AND SWITCHES ABOVE COUNTERS TO BE 46" A.F.F. MAX. REACH TO OUTLETS TO BE 24" AT HDPC UNITS AND 25-1/2" IN NON-HDCP UNITS.

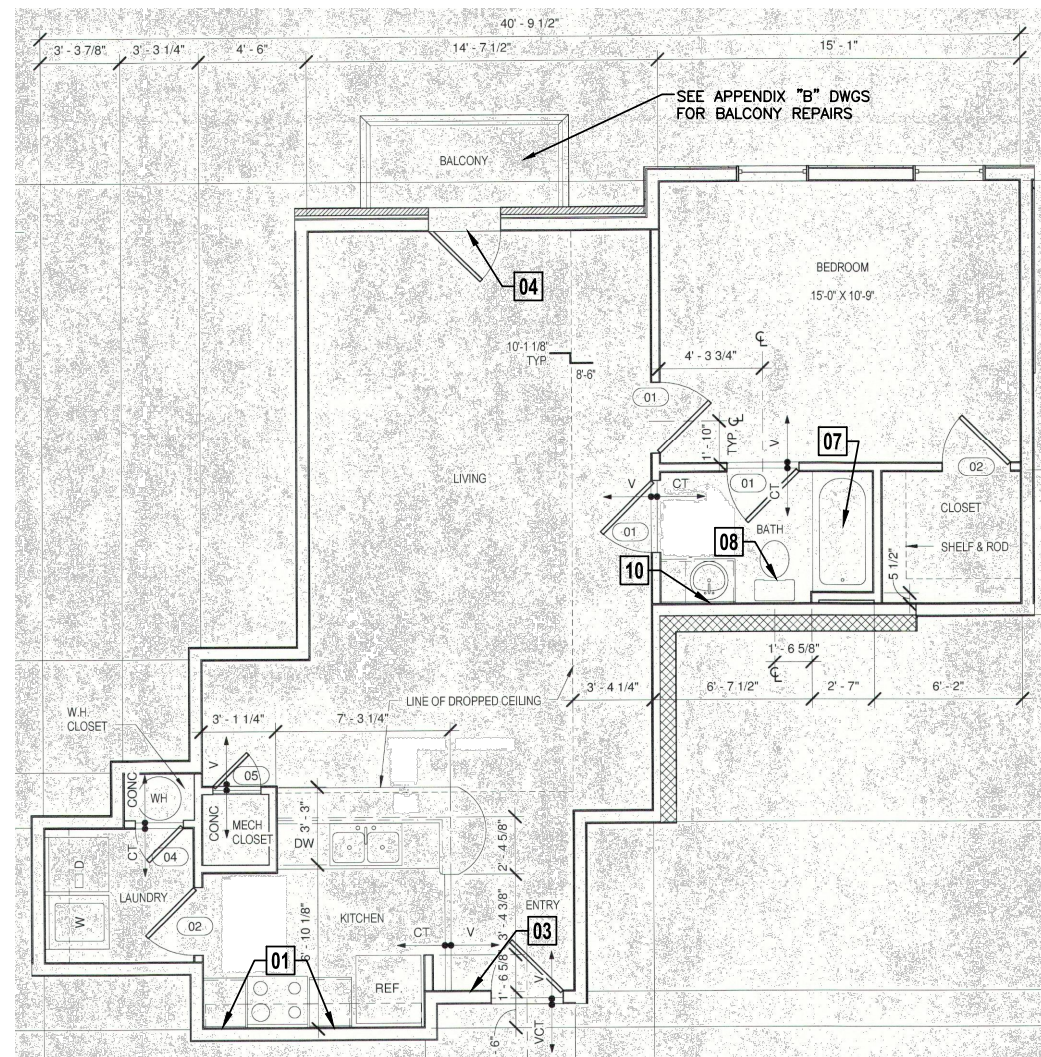

**1 TYPE J - 1 BDRM (302)**  
A-115 TYPICAL UNIT TYPE SCALE: N.T.S.

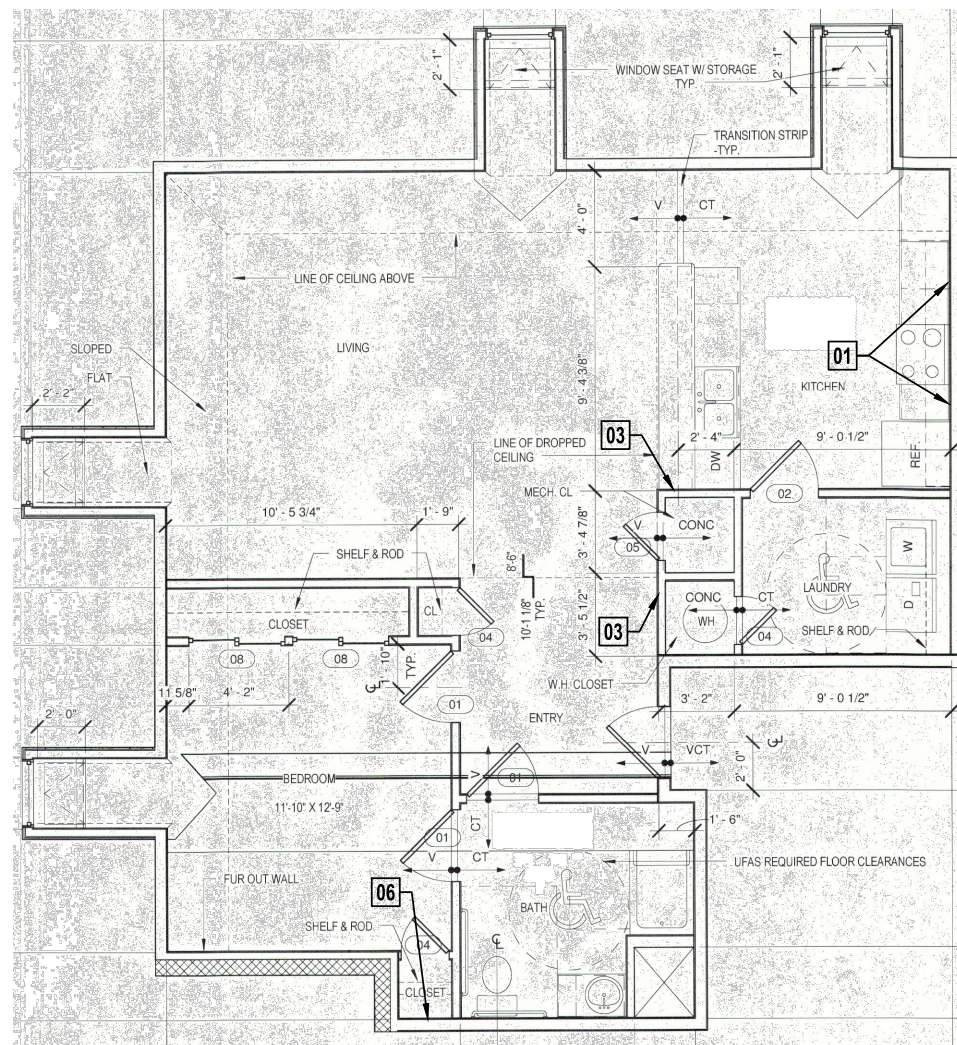

**2 TYPE K - 1 BDRM (401)**  
A-115 TYPICAL UNIT TYPE SCALE: N.T.S.

REVISIONS	BY

**ECM Consultants, Inc.**  
ARCHITECT/ENGINEER  
ENGINEERS - ARCHITECTS - CONSTRUCTION MANAGERS  
1301 CLEARVIEW PKWY. SUITE 200  
METAIRIE, LOUISIANA 70001  
PHONE: (504) 885-4080, FAX: (504) 885-1439  
EMAIL: mail@ecmconsultants.com

OWNER:  
**HOUSING AUTHORITY OF NEW ORLEANS**  
2051 SENATE ST. BUILDING B, RM. 202  
NEW ORLEANS, LOUISIANA 70122

PROJECT:  
**GUSTE III COMMUNITY INTERIOR & EXTERIOR REPAIRS**  
SHEET TITLE:  
**TYPICAL UNIT TYPE PLANS**

DRAWN	M.L.M. & A.E.D.
CHECKED	N.G.W.
DATE	JUN. 21, 2024
SCALE	AS SHOWN
JOB NO.	22462.14
SHEET NO.	

**A-115**



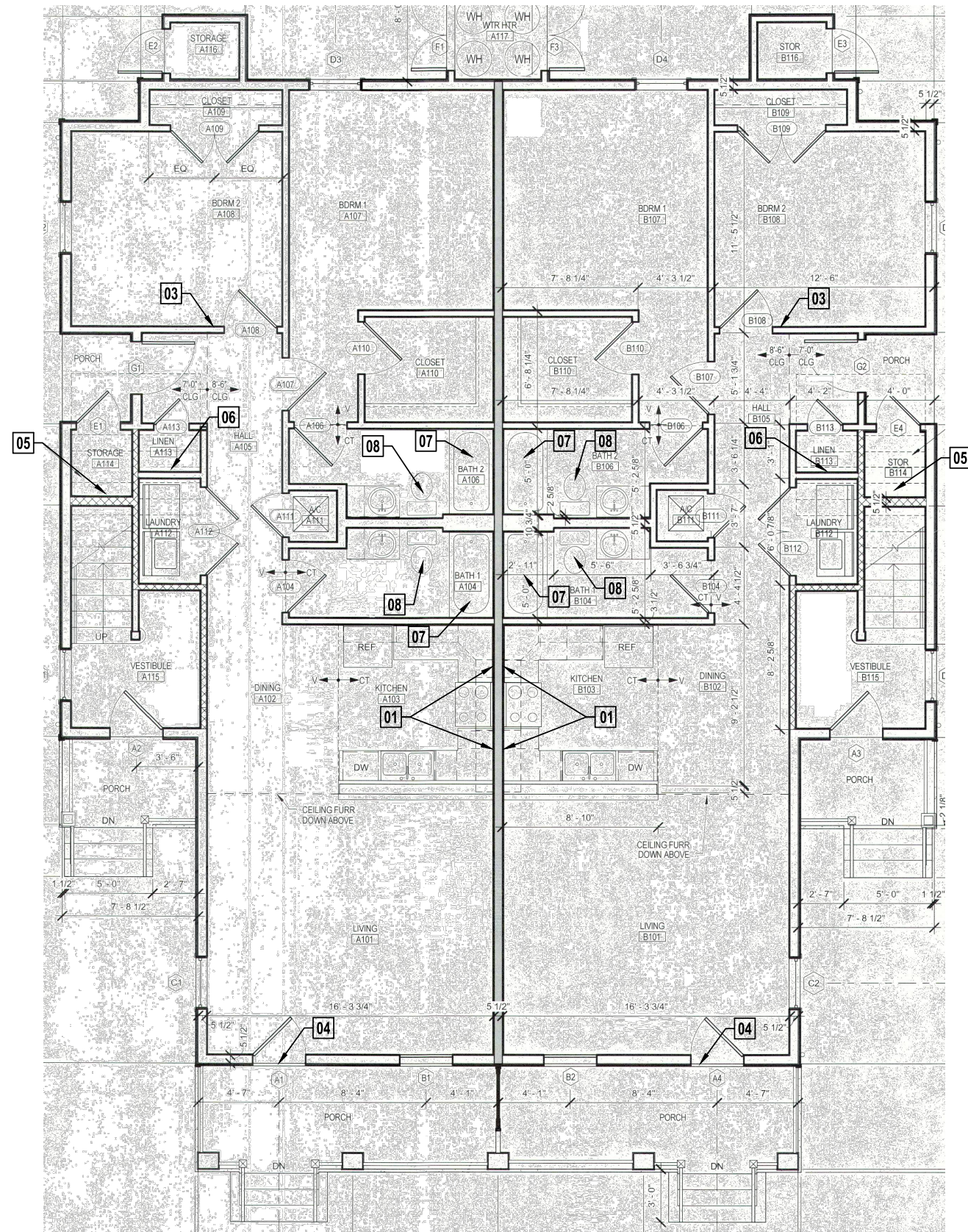

**1** TYPE G - 2 BDRM  
A-116 TYPICAL UNIT TYPE SCALE: N.T.S.

1210 REV JOHN RAPHAEL JR WAY 2306 ERATO STREET  
 1212 REV JOHN RAPHAEL JR WAY 2410 ERATO STREET  
 1217 REV JOHN RAPHAEL JR WAY 2412 ERATO STREET  
 1217 S. LIBERTY STREET

**NOTES:**

1. REFER TO SHEET A-128 FOR SCOPE OF WORK SHEETS DESCRIBING WORK TO BE PERFORMED IN GUSTE III "G" UNITS.
2. REFER TO DETAILS ON SHEETS A-141 AND A-142 FOR ADDITIONAL INFORMATION.
3. ABOVE COUNTER OUTLETS SHALL BE MOUNTED PER CODE REQUIREMENTS.
4. OUTLETS AND SWITCHES ABOVE COUNTERS TO BE 46" A.F.F. MAX. REACH TO OUTLETS TO BE 24" AT HDCC UNITS AND 25-1/2" IN NON-HDCC UNITS.

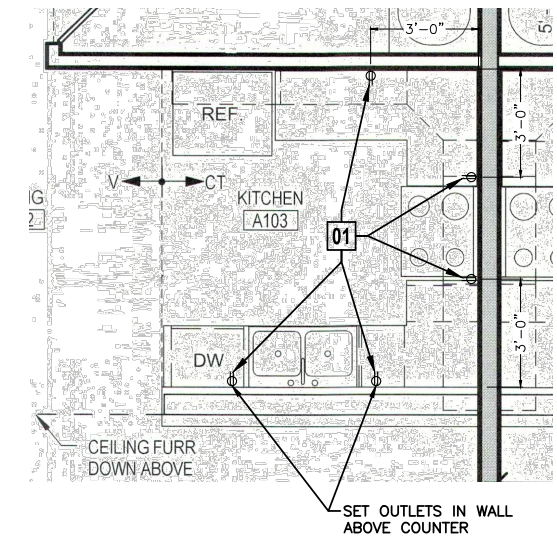

**TYPE G - KITCHEN OUTLET LAYOUTS**  
SCALE: 3/8" = 1'-0"

REVISIONS	BY

**ECM Consultants, Inc.**  
 ARCHITECT/ENGINEER  
 ENGINEERS - ARCHITECTS - CONSTRUCTION MANAGERS  
 1301 CLEARVIEW PKWY. SUITE 200  
 METAIRIE, LOUISIANA 70001  
 PHONE: (504) 885-4080, FAX: (504) 885-1439  
 EMAIL: mail@ecmconsultants.com

**OWNER:**  
 HOUSING AUTHORITY  
 OF NEW ORLEANS  
 2051 SENATE ST. BUILDING B, RM. 202  
 NEW ORLEANS, LOUISIANA 70122

**PROJECT:**  
 GUSTE III COMMUNITY  
 INTERIOR & EXTERIOR REPAIRS

**SHEET TITLE:**  
 TYPICAL UNIT TYPE PLANS

DRAWN
M.L.M. & A.E.D.
CHECKED
N.G.W.
DATE
JUN. 21, 2024
SCALE
AS SHOWN
JOB NO.
22462.14
SHEET NO.

**A-116**



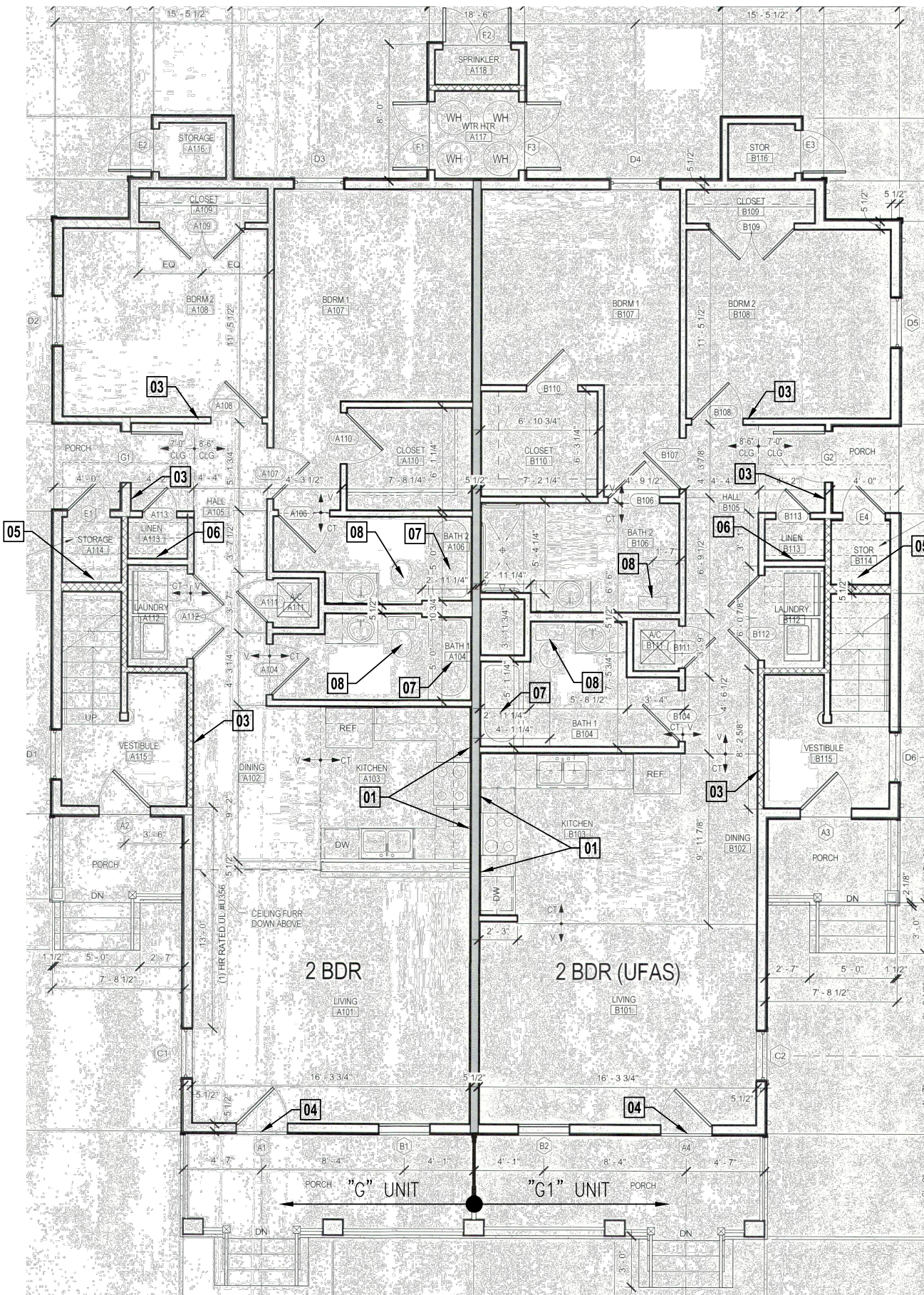

**1** TYPE G1 - 2 BDRM  
A-117 TYPICAL UNIT TYPE SCALE: N.T.S.

1215 REV JOHN RAPHAEL JR WAY  
1215 S. LIBERTY STREET  
2308 ERATO STREET

**NOTES:**

1. REFER TO SHEET A-129 FOR SCOPE OF WORK SHEETS DESCRIBING WORK TO BE PERFORMED IN GUSTE III "G1" UNITS.
2. REFER TO DETAILS ON SHEETS A-141 AND A-142 FOR ADDITIONAL INFORMATION.
3. ABOVE COUNTER OUTLETS SHALL BE MOUNTED PER CODE REQUIREMENTS.
4. OUTLETS AND SWITCHES ABOVE COUNTERS TO BE 46" A.F.F. MAX. REACH TO OUTLETS TO BE 24" AT HDPC UNITS AND 25-1/2" IN NON-HDPC UNITS.

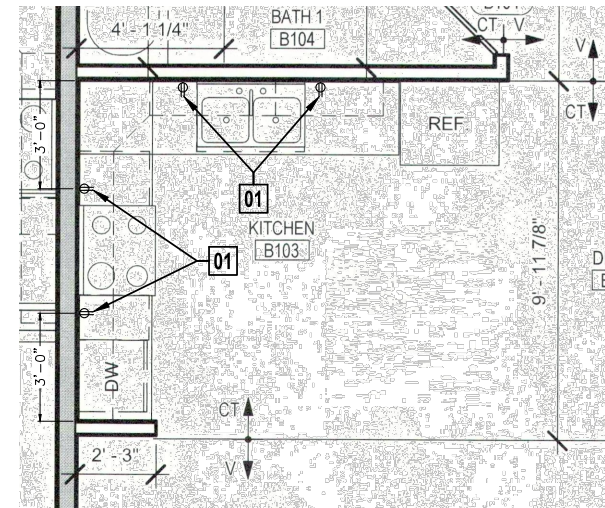

**TYPE G1 - KITCHEN OUTLET LAYOUTS**  
SCALE: 3/8" = 1'-0"

REVISIONS	BY

**ARCHITECT/ENGINEER:**  
**ECM Consultants, Inc.**  
ENGINEERS - ARCHITECTS - CONSTRUCTION MANAGERS  
1301 CLEARVIEW PKWY. SUITE 200  
METAIRIE, LOUISIANA 70001  
PHONE: (504) 885-4080, FAX: (504) 885-1439  
EMAIL: mail@ecmconsultants.com

**OWNER:**  
**HOUSING AUTHORITY OF NEW ORLEANS**  
2051 SENATE ST. BUILDING B, RM. 202  
NEW ORLEANS, LOUISIANA 70122

**PROJECT:**  
GUSTE III COMMUNITY  
INTERIOR & EXTERIOR REPAIRS

**SHEET TITLE:**  
TYPICAL UNIT TYPE PLANS

<b>DRAWN</b> M.L.M. & A.E.D.
<b>CHECKED</b> N.G.W.
<b>DATE</b> JUN. 21, 2024
<b>SCALE</b> AS SHOWN
<b>JOB NO.</b> 22462.14
<b>SHEET NO.</b>

A-117



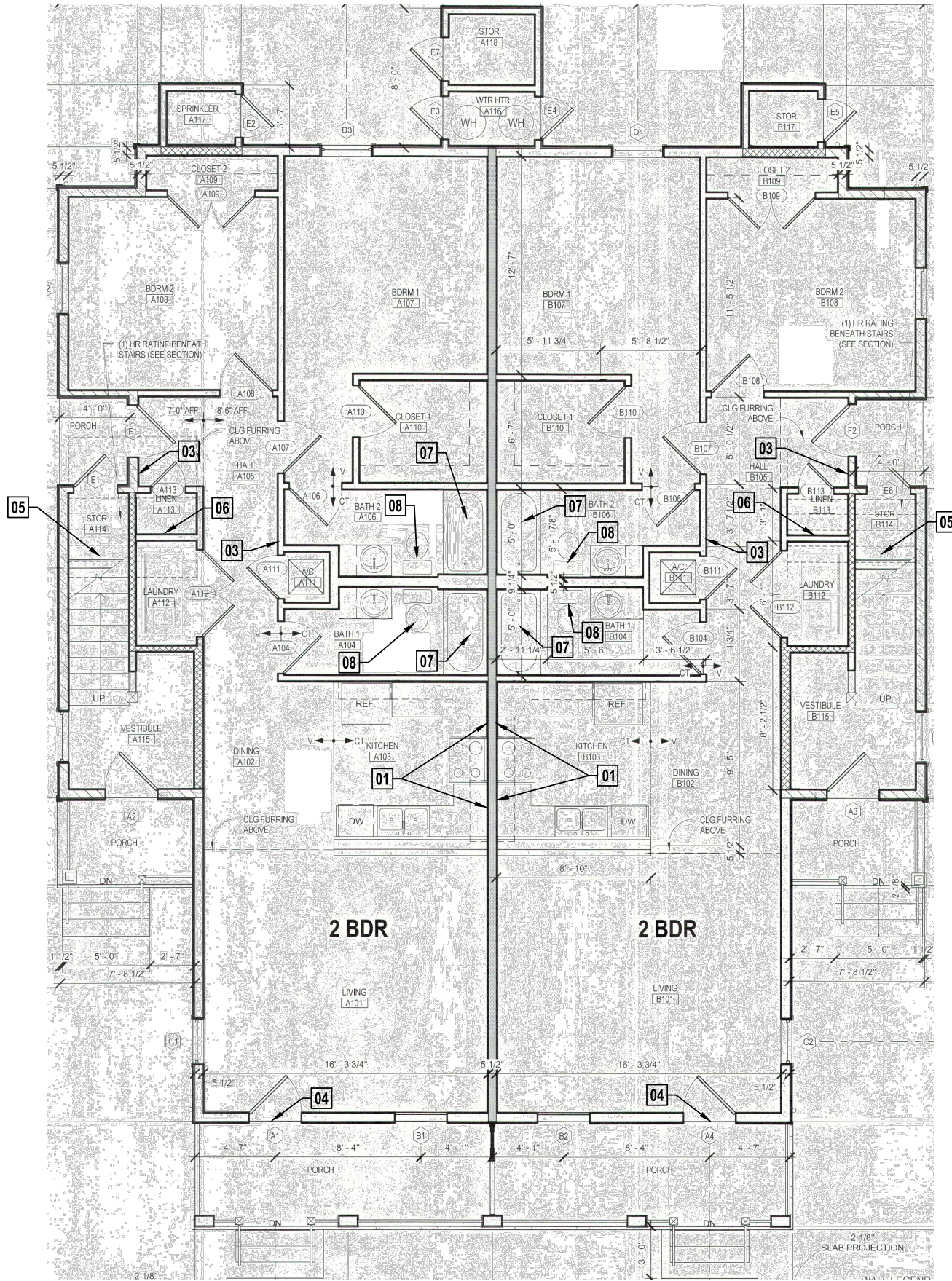

**1** TYPE H - 2 BDRM  
A-118 TYPICAL UNIT TYPE SCALE: N.T.S.

1202 FRERET STREET  
1204 FRERET STREET  
1222 REV JOHN RAPHAEL JR WAY  
1224 REV JOHN RAPHAEL JR WAY

2322 ERATO STREET  
2324 ERATO STREET

**NOTES:**

1. REFER TO SHEET A-130 FOR SCOPE OF WORK SHEETS DESCRIBING WORK TO BE PERFORMED IN GUSTE III "H" UNITS.
2. REFER TO DETAILS ON SHEETS A-141 AND A-142 FOR ADDITIONAL INFORMATION.
3. ABOVE COUNTER OUTLETS SHALL BE MOUNTED PER CODE REQUIREMENTS.
4. OUTLETS AND SWITCHES ABOVE COUNTERS TO BE 46" A.F.F. MAX. REACH TO OUTLETS TO BE 24" AT HDPC UNITS AND 25-1/2" IN NON-HDCP UNITS.

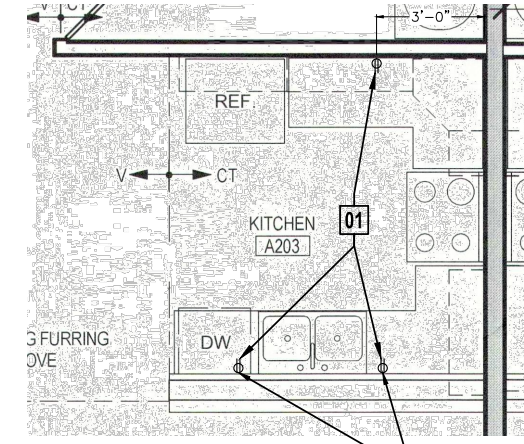

**TYPE H - KITCHEN OUTLET LAYOUTS**

SCALE: 3/8" = 1'-0"

REVISIONS	BY

**ECM Consultants, Inc.**  
ARCHITECT/ENGINEER  
ENGINEERS - ARCHITECTS - CONSTRUCTION MANAGERS  
1301 CLEARVIEW PKWY, SUITE 200  
METAIRIE, LOUISIANA 70001  
PHONE: (504) 885-4080, FAX: (504) 885-1439  
EMAIL: mail@ecmconsultants.com

**HOUSING AUTHORITY OF NEW ORLEANS**  
OWNER:  
2051 SENATE ST. BUILDING B, RM. 202  
NEW ORLEANS, LOUISIANA 70122

**PROJECT:** GUSTE III COMMUNITY INTERIOR & EXTERIOR REPAIRS  
**SHEET TITLE:** TYPICAL UNIT TYPE PLANS

DRAWN
M.L.M. & A.E.D.
CHECKED
N.G.W.
DATE
JUN. 21, 2024
SCALE
AS SHOWN
JOB NO.
22462.14
SHEET NO.

**A-118**



**SCOPE OF WORK NOTES:**

1. THE SCOPE OF WORK SHEET INCLUDED ON THIS DRAWING INDICATES THE WORK THAT IS TO BE PERFORMED IN EACH UNIT. FOR FURTHER INFORMATION ON EACH WORK AREA, REFER TO THE REFERENCE NOTES FOR ADDITIONAL DETAILS ON THE WORK AREA.

Scope of Work for		Guste III Housing Development			
"M" Bldg - Unit Type "E"		Interior - Unit #101 - 1st Floor			
#	Work Item Description	Unit	Quantity	Reference Notes	Rpt #
INT 01	Remove existing outlet next to range at both sides. Install blank plate. Relocate outlet w/extended box. Place per code.	Ea	2	See Photos 4, 5 & 8 on sheet A-143. Outlets to be 36" from corner.	# 55
INT 02	Appliances to be replaced to meet clearance.	Ea	1	See Report #40	#40
INT 03	Relocate Light Switch /Thermostat to be no more than 48" AFF to operating devices. Patch, finish and paint entire wall to match existing.	Ea	1	Relocate thermostat to 48" to operating buttons per sht G-003.	# 41
INT 04	Where indicated at existing entry/balcony doors, provide thresholds as indicated in the product data notes.	Ea	2	Refer to Product Data Notes #2 & #3 for type of threshold.	# 32

Scope of Work for		Guste III Housing Development			
"M" Bldg - Unit Type "D"		Interior - Unit #105 - 1st Floor			
#	Work Item Description	Unit	Quantity	Reference Notes	Rpt #
INT 01	Remove existing outlet next to range at both sides. Install blank plate. Relocate outlet w/extended box. Place per code.	Ea	2	See Photos 4, 5 & 8 on sheet A-143. Outlets to be 36" from corner.	# 55
INT 03	Relocate Light Switch /Thermostat to be no more than 48" AFF to operating devices. Patch, finish and paint entire wall to match existing.	Ea	1	Relocate thermostat to 48" to operating buttons per sht G-003.	# 41
INT 07	Remove existing tub & tub surround at entry bath. Install blocking in wall for future grab bars. Install new tub & surround as detailed.	LS	1	Refer to Product Data Note #7 for type of tub/tub surround.	# 39

Scope of Work for		Guste III Housing Development			
"M" Bldg - Unit Type "A"		Interior - Unit #103 - 1st Floor			
#	Work Item Description	Unit	Quantity	Reference Notes	Rpt #
INT 03	Relocate Light Switch /Thermostat to be no more than 48" AFF to operating devices. Patch, finish and paint entire wall to match existing.	Ea	1	Relocate thermostat to 48" to operating buttons per sht G-003.	# 25
INT 07	Remove existing tub & tub surround at both baths. Install blocking in wall for future grab bars. Install new tub & surround as detailed.	LS	2	Refer to Product Data Note #7 for type of tub/tub surround.	# 26
INT 09	Remove existing balcony door. Install new door as described and detailed in drawings.	LS	1	Refer to details 4, 5 & C on sheet A-141 for balcony door details.	# 24

Scope of Work for		Guste III Housing Development			
"M" Bldg - Unit Type "A"		Interior - Unit #106 - 1st Floor			
#	Work Item Description	Unit	Quantity	Reference Notes	Rpt #
INT 03	Relocate Light Switch /Thermostat to be no more than 48" AFF to operating devices. Patch, finish and paint entire wall to match existing.	Ea	1	Relocate thermostat to 48" to operating buttons per sht G-003.	# 25
INT 07	Remove existing tub & tub surround at both baths. Install blocking in wall for future grab bars. Install new tub & surround as detailed.	LS	2	Refer to Product Data Note #7 for type of tub/tub surround.	# 26

Scope of Work for		Guste III Housing Development			
"M" Bldg - Unit Type "A"		Interior - Unit #104 - 1st Floor			
#	Work Item Description	Unit	Quantity	Reference Notes	Rpt #
INT 03	Relocate Light Switch /Thermostat to be no more than 48" AFF to operating devices. Patch, finish and paint entire wall to match existing.	Ea	1	Relocate thermostat to 48" to operating buttons per sht G-003.	# 25
INT 04	Where indicated at existing entry/balcony doors, provide thresholds as indicated in the product data notes.	Ea	1	Refer to Product Data Notes #2 & #3 for type of threshold.	# 32
INT 07	Remove existing tub & tub surround at both baths. Install blocking in wall for future grab bars. Install new tub & surround as detailed.	LS	2	Refer to Product Data Note #7 for type of tub/tub surround.	# 26
INT 09	Remove existing balcony door. Install new door as described and detailed in drawings.	LS	1	Refer to details 4, 5 & C on sheet A-141 for balcony door details.	# 24

Scope of Work for		Guste III Housing Development			
"M" Bldg - Unit Type "A"		Interior - Unit #107 - 1st Floor			
#	Work Item Description	Unit	Quantity	Reference Notes	Rpt #
INT 03	Relocate Light Switch /Thermostat to be no more than 48" AFF to operating devices. Patch, finish and paint entire wall to match existing.	Ea	1	Relocate thermostat to 48" to operating buttons per sht G-003.	# 25
INT 07	Remove existing tub & tub surround at both baths. Install blocking in wall for future grab bars. Install new tub & surround as detailed.	LS	2	Refer to Product Data Note #7 for type of tub/tub surround.	# 26

REVISIONS	BY

ARCHITECT/ENGINEER:

**ECM Consultants, Inc.**

ENGINEERS - ARCHITECTS - CONSTRUCTION MANAGERS  
1301 CLEARVIEW PKWY. SUITE 200  
METAIRIE, LOUISIANA 70001  
PHONE: (504) 885-4080, FAX: (504) 885-1439  
EMAIL: mail@ecmconsultants.com

OWNER:

HOUSING AUTHORITY  
OF NEW ORLEANS

2051 SENATE ST. BUILDING B, RM. 202  
NEW ORLEANS, LOUISIANA 70122

PROJECT:

GUSTE III COMMUNITY  
INTERIOR & EXTERIOR REPAIRS

SHEET TITLE:

SCOPE OF WORK SHEETS FOR  
("M" BLDG.) FIRST FLOOR UNITS

DRAWN
M.L.M. & A.E.D.
CHECKED
N.G.W.
DATE
JUN. 21, 2024
SCALE
AS SHOWN
JOB NO.
22462.14
SHEET NO.

**SCOPE OF WORK NOTES:**

1. THE SCOPE OF WORK SHEET INCLUDED ON THIS DRAWING INDICATES THE WORK THAT IS TO BE PERFORMED IN EACH UNIT. FOR FURTHER INFORMATION ON EACH WORK AREA, REFER TO THE REFERENCE NOTES FOR ADDITIONAL DETAILS ON THE WORK AREA.

Scope of Work for		Guste III Housing Development			
"M" Bldg - Unit Type "A"		Interior - Unit #108 - 1st Floor			
#	Work Item Description	Unit	Quantity	Reference Notes	Rpt #
INT 03	Relocate Light Switch /Thermostat to be no more than 48" AFF to operating devices. Patch, finish and paint entire wall to match existing.	Ea	1	Relocate thermostat to 48" to operating buttons per sht G-003.	# 25
INT 07	Remove existing tub & tub surround at both baths. Install blocking in wall for future grab bars. Install new tub & surround as detailed.	LS	2	Refer to Product Data Note #7 for type of tub/tub surround.	# 26

Scope of Work for		Guste III Housing Development			
"M" Bldg - Unit Type "A"		Interior - Unit #111 - 1st Floor			
#	Work Item Description	Unit	Quantity	Reference Notes	Rpt #
INT 03	Relocate Light Switch /Thermostat to be no more than 48" AFF to operating devices. Patch, finish and paint entire wall to match existing.	Ea	4	Relocate thermostat to 48" to operating buttons per sht G-003.	# 25
INT 07	Remove existing tub & tub surround at both baths. Install blocking in wall for future grab bars. Install new tub & surround as detailed.	LS	2	Refer to Product Data Note #7 for type of tub/tub surround.	# 26

Scope of Work for		Guste III Housing Development			
"M" Bldg - Unit Type "A"		Interior - Unit #109 - 1st Floor			
#	Work Item Description	Unit	Quantity	Reference Notes	Rpt #
INT 04	Where indicated at existing entry/balcony doors, provide thresholds as indicated in the product data notes.	Ea	1	Refer to Product Data Notes #2 & #3 for type of threshold.	# 32
INT 07	Remove existing tub & tub surround at both baths. Install blocking in wall for future grab bars. Install new tub & surround as detailed.	LS	2	Refer to Product Data Note #7 for type of tub/tub surround.	# 26
INT 09	Remove existing balcony door. Install new door as described and detailed in drawings.	LS	1	Refer to details 4, 5 & C on sheet A-141 for balcony door details.	# 24

Scope of Work for		Guste III Housing Development			
"M" Bldg - Unit Type "C"		Interior - Unit #112 - 1st Floor			
#	Work Item Description	Unit	Quantity	Reference Notes	Rpt #
INT 01	Remove existing outlet next to range at both sides. Install blank plate. Relocate outlet w/extended box. Place per code.	Ea	2	See Photos 4, 5 & 8 on sheet A-143. Outlets to be 36" from corner.	# 55
INT 03	Relocate Light Switch /Thermostat to be no more than 48" AFF to operating devices. Patch, finish and paint entire wall to match existing.	Ea	1	Relocate thermostat to 48" to operating buttons per sht G-003.	# 34
INT 04	Where indicated at existing entry/balcony doors, provide thresholds as indicated in the product data notes.	Ea	1	Refer to Product Data Notes #2 & #3 for type of threshold.	# 32,33
INT 07	Remove existing tub & tub surround at both baths. Install blocking in wall for future grab bars. Install new tub & surround as detailed.	LS	2	Refer to Product Data Note #7 for type of tub/tub surround.	# 35

Scope of Work for		Guste III Housing Development			
"M" Bldg - Unit Type "A"		Interior - Unit #110 - 1st Floor			
#	Work Item Description	Unit	Quantity	Reference Notes	Rpt #
INT 03	Relocate Light Switch /Thermostat to be no more than 48" AFF to operating devices. Patch, finish and paint entire wall to match existing.	Ea	1	Relocate thermostat to 48" to operating buttons per sht G-003.	# 25
INT 04	Where indicated at existing entry/balcony doors, provide thresholds as indicated in the product data notes.	Ea	1	Refer to Product Data Notes #2 & #3 for type of threshold.	# 32
INT 07	Remove existing tub & tub surround at both baths. Install blocking in wall for future grab bars. Install new tub & surround as detailed.	LS	2	Refer to Product Data Note #7 for type of tub/tub surround.	# 26
INT 09	Remove existing balcony door. Install new door as described and detailed in drawings.	LS	1	Refer to details 4, 5 & C on sheet A-141 for balcony door details.	# 24

Scope of Work for		Guste III Housing Development			
"M" Bldg - Unit Type "B"		Interior - Unit #113 - 1st Floor			
#	Work Item Description	Unit	Quantity	Reference Notes	Rpt #
INT 01	Remove existing outlet next to range at both sides. Install blank plate. Relocate outlet w/extended box. Place per code.	Ea	2	See Photos 4, 5 & 8 on sheet A-143. Outlets to be 36" from corner.	# 55
INT 03	Relocate Light Switch /Thermostat to be no more than 48" AFF to operating devices. Patch, finish and paint entire wall to match existing.	Ea	1	Relocate thermostat to 48" to operating buttons per sht G-003.	# 31
INT 04	Where indicated at existing entry/balcony doors, provide thresholds as indicated in the product data notes.	Ea	2	Refer to Product Data Note #3 for type of threshold.	# 32
INT 08	Remove Toilet. Provide offset flange or reroute piping to move toilet to be 18" from centerline of toilet. Patch ceramic floor tile as required.	Ea	1	Entry Toilet at 19-1/2".	# 27

REVISIONS	BY

ARCHITECT/ENGINEER:

**ECM Consultants, Inc.**  
ENGINEERS - ARCHITECTS - CONSTRUCTION MANAGERS  
1301 CLEARVIEW PKWY. SUITE 200  
METAIRIE, LOUISIANA 70001  
PHONE: (504) 885-4080. FAX: (504) 885-1439  
EMAIL: mail@ecmconsultants.com

OWNER:

HOUSING AUTHORITY  
OF NEW ORLEANS  
2051 SENATE ST. BUILDING B, RM. 202  
NEW ORLEANS, LOUISIANA 70122

PROJECT:

GUSTE III COMMUNITY  
INTERIOR & EXTERIOR REPAIRS

SHEET TITLE:

SCOPE OF WORK SHEETS FOR  
("M" BLDG.) FIRST FLOOR UNITS

DRAWN
M.L.M. & A.E.D.
CHECKED
N.G.W.
DATE
JUN. 21, 2024
SCALE
AS SHOWN
JOB NO.
22462.14
SHEET NO.



Scope of Work for		Guste III Housing Development			
"M" Bldg - Unit Type "F"		Interior - Unit #201 - 2nd Floor			
#	Work Item Description	Unit	Quantity	Reference Notes	Rpt #
INT 01	Remove existing outlet next to range at both sides. Install blank plate. Relocate outlet w/extended box. Place per code.	Ea	2	See Photos 4, 5 & 8 on sheet A-143. Outlets to be 36" from corner.	# 55
INT 04	Where indicated at existing entry/balcony doors, provide thresholds as indicated in the product data notes.	Ea	2	Refer to Product Data Notes #2 & #3 for type of threshold.	# 32

Scope of Work for		Guste III Housing Development			
"M" Bldg - Unit Type "G"		Interior - Unit #202 - 2nd Floor			
#	Work Item Description	Unit	Quantity	Reference Notes	Rpt #
INT 01	Remove existing outlet next to range at both sides. Install blank plate. Relocate outlet w/extended box. Place per code.	Ea	2	See Photos 4, 5 & 8 on sheet A-143. Outlets to be 36" from corner.	# 55
INT 03	Relocate Light Switch /Thermostat to be no more than 48" AFF to operating devices. Patch, finish and paint entire wall to match existing.	Ea	1	Relocate thermostat to 48" to operating buttons per sht G-003.	# 41

Scope of Work for		Guste III Housing Development			
"M" Bldg - Unit Type "A"		Interior - Unit #203 - 2nd Floor			
#	Work Item Description	Unit	Quantity	Reference Notes	Rpt #
INT 04	Where indicated at existing entry/balcony doors, provide thresholds as indicated in the product data notes.	Ea	1	Refer to Product Data Notes #2 & #3 for type of threshold.	# 32
INT 07	Remove existing tub & tub surround at both baths. Install blocking in wall for future grab bars. Install new tub & surround as detailed.	LS	2	Refer to Product Data Note #7 for type of tub/tub surround.	# 26
INT 08	Remove Toilet. Provide offset flange or reroute piping to move toilet to be 18" from centerline of toilet. Patch ceramic floor tile as required.	Ea	1	Bed Toilet at 19".	# 27

Scope of Work for		Guste III Housing Development			
"M" Bldg - Unit Type "A"		Interior - Unit #204 - 2nd Floor			
#	Work Item Description	Unit	Quantity	Reference Notes	Rpt #
INT 03	Relocate Light Switch /Thermostat to be no more than 48" AFF to operating devices. Patch, finish and paint entire wall to match existing.	Ea	1	Relocate thermostat to 48" to operating buttons per sht G-003.	# 25
INT 04	Where indicated at existing entry/balcony doors, provide thresholds as indicated in the product data notes.	Ea	1	Refer to Product Data Note #3 for type of threshold.	# 32
INT 07	Remove existing tub & tub surround at both baths. Install blocking in wall for future grab bars. Install new tub & surround as detailed.	LS	2	Refer to Product Data Note #7 for type of tub/tub surround.	# 26
INT 09	Remove existing balcony door. Install new door as described and detailed in drawings.	LS	1	Refer to details 4, 5 & C on sheet A-141 for balcony door details.	# 24

Scope of Work for		Guste III Housing Development			
"M" Bldg - Unit Type "D"		Interior - Unit #205 - 2nd Floor			
#	Work Item Description	Unit	Quantity	Reference Notes	Rpt #
INT 01	Remove existing outlet next to range at both sides. Install blank plate. Relocate outlet w/extended box. Place per code.	Ea	2	See Photos 4, 5 & 8 on sheet A-143. Outlets to be 36" from corner.	# 55
INT 04	Where indicated at existing entry/balcony doors, provide thresholds as indicated in the product data notes.	Ea	1	Refer to Product Data Notes #2 & #3 for type of threshold.	# 37,38
INT 07	Remove existing tub & tub surround at entry bath. Install blocking in wall for future grab bars. Install new tub & surround as detailed.	LS	1	Refer to Product Data Note #7 for type of tub/tub surround.	# 39

Scope of Work for		Guste III Housing Development			
"M" Bldg - Unit Type "A"		Interior - Unit #206 - 2nd Floor			
#	Work Item Description	Unit	Quantity	Reference Notes	Rpt #
INT 01	Remove existing outlet next to range at both sides. Install blank plate. Relocate outlet w/extended box. Place per code.	Ea	2	See Photos 4, 5 & 8 on sheet A-143. Outlets to be 36" from corner.	# 55
INT 04	Where indicated at existing entry/balcony doors, provide thresholds as indicated in the product data notes.	Ea	1	Refer to Product Data Note #3 for type of threshold.	# 32
INT 07	Remove existing tub & tub surround at both baths. Install blocking in wall for future grab bars. Install new tub & surround as detailed.	LS	2	Refer to Product Data Note #7 for type of tub/tub surround.	# 26

Scope of Work for		Guste III Housing Development			
"M" Bldg - Unit Type "A"		Interior - Unit #207 - 2nd Floor			
#	Work Item Description	Unit	Quantity	Reference Notes	Rpt #
INT 03	Relocate Light Switch /Thermostat to be no more than 48" AFF to operating devices. Patch, finish and paint entire wall to match existing.	Ea	1	Relocate thermostat to 48" to operating buttons per sht G-003.	# 25
INT 04	Where indicated at existing entry/balcony doors, provide thresholds as indicated in the product data notes.	Ea	1	Refer to Product Data Notes #2 & #3 for type of threshold.	# 32
INT 07	Remove existing tub & tub surround at both baths. Install blocking in wall for future grab bars. Install new tub & surround as detailed.	LS	2	Refer to Product Data Note #7 for type of tub/tub surround.	# 26
INT 08	Remove Toilet. Provide offset flange or reroute piping to move toilet to be 18" from centerline of toilet. Patch ceramic floor tile as required.	Ea	1	Entry Toilet at 19".	# 27

**SCOPE OF WORK NOTES:**

1. THE SCOPE OF WORK SHEET INCLUDED ON THIS DRAWING INDICATES THE WORK THAT IS TO BE PERFORMED IN EACH UNIT. FOR FURTHER INFORMATION ON EACH WORK AREA, REFER TO THE REFERENCE NOTES FOR ADDITIONAL DETAILS ON THE WORK AREA.

REVISIONS	BY

ARCHITECT/ENGINEER:

**ECM Consultants, Inc.**  
ENGINEERS - ARCHITECTS - CONSTRUCTION MANAGERS  
1301 CLEARVIEW PKWY. SUITE 200  
METAIRIE, LOUISIANA 70001  
PHONE: (504) 885-4080. FAX: (504) 885-1439  
EMAIL: mail@ecmconsultants.com

OWNER:

HOUSING AUTHORITY  
OF NEW ORLEANS  
2051 SENATE ST. BUILDING B. RM. 202  
NEW ORLEANS, LOUISIANA 70122

PROJECT:

GUSTE III COMMUNITY  
INTERIOR & EXTERIOR REPAIRS

SHEET TITLE:

SCOPE OF WORK SHEETS FOR  
("M" BLDG.) SECOND FLOOR UNITS

DRAWN
M.L.M. & A.E.D.
CHECKED
N.G.W.
DATE
JUN. 21, 2024
SCALE
AS SHOWN
JOB NO.
22462.14
SHEET NO.

**SCOPE OF WORK NOTES:**

1. THE SCOPE OF WORK SHEET INCLUDED ON THIS DRAWING INDICATES THE WORK THAT IS TO BE PERFORMED IN EACH UNIT. FOR FURTHER INFORMATION ON EACH WORK AREA, REFER TO THE REFERENCE NOTES FOR ADDITIONAL DETAILS ON THE WORK AREA.

Scope of Work for		Guste III Housing Development			
"M" Bldg - Unit Type "A"		Interior - Unit #208 - 2nd Floor			
#	Work Item Description	Unit	Quantity	Reference Notes	Rpt #
INT 03	Relocate Light Switch /Thermostat to be no more than 48" AFF to operating devices. Patch, finish and paint entire wall to match existing.	Ea	1	Relocate thermostat to 48" to operating buttons per sht G-003.	# 25
INT 04	Where indicated at existing entry/balcony doors, provide thresholds as indicated in the product data notes.	Ea	1	Refer to Product Data Notes #2 & #3 for type of threshold.	# 32
INT 07	Remove existing tub & tub surround at both baths. Install blocking in wall for future grab bars. Install new tub & surround as detailed.	LS	2	Refer to Product Data Note #7 for type of tub/tub surround.	# 26

Scope of Work for		Guste III Housing Development			
"M" Bldg - Unit Type "A"		Interior - Unit #209 - 2nd Floor			
#	Work Item Description	Unit	Quantity	Reference Notes	Rpt #
INT 04	Where indicated at existing entry/balcony doors, provide thresholds as indicated in the product data notes.	Ea	1	Refer to Product Data Notes #2 & #3 for type of threshold.	# 32
INT 07	Remove existing tub & tub surround at both baths. Install blocking in wall for future grab bars. Install new tub & surround as detailed.	LS	2	Refer to Product Data Note #7 for type of tub/tub surround.	# 26
INT 09	Remove existing balcony door. Install new door as described and detailed in drawings.	LS	1	Refer to details 4, 5 & C on sheet A-141 for balcony door details.	# 24

Scope of Work for		Guste III Housing Development			
"M" Bldg - Unit Type "A"		Interior - Unit #210 - 2nd Floor			
#	Work Item Description	Unit	Quantity	Reference Notes	Rpt #
INT 03	Relocate Light Switch /Thermostat to be no more than 48" AFF to operating devices. Patch, finish and paint entire wall to match existing.	Ea	1	Relocate thermostat to 48" to operating buttons per sht G-003.	# 25
INT 04	Where indicated at existing entry/balcony doors, provide thresholds as indicated in the product data notes.	Ea	1	Refer to Product Data Notes #2 & #3 for type of threshold.	# 32
INT 07	Remove existing tub & tub surround at both baths. Install blocking in wall for future grab bars. Install new tub & surround as detailed.	LS	2	Refer to Product Data Note #7 for type of tub/tub surround.	# 26
INT 09	Remove existing balcony door. Install new door as described and detailed in drawings.	LS	1	Refer to details 4, 5 & C on sheet A-141 for balcony door details.	# 24

Scope of Work for		Guste III Housing Development			
"M" Bldg - Unit Type "A"		Interior - Unit #211 - 2nd Floor			
#	Work Item Description	Unit	Quantity	Reference Notes	Rpt #
INT 04	Where indicated at existing entry/balcony doors, provide thresholds as indicated in the product data notes.	Ea	1	Refer to Product Data Notes #2 & #3 for type of threshold.	# 32
INT 07	Remove existing tub & tub surround at both baths. Install blocking in wall for future grab bars. Install new tub & surround as detailed.	LS	2	Refer to Product Data Note #7 for type of tub/tub surround.	# 26

Scope of Work for		Guste III Housing Development			
"M" Bldg - Unit Type "C"		Interior - Unit #212 - 2nd Floor			
#	Work Item Description	Unit	Quantity	Reference Notes	Rpt #
INT 01	Remove existing outlet next to range at both sides. Install blank plate. Relocate outlet w/extended box. Place per code.	Ea	2	See Photos 4, 5 & 8 on sheet A-143. Outlets to be 36" from corner.	# 55
INT 04	Where indicated at existing entry/balcony doors, provide thresholds as indicated in the product data notes.	Ea	1	Refer to Product Data Notes #2 & #3 for type of threshold.	# 32,33
INT 07	Remove existing tub & tub surround at both baths. Install blocking in wall for future grab bars. Install new tub & surround as detailed.	LS	2	Refer to Product Data Note #7 for type of tub/tub surround.	# 35

Scope of Work for		Guste III Housing Development			
"M" Bldg - Unit Type "B"		Interior - Unit #213 - 2nd Floor			
#	Work Item Description	Unit	Quantity	Reference Notes	Rpt #
INT 01	Remove existing outlet next to range at both sides. Install blank plate. Relocate outlet w/extended box. Place per code.	Ea	2	See Photos 4, 5 & 8 on sheet A-143. Outlets to be 36" from corner.	# 55
INT 03	Relocate Light Switch /Thermostat to be no more than 48" AFF to operating devices. Patch, finish and paint entire wall to match existing.	Ea	1	Relocate thermostat to 48" to operating buttons per sht G-003.	# 31
INT 04	Where indicated at existing entry/balcony doors, provide thresholds as indicated in the product data notes.	Ea	1	Refer to Product Data Notes #2 & #3 for type of threshold.	# 32

REVISIONS	BY

ARCHITECT/ENGINEER:

**ECM Consultants, Inc.**  
ENGINEERS - ARCHITECTS - CONSTRUCTION MANAGERS  
1301 CLEARVIEW PKWY. SUITE 200  
METAIRIE, LOUISIANA 70001  
PHONE: (504) 885-4080. FAX: (504) 885-1439  
EMAIL: mail@ecmconsultants.com

OWNER:

HOUSING AUTHORITY  
OF NEW ORLEANS  
2051 SENATE ST. BUILDING B, RM. 202  
NEW ORLEANS, LOUISIANA 70122

PROJECT:

GUSTE III COMMUNITY  
INTERIOR & EXTERIOR REPAIRS

SHEET TITLE:  
SCOPE OF WORK SHEETS FOR  
("M" BLDG.) SECOND FLOOR UNITS

DRAWN
M.L.M. & A.E.D.
CHECKED
N.G.W.
DATE
JUN. 21, 2024
SCALE
AS SHOWN
JOB NO.
22462.14
SHEET NO.

Scope of Work for		Guste III Housing Development			
"M" Bldg - Unit Type "H"		Interior - Unit #301 - 3rd Floor			
#	Work Item Description	Unit	Quantity	Reference Notes	Rpt #
INT 01	Remove existing outlet next to range at both sides. Install blank plate. Relocate outlet w/extended box. Place per code.	Ea	2	See Photos 4, 5 & 8 on sheet A-143. Outlets to be 36" from corner.	# 55
INT 03	Relocate Light Switch /Thermostat to be no more than 48" AFF to operating devices. Patch, finish and paint entire wall to match existing.	Ea	1	Relocate thermostat to 48" to operating buttons per sht G-003.	# 41
INT 04	Where indicated at existing entry/balcony doors, provide thresholds as indicated in the product data notes.	Ea	2	Refer to Product Data Notes #2 & #3 for type of threshold.	# 42
INT 07	Remove existing tub & tub surround at both baths. Install blocking in wall for future grab bars. Install new tub & surround as detailed.	LS	2	Refer to Product Data Note #7 for type of tub/tub surround.	# 44

Scope of Work for		Guste III Housing Development			
"M" Bldg - Unit Type "J"		Interior - Unit #302 - 3rd Floor			
#	Work Item Description	Unit	Quantity	Reference Notes	Rpt #
INT 01	Remove existing outlet next to range at both sides. Install blank plate. Relocate outlet w/extended box. Place per code.	Ea	2	See Photos 4, 5 & 8 on sheet A-143. Outlets to be 36" from corner.	# 55
INT 03	Relocate Light Switch /Thermostat to be no more than 48" AFF to operating devices. Patch, finish and paint entire wall to match existing.	Ea	1	Relocate thermostat to 48" to operating buttons per sht G-003.	# 41
INT 04	Where indicated at existing entry/balcony doors, provide thresholds as indicated in the product data notes.	Ea	1	Refer to Product Data Notes #2 & #3 for type of threshold.	# 32
INT 07	Remove existing tub & tub surround at both baths. Install blocking in wall for future grab bars. Install new tub & surround as detailed.	LS	2	Refer to Product Data Note #7 for type of tub/tub surround.	# 46
INT 10	Remove Lav and Vanity Cabinet. Provide new lav, faucet & vanity to locate center of lav to be no less than 15" from sidewall. Replace cultured marble countertop.	LS	1	Refer to Product Data Note #6 for type of items to provide.	# 47

Scope of Work for		Guste III Housing Development			
"M" Bldg - Unit Type "A"		Interior - Unit #303 - 3rd Floor			
#	Work Item Description	Unit	Quantity	Reference Notes	Rpt #
INT 03	Relocate Light Switch /Thermostat to be no more than 48" AFF to operating devices. Patch, finish and paint entire wall to match existing.	Ea	1	Relocate thermostat to 48" to operating buttons per sht G-003.	# 25
INT 04	Where indicated at existing entry/balcony doors, provide thresholds as indicated in the product data notes.	Ea	1	Refer to Product Data Notes #2 & #3 for type of threshold.	# 32
INT 07	Remove existing tub & tub surround at both baths. Install blocking in wall for future grab bars. Install new tub & surround as detailed.	LS	2	Refer to Product Data Note #7 for type of tub/tub surround.	# 26
INT 08	Remove Toilet. Provide offset flange or reroute piping to move toilet to be 18" from centerline of toilet. Patch ceramic floor tile as required.	Ea	1	Entry Toilet at 19".	# 27

Scope of Work for		Guste III Housing Development			
"M" Bldg - Unit Type "A"		Interior - Unit #304 - 3rd Floor			
#	Work Item Description	Unit	Quantity	Reference Notes	Rpt #
INT 03	Relocate Light Switch /Thermostat to be no more than 48" AFF to operating devices. Patch, finish and paint entire wall to match existing.	Ea	1	Relocate thermostat to 48" to operating buttons per sht G-003.	# 25
INT 04	Where indicated at existing entry/balcony doors, provide thresholds as indicated in the product data notes.	Ea	1	Refer to Product Data Notes #2 & #3 for type of threshold.	# 32
INT 07	Remove existing tub & tub surround at both baths. Install blocking in wall for future grab bars. Install new tub & surround as detailed.	LS	2	Refer to Product Data Note #7 for type of tub/tub surround.	# 26
INT 08	Remove Toilet. Provide offset flange or reroute piping to move toilet to be 18" from centerline of toilet. Patch ceramic floor tile as required.	Ea	2	Entry Toilet at 19". Bath Toilet at 20".	# 27
INT 09	Remove existing balcony door. Install new door as described and detailed in drawings.	LS	1	Refer to details 4, 5 & C on sheet A-141 for balcony door details.	# 24

Scope of Work for		Guste III Housing Development			
"M" Bldg - Unit Type "D"		Interior - Unit #305 - 3rd Floor			
#	Work Item Description	Unit	Quantity	Reference Notes	Rpt #
INT 03	Relocate Light Switch /Thermostat to be no more than 48" AFF to operating devices. Patch, finish and paint entire wall to match existing.	Ea	1	Relocate thermostat to 48" to operating buttons per sht G-003.	# 41
INT 04	Where indicated at existing entry/balcony doors, provide thresholds as indicated in the product data notes.	Ea	1	Refer to Product Data Notes #2 & #3 for type of threshold.	# 37,38
INT 07	Remove existing tub & tub surround at entry bath. Install blocking in wall for future grab bars. Install new tub & surround as detailed.	LS	1	Refer to Product Data Note #7 for type of tub/tub surround.	# 39

Scope of Work for		Guste III Housing Development			
"M" Bldg - Unit Type "A"		Interior - Unit #306 - 3rd Floor			
#	Work Item Description	Unit	Quantity	Reference Notes	Rpt #
INT 03	Relocate Light Switch /Thermostat to be no more than 48" AFF to operating devices. Patch, finish and paint entire wall to match existing.	Ea	1	Relocate thermostat to 48" to operating buttons per sht G-003.	# 25
INT 04	Where indicated at existing entry/balcony doors, provide thresholds as indicated in the product data notes.	Ea	1	Refer to Product Data Notes #2 & #3 for type of threshold.	# 32
INT 07	Remove existing tub & tub surround at both baths. Install blocking in wall for future grab bars. Install new tub & surround as detailed.	LS	2	Refer to Product Data Note #7 for type of tub/tub surround.	# 26
INT 09	Remove existing balcony door. Install new door as described and detailed in drawings.	LS	1	Refer to details 4, 5 & C on sheet A-141 for balcony door details.	# 24

Scope of Work for		Guste III Housing Development			
"M" Bldg - Unit Type "A"		Interior - Unit #307 - 3rd Floor			
#	Work Item Description	Unit	Quantity	Reference Notes	Rpt #
INT 04	Where indicated at existing entry/balcony doors, provide thresholds as indicated in the product data notes.	Ea	1	Refer to Product Data Notes #2 & #3 for type of threshold.	# 32
INT 07	Remove existing tub & tub surround at both baths. Install blocking in wall for future grab bars. Install new tub & surround as detailed.	LS	2	Refer to Product Data Note #7 for type of tub/tub surround.	# 26

**SCOPE OF WORK NOTES:**

1. THE SCOPE OF WORK SHEET INCLUDED ON THIS DRAWING INDICATES THE WORK THAT IS TO BE PERFORMED IN EACH UNIT. FOR FURTHER INFORMATION ON EACH WORK AREA, REFER TO THE REFERENCE NOTES FOR ADDITIONAL DETAILS ON THE WORK AREA.

REVISIONS	BY

**ECM Consultants, Inc.**  
 ARCHITECT/ENGINEER:  
 ENGINEERS - ARCHITECTS - CONSTRUCTION MANAGERS  
 1301 CLEARVIEW PKWY. SUITE 200  
 METAIRIE, LOUISIANA 70001  
 PHONE: (504) 885-4080. FAX: (504) 885-1439  
 EMAIL: mail@ecmconsultants.com

OWNER:  
 HOUSING AUTHORITY  
 OF NEW ORLEANS  
 2051 SENATE ST. BUILDING B, RM. 202  
 NEW ORLEANS, LOUISIANA 70122

PROJECT:  
 GUSTE III COMMUNITY  
 INTERIOR & EXTERIOR REPAIRS  
 SHEET TITLE:  
 SCOPE OF WORK SHEETS FOR  
 ("M" BLDG.) THIRD FLOOR UNITS

DRAWN  
 M.L.M. & A.E.D.  
 CHECKED  
 N.G.W.  
 DATE  
 JUN. 21, 2024  
 SCALE  
 AS SHOWN  
 JOB NO.  
 22462.14  
 SHEET NO.

**SCOPE OF WORK NOTES:**

1. THE SCOPE OF WORK SHEET INCLUDED ON THIS DRAWING INDICATES THE WORK THAT IS TO BE PERFORMED IN EACH UNIT. FOR FURTHER INFORMATION ON EACH WORK AREA, REFER TO THE REFERENCE NOTES FOR ADDITIONAL DETAILS ON THE WORK AREA.

Scope of Work for		Guste III Housing Development			
"M" Bldg - Unit Type "A"		Interior - Unit #308 - 3rd Floor			
#	Work Item Description	Unit	Quantity	Reference Notes	Rpt #
INT 04	Where indicated at existing entry/balcony doors, provide thresholds as indicated in the product data notes.	Ea	1	Refer to Product Data Notes #2 & #3 for type of threshold.	# 32
INT 07	Remove existing tub & tub surround at both baths. Install blocking in wall for future grab bars. Install new tub & surround as detailed.	LS	2	Refer to Product Data Note #7 for type of tub/tub surround.	# 26

Scope of Work for		Guste III Housing Development			
"M" Bldg - Unit Type "A"		Interior - Unit #311 - 3rd Floor			
#	Work Item Description	Unit	Quantity	Reference Notes	Rpt #
INT 04	Where indicated at existing entry/balcony doors, provide thresholds as indicated in the product data notes.	Ea	1	Refer to Product Data Notes #2 & #3 for type of threshold.	# 32
INT 07	Remove existing tub & tub surround at both baths. Install blocking in wall for future grab bars. Install new tub & surround as detailed.	LS	2	Refer to Product Data Note #7 for type of tub/tub surround.	# 26

Scope of Work for		Guste III Housing Development			
"M" Bldg - Unit Type "A"		Interior - Unit #309 - 3rd Floor			
#	Work Item Description	Unit	Quantity	Reference Notes	Rpt #
INT 04	Where indicated at existing entry/balcony doors, provide thresholds as indicated in the product data notes.	Ea	1	Refer to Product Data Notes #2 & #3 for type of threshold.	# 32
INT 07	Remove existing tub & tub surround at both baths. Install blocking in wall for future grab bars. Install new tub & surround as detailed.	LS	2	Refer to Product Data Note #7 for type of tub/tub surround.	# 26
INT 08	Remove Toilet. Provide offset flange or reroute piping to move toilet to be 18" from centerline of toilet. Patch ceramic floor tile as required.	Ea	1	Entry Toilet at 15"	# 27
INT 09	Remove existing balcony door. Install new door as described and detailed in drawings.	LS	1	Refer to details 4, 5 & C on sheet A-141 for balcony door details.	# 24

Scope of Work for		Guste III Housing Development			
"M" Bldg - Unit Type "C"		Interior - Unit #312 - 3rd Floor			
#	Work Item Description	Unit	Quantity	Reference Notes	Rpt #
INT 01	Remove existing outlet next to range at both sides. Install blank plate. Relocate outlet w/extended box. Place per code.	Ea	2	See Photos 4, 5 & 8 on sheet A-143. Outlets to be 36" from corner.	# 55
INT 04	Where indicated at existing entry/balcony doors, provide thresholds as indicated in the product data notes.	Ea	1	Refer to Product Data Notes #2 & #3 for type of threshold.	# 32,33
INT 07	Remove existing tub & tub surround at both baths. Install blocking in wall for future grab bars. Install new tub & surround as detailed.	LS	2	Refer to Product Data Note #7 for type of tub/tub surround.	# 35
INT 08	Remove Toilet. Provide offset flange or reroute piping to move toilet to be 18" from centerline of toilet. Patch ceramic floor tile as required.	Ea	2	Entry Toilet at 19". Hall Toilet at 19".	# 36

Scope of Work for		Guste III Housing Development			
"M" Bldg - Unit Type "A"		Interior - Unit #310 - 3rd Floor			
#	Work Item Description	Unit	Quantity	Reference Notes	Rpt #
INT 04	Where indicated at existing entry/balcony doors, provide thresholds as indicated in the product data notes.	Ea	1	Refer to Product Data Notes #2 & #3 for type of threshold.	# 32
INT 07	Remove existing tub & tub surround at both baths. Install blocking in wall for future grab bars. Install new tub & surround as detailed.	LS	2	Refer to Product Data Note #7 for type of tub/tub surround.	# 26
INT 09	Remove existing balcony door. Install new door as described and detailed in drawings.	LS	1	Refer to details 4, 5 & C on sheet A-141 for balcony door details.	# 24

Scope of Work for		Guste III Housing Development			
"M" Bldg - Unit Type "B"		Interior - Unit #313 - 3rd Floor			
#	Work Item Description	Unit	Quantity	Reference Notes	Rpt #
INT 01	Remove existing outlet next to range at both sides. Install blank plate. Relocate outlet w/extended box. Place per code.	Ea	2	See Photos 4, 5 & 8 on sheet A-143. Outlets to be 36" from corner.	# 55
INT 03	Relocate Light Switch /Thermostat to be no more than 48" AFF to operating devices. Patch, finish and paint entire wall to match existing.	Ea	1	Relocate thermostat to 48" to operating buttons per sht G-003.	# 31
INT 04	Where indicated at existing entry/balcony doors, provide thresholds as indicated in the product data notes.	Ea	1	Refer to Product Data Notes #2 & #3 for type of threshold.	# 32
INT 08	Remove Toilet. Provide offset flange or reroute piping to move toilet to be 18" from centerline of toilet. Patch ceramic floor tile as required.	Ea	1	Hall Toilet at 19".	# 27

REVISIONS	BY

ARCHITECT/ENGINEER:

**ECM Consultants, Inc.**  
ENGINEERS - ARCHITECTS - CONSTRUCTION MANAGERS  
1301 CLEARVIEW PKWY. SUITE 200  
METAIRIE, LOUISIANA 70001  
PHONE: (504) 885-4080. FAX: (504) 885-1439  
EMAIL: mail@ecmconsultants.com

OWNER:

HOUSING AUTHORITY  
OF NEW ORLEANS  
2051 SENATE ST. BUILDING B, RM. 202  
NEW ORLEANS, LOUISIANA 70122

PROJECT:

GUSTE III COMMUNITY  
INTERIOR & EXTERIOR REPAIRS

SHEET TITLE:

SCOPE OF WORK SHEETS FOR  
("M" BLDG.) THIRD FLOOR UNITS

DRAWN
M.L.M. & A.E.D.
CHECKED
N.G.W.
DATE
JUN. 21, 2024
SCALE
AS SHOWN
JOB NO.
22462.14
SHEET NO.

**SCOPE OF WORK NOTES:**

1. THE SCOPE OF WORK SHEET INCLUDED ON THIS DRAWING INDICATES THE WORK THAT IS TO BE PERFORMED IN EACH UNIT. FOR FURTHER INFORMATION ON EACH WORK AREA, REFER TO THE REFERENCE NOTES FOR ADDITIONAL DETAILS ON THE WORK AREA.

Scope of Work for		Guste III Housing Development			
"M" Bldg - Unit Type "K"		Interior - Unit #401 - 4th Floor			
#	Work Item Description	Unit	Quantity	Reference Notes	Rpt #
INT 01	Remove existing outlet next to range at both sides. Install blank plate. Relocate outlet w/extended box. Place per code.	Ea	2	See Photos 4, 5 & 8 on sheet A-143. Outlets to be 36" from corner.	# 55
INT 03	Relocate Light Switch /Thermostat to be no more than 48" AFF to operating devices. Patch, finish and paint entire wall to match existing.	Ea	1	Relocate thermostat to 48" to operating buttons per sht G-003.	# 41
INT 06	Provide furr-out wall at rear of interior storage closet per detail to make depth of closet no more than 24".	LS	1	Refer Product Data Note #1 on sheet A-141 for similar details.	#48

Scope of Work for		Guste III Housing Development			
"M" Bldg - Unit Type "A"		Interior - Unit #403 - 4th Floor			
#	Work Item Description	Unit	Quantity	Reference Notes	Rpt #
INT 03	Relocate Light Switch /Thermostat to be no more than 48" AFF to operating devices. Patch, finish and paint entire wall to match existing.	Ea	1	Relocate thermostat to 48" to operating buttons per sht G-003.	# 25
INT 07	Remove existing tub & tub surround at both baths. Install blocking in wall for future grab bars. Install new tub & surround as detailed.	LS	2	Refer to Product Data Note #7 for type of tub/tub surround.	# 26

Scope of Work for		Guste III Housing Development			
"M" Bldg - Unit Type "A"		Interior - Unit #404 - 4th Floor			
#	Work Item Description	Unit	Quantity	Reference Notes	Rpt #
INT 03	Relocate Light Switch /Thermostat to be no more than 48" AFF to operating devices. Patch, finish and paint entire wall to match existing.	Ea	1	Relocate thermostat to 48" to operating buttons per sht G-003.	# 25
INT 07	Remove existing tub & tub surround at both baths. Install blocking in wall for future grab bars. Install new tub & surround as detailed.	LS	2	Refer to Product Data Note #7 for type of tub/tub surround.	# 26

Scope of Work for		Guste III Housing Development			
"M" Bldg - Unit Type "A"		Interior - Unit #406 - 4th Floor			
#	Work Item Description	Unit	Quantity	Reference Notes	Rpt #
INT 03	Relocate Light Switch /Thermostat to be no more than 48" AFF to operating devices. Patch, finish and paint entire wall to match existing.	Ea	2	Relocate thermostat to 48" to operating buttons per sht G-003.	# 25
INT 07	Remove existing tub & tub surround at both baths. Install blocking in wall for future grab bars. Install new tub & surround as detailed.	LS	2	Refer to Product Data Note #7 for type of tub/tub surround.	# 26
INT 08	Remove Toilet. Provide offset flange or reroute piping to move toilet to be 18" from centerline of toilet. Patch ceramic floor tile as required.	Ea	1	Entry Toilet at 20-1/2".	# 27

Scope of Work for		Guste III Housing Development			
"M" Bldg - Unit Type "A2"		Interior - Unit #407 - 4th Floor			
#	Work Item Description	Unit	Quantity	Reference Notes	Rpt #
INT 03	Relocate Light Switch /Thermostat to be no more than 48" AFF to operating devices. Patch, finish and paint entire wall to match existing.	Ea	1	Relocate thermostat to 48" to operating buttons per sht G-003.	# 29
INT 07	Remove existing tub & tub surround at both baths. Install blocking in wall for future grab bars. Install new tub & surround as detailed.	LS	2	Refer to Product Data Note #7 for type of tub/tub surround.	# 30

Scope of Work for		Guste III Housing Development			
"M" Bldg - Unit Type "A"		Interior - Unit #408 - 4th Floor			
#	Work Item Description	Unit	Quantity	Reference Notes	Rpt #
INT 07	Remove existing tub & tub surround at both baths. Install blocking in wall for future grab bars. Install new tub & surround as detailed.	LS	2	Refer to Product Data Note #7 for type of tub/tub surround.	# 26
INT 08	Remove Toilet. Provide offset flange or reroute piping to move toilet to be 18" from centerline of toilet. Patch ceramic floor tile as required.	Ea	1	Entry Toilet at 19".	# 27

REVISIONS	BY

ARCHITECT/ENGINEER:

**ECM Consultants, Inc.**

ENGINEERS - ARCHITECTS - CONSTRUCTION MANAGERS  
1301 CLEARVIEW PKWY. SUITE 200  
METAIRIE, LOUISIANA 70001  
PHONE: (504) 885-4080. FAX: (504) 885-1439  
EMAIL: mail@ecmconsultants.com

OWNER:

HOUSING AUTHORITY  
OF NEW ORLEANS

2051 SENATE ST. BUILDING B, RM. 202  
NEW ORLEANS, LOUISIANA 70122

PROJECT:

GUSTE III COMMUNITY  
INTERIOR & EXTERIOR REPAIRS

SHEET TITLE:  
SCOPE OF WORK SHEETS FOR  
("M" BLDG.) FOURTH FLOOR UNITS

DRAWN  
M.L.M. & A.E.D.

CHECKED  
N.G.W.

DATE  
JUN. 21, 2024

SCALE  
AS SHOWN

JOB NO.  
22462.14

SHEET NO.



**SCOPE OF WORK NOTES:**

1. THE SCOPE OF WORK SHEET INCLUDED ON THIS DRAWING INDICATES THE WORK THAT IS TO BE PERFORMED IN EACH UNIT. FOR FURTHER INFORMATION ON EACH WORK AREA, REFER TO THE REFERENCE NOTES FOR ADDITIONAL DETAILS ON THE WORK AREA.

Scope of Work for		Guste III Housing Development			
"M" Bldg - Unit Type "A"		Interior - Unit #409 - 4th Floor			
#	Work Item Description	Unit	Quantity	Reference Notes	Rpt #
INT 03	Relocate Light Switch /Thermostat to be no more than 48" AFF to operating devices. Patch, finish and paint entire wall to match existing.	Ea	1	Relocate thermostat to 48" to operating buttons per sht G-003.	# 25
INT 07	Remove existing tub & tub surround at both baths. Install blocking in wall for future grab bars. Install new tub & surround as detailed.	LS	2	Refer to Product Data Note #7 for type of tub/tub surround.	# 26

Scope of Work for		Guste III Housing Development			
"M" Bldg - Unit Type "A"		Interior - Unit #410 - 4th Floor			
#	Work Item Description	Unit	Quantity	Reference Notes	Rpt #
INT 03	Relocate Light Switch /Thermostat to be no more than 48" AFF to operating devices. Patch, finish and paint entire wall to match existing.	Ea	1	Relocate thermostat to 48" to operating buttons per sht G-003.	# 25
INT 07	Remove existing tub & tub surround at both baths. Install blocking in wall for future grab bars. Install new tub & surround as detailed.	LS	2	Refer to Product Data Note #7 for type of tub/tub surround.	# 26

Scope of Work for		Guste III Housing Development			
"M" Bldg - Unit Type "A"		Interior - Unit #411 - 4th Floor			
#	Work Item Description	Unit	Quantity	Reference Notes	Rpt #
INT 03	Relocate Light Switch /Thermostat to be no more than 48" AFF to operating devices. Patch, finish and paint entire wall to match existing.	Ea	1	Relocate thermostat to 48" to operating buttons per sht G-003.	# 25
INT 07	Remove existing tub & tub surround at both baths. Install blocking in wall for future grab bars. Install new tub & surround as detailed.	LS	2	Refer to Product Data Note #7 for type of tub/tub surround.	# 26

Scope of Work for		Guste III Housing Development			
"M" Bldg - Unit Type "C"		Interior - Unit #412 - 4th Floor			
#	Work Item Description	Unit	Quantity	Reference Notes	Rpt #
INT 01	Remove existing outlet next to range at both sides. Install blank plate. Relocate outlet w/extended box. Place per code.	Ea	2	See Photos 4, 5 & 8 on sheet A-143. Outlets to be 36" from corner.	# 55
INT 03	Relocate Light Switch /Thermostat to be no more than 48" AFF to operating devices. Patch, finish and paint entire wall to match existing.	Ea	1	Relocate thermostat to 48" to operating buttons per sht G-003.	# 34
INT 07	Remove existing tub & tub surround at both baths. Install blocking in wall for future grab bars. Install new tub & surround as detailed.	LS	2	Refer to Product Data Note #7 for type of tub/tub surround.	# 35

Scope of Work for		Guste III Housing Development			
"M" Bldg - Unit Type "B"		Interior - Unit #413 - 4th Floor			
#	Work Item Description	Unit	Quantity	Reference Notes	Rpt #
INT 01	Remove existing outlet next to range at both sides. Install blank plate. Relocate outlet w/extended box. Place per code.	Ea	2	See Photos 4, 5 & 8 on sheet A-142. Outlets to be 36" from corner.	# 55
INT 03	Relocate Light Switch /Thermostat to be no more than 48" AFF to operating devices. Patch, finish and paint entire wall to match existing.	Ea	1	Relocate thermostat to 48" to operating buttons per sht G-003.	# 31
INT 11	Lower elec panelboard to make top most operable is at 48" AFF.	LS	1	See Report #31a.	# 31a
INT 13	Remove braces under Lav Counter. Modify brace at wall for knee clearance. Reinstall open end brace to be 30" clear.	LS	1		# 31c
INT 15	Remove to reinstall toilet tissue holder. Per code. Patch wall and paint.	EA	1	See sheet G-003 for toilet tissue requirements.	# 31e & f
INT 16	Remove to reinstall shower controls and piping to meet code. Patch existing tub surround as req'd.	EA	1	See Report #31g for direction.	# 31g

REVISIONS	BY

**ECM Consultants, Inc.**  
 ARCHITECT/ENGINEER:  
 ENGINEERS - ARCHITECTS - CONSTRUCTION MANAGERS  
 1301 CLEARVIEW PKWY. SUITE 200  
 METAIRIE, LOUISIANA 70001  
 PHONE: (504) 885-4080, FAX: (504) 885-1439  
 EMAIL: mail@ecmconsultants.com

OWNER:  
 HOUSING AUTHORITY  
 OF NEW ORLEANS  
 2051 SENATE ST. BUILDING B, RM. 202  
 NEW ORLEANS, LOUISIANA 70122

PROJECT:  
 GUSTE III COMMUNITY  
 INTERIOR & EXTERIOR REPAIRS  
 SHEET TITLE:  
 SCOPE OF WORK SHEETS FOR  
 ("M" BLDG.) FOURTH FLOOR UNITS

DRAWN  
 M.L.M. & A.E.D.  
 CHECKED  
 N.G.W.  
 DATE  
 JUN. 21, 2024  
 SCALE  
 AS SHOWN  
 JOB NO.  
 22462.14  
 SHEET NO.

**SCOPE OF WORK NOTES:**

1. THE SCOPE OF WORK SHEET INCLUDED ON THIS DRAWING INDICATES THE WORK THAT IS TO BE PERFORMED IN EACH UNIT. FOR FURTHER INFORMATION ON EACH WORK AREA, REFER TO THE REFERENCE NOTES FOR ADDITIONAL DETAILS ON THE WORK AREA.
2. REFER TO SHEET A-116 FOR PLAN OF "G" UNITS.

Scope of Work for		Guste III Housing Development			
"G" Bldg - Unit / Work Type		Interior - 1210 Rev John Raphael Jr Way			
#	Work Item Description	Unit	Quantity	Reference Notes	Rpt #
INT 01	Remove existing outlet next to range at both sides. Install blank plate. Relocate outlet w/extended box. Place per code.	Ea	2	See Photos 4, 5 & 8 on sheet A-143. Outlets to be 36" from corner.	# 55
INT 04	Provide code compliant beveled threshold to meet code at interior side of door.	Ea	1	Refer to Product Data Note #3 for type of threshold.	# 51
INT 05	Provide furr-out wall at rear of exterior storage closet. Add Fire-rated gyp board to under side of stairs per detail.	LS	1	Refer Product Data Note #1, A & B on sheet A-141 for details	# 52
INT 06	Provide furr-out wall at rear of interior storage closet per detail to make depth of closet no more than 24".	LS	1	Refer Product Data Note #1 on sheet A-141 for similar details.	# 53
INT 07	Remove existing tub & tub surround at both baths. Install blocking in wall for future grab bars. Install new tub & surround as detailed.	LS	2	Refer to Product Data Notes #7 for type of tub/tub surround.	# 57

Scope of Work for		Guste III Housing Development			
"G" Bldg - Unit / Work Type		Interior - 1217 S. Liberty Street			
#	Work Item Description	Unit	Quantity	Reference Notes	Rpt #
INT 01	Remove existing outlet next to range at both sides. Install blank plate. Relocate outlet w/extended box. Place per code.	Ea	2	See Photos 4, 5 & 8 on sheet A-143. Outlets to be 36" from corner.	# 64
INT 03	Relocate Light Switch /Thermostat to be no more than 48" AFF to operating devices. Patch, finish and paint entire wall to match existing.	Ea	2	Relocate light switch at Entry & Kit / Hall to 48" to operating swithes	# 65
INT 04	Provide code compliant beveled threshold to meet code at interior side of door.	Ea	1	Refer to Product Data Note #3 for type of threshold.	# 51
INT 05	Provide furr-out wall at rear of exterior storage closet. Add Fire-rated gyp board to under side of stairs per detail.	LS	1	Refer Product Data Note #1, A & B on sheet A-141 for details	# 52
INT 06	Provide furr-out wall at rear of interior storage closet per detail to make depth of closet no more than 24".	LS	1	Refer Product Data Note #1 on sheet A-141 for similar details.	# 63
INT 07	Remove existing tub & tub surround at both baths. Install blocking in wall for future grab bars. Install new tub & surround as detailed.	LS	2	Refer to Product Data Notes #7 for type of tub/tub surround.	# 57

Scope of Work for		Guste III Housing Development			
"G" Bldg - Unit / Work Type		Interior - 1212 Rev John Raphael Jr Way			
#	Work Item Description	Unit	Quantity	Reference Notes	Rpt #
INT 01	Remove existing outlet next to range at both sides. Install blank plate. Relocate outlet w/extended box. Place per code.	Ea	2	See Photos 4, 5 & 8 on sheet A-143. Outlets to be 36" from corner.	# 55
INT 04	Provide code compliant beveled threshold to meet code at interior side of door.	Ea	1	Refer to Product Data Note #3 for type of threshold.	# 51
INT 05	Provide furr-out wall at rear of exterior storage closet. Add Fire-rated gyp board to under side of stairs per detail.	LS	1	Refer Product Data Note #1, A & B on sheet A-141 for details	# 52
INT 06	Provide furr-out wall at rear of interior storage closet per detail to make depth of closet no more than 24".	LS	1	Refer Product Data Note #1 on sheet A-141 for similar details.	# 53
INT 07	Remove existing tub & tub surround at both baths. Install blocking in wall for future grab bars. Install new tub & surround as detailed.	LS	2	Refer to Product Data Notes #7 for type of tub/tub surround.	# 57

Scope of Work for		Guste III Housing Development			
"G" Bldg - Unit / Work Type		Interior - 2410 Erato Street			
#	Work Item Description	Unit	Quantity	Reference Notes	Rpt #
INT 01	Remove existing outlet next to range at both sides. Install blank plate. Relocate outlet w/extended box. Place per code.	Ea	2	See Photos 4, 5 & 8 on sheet A-143. Outlets to be 36" from corner.	# 55
INT 04	Provide code compliant beveled threshold to meet code at interior side of door.	Ea	1	Refer to Product Data Note #3 for type of threshold.	# 51
INT 05	Provide furr-out wall at rear of exterior storage closet. Add Fire-rated gyp board to under side of stairs per detail.	LS	1	Refer Product Data Note #1, A & B on sheet A-141 for details	# 52
INT 06	Provide furr-out wall at rear of interior storage closet per detail to make depth of closet no more than 24".	LS	1	Refer Product Data Note #1 on sheet A-141 for similar details.	# 53
INT 07	Remove existing tub & tub surround at both baths. Install blocking in wall for future grab bars. Install new tub & surround as detailed.	LS	2	Refer to Product Data Notes #7 for type of tub/tub surround.	# 57

Scope of Work for		Guste III Housing Development			
"G" Bldg - Unit / Work Type		Interior - 2306 Erato Street			
#	Work Item Description	Unit	Quantity	Reference Notes	Rpt #
INT 01	Remove existing outlet next to range at both sides. Install blank plate. Relocate outlet w/extended box. Place per code.	Ea	2	See Photos 4, 5 & 8 on sheet A-143. Outlets to be 36" from corner.	# 64
INT 03	Relocate Light Switch /Thermostat to be no more than 48" AFF to operating devices. Patch, finish and paint entire wall to match existing.	Ea	2	Relocate light switch at Entry & Kit / Hall to 48" to operating swithes	# 65
INT 04	Provide code compliant beveled threshold at inside of entry door to meet code.	Ea	1	Refer to Product Data Note #3 for type of threshold.	# 51
INT 05	Provide furr-out wall at rear of exterior storage closet. Add Fire-rated gyp board to under side of stairs per detail.	LS	1	Refer Product Data Note #1, A & B on sheet A-141 for details	# 52
INT 06	Provide furr-out wall at rear of interior storage closet per detail to make depth of closet no more than 24".	LS	1	Refer Product Data Note #1 on sheet A-141 for similar details.	# 63
INT 07	Remove existing tub & tub surround at both baths. Install blocking in wall for future grab bars. Install new tub & surround as detailed.	LS	2	Refer to Product Data Notes #7 for type of tub/tub surround.	# 57

Scope of Work for		Guste III Housing Development			
"G" Bldg - Unit / Work Type		Interior - 1217 Rev John Raphael Jr Way			
#	Work Item Description	Unit	Quantity	Reference Notes	Rpt #
INT 01	Remove existing outlet next to range at both sides. Install blank plate. Relocate outlet w/extended box. Place per code.	Ea	2	See Photos 4, 5 & 8 on sheet A-143. Outlets to be 36" from corner.	# 55
INT 04	Provide code compliant beveled threshold to meet code at interior side of door.	Ea	1	Refer to Product Data Note #3 for type of threshold.	# 51
INT 05	Provide furr-out wall at rear of exterior storage closet. Add Fire-rated gyp board to under side of stairs per detail.	LS	1	Refer Product Data Note #1, A & B on sheet A-141 for details	# 52
INT 06	Provide furr-out wall at rear of interior storage closet per detail to make depth of closet no more than 24".	LS	1	Refer Product Data Note #1 on sheet A-141 for similar details.	# 53
INT 07	Remove existing tub & tub surround at both baths. Install blocking in wall for future grab bars. Install new tub & surround as detailed.	LS	2	Refer to Product Data Notes #7 for type of tub/tub surround.	# 57
INT 08	Remove Toilet. Chip out slab to move toilet per offset flange to be 18" from centerline of toilet. Patch ceramic floor tile as required.	Ea	1	Bed Toilet at 14-1/2".	# 58

Scope of Work for		Guste III Housing Development			
"G" Bldg - Unit / Work Type		Interior - 2412 Erato Street			
#	Work Item Description	Unit	Quantity	Reference Notes	Rpt #
INT 01	Remove existing outlet next to range at both sides. Install blank plate. Relocate outlet w/extended box. Place per code.	Ea	2	See Photos 4, 5 & 8 on sheet A-143. Outlets to be 36" from corner.	# 55
INT 03	Relocate Light Switch /Thermostat to be no more than 48" AFF to operating devices. Patch, finish and paint entire wall to match existing.	Ea	1	Relocate light switch at Bed2 to 48" to lever per sht G-003.	# 54
INT 04	Provide code compliant beveled threshold to meet code at interior side of door.	Ea	1	Refer to Product Data Note #3 for type of threshold.	# 51
INT 05	Provide furr-out wall at rear of exterior storage closet. Add Fire-rated gyp board to under side of stairs per detail.	LS	1	Refer Product Data Note #1, A & B on sheet A-141 for details	# 52
INT 06	Provide furr-out wall at rear of interior storage closet per detail to make depth of closet no more than 24".	LS	1	Refer Product Data Note #1 on sheet A-141 for similar details.	# 53
INT 07	Remove existing tub & tub surround at both baths. Install blocking in wall for future grab bars. Install new tub & surround as detailed.	LS	2	Refer to Product Data Notes #7 for type of tub/tub surround.	# 57

REVISIONS	BY

**ECM Consultants, Inc.**  
 ARCHITECT/ENGINEER  
 ENGINEERS - ARCHITECTS - CONSTRUCTION MANAGERS  
 1301 CLEARVIEW PKWY. SUITE 200  
 METAIRIE, LOUISIANA 70001  
 PHONE: (504) 885-4080. FAX: (504) 885-1439  
 EMAIL: mail@ecmconsultants.com

HOUSING AUTHORITY  
 OF NEW ORLEANS  
 2051 SENATE ST. BUILDING B, RM. 202  
 NEW ORLEANS, LOUISIANA 70122

PROJECT:  
 GUSTE III COMMUNITY  
 INTERIOR & EXTERIOR REPAIRS  
 SHEET TITLE:  
 SCOPE OF WORK SHEETS FOR  
 G UNITS AT GUSTE III

DRAWN  
 M.L.M. & A.E.D.  
 CHECKED  
 N.G.W.  
 DATE  
 JUN. 21, 2024  
 SCALE  
 AS SHOWN  
 JOB NO.  
 22462.14  
 SHEET NO.

**SCOPE OF WORK NOTES:**

1. THE SCOPE OF WORK SHEET INCLUDED ON THIS DRAWING INDICATES THE WORK THAT IS TO BE PERFORMED IN EACH UNIT. FOR FURTHER INFORMATION ON EACH WORK AREA, REFER TO THE REFERENCE NOTES FOR ADDITIONAL DETAILS ON THE WORK AREA.
2. REFER TO SHEET A-117 FOR PLAN OF "G1" UNITS.

Scope of Work for		Guste III Housing Development			
"G-1" Bldg - Unit / Work Type		Interior - 1215 S. Liberty Street			
#	Work Item Description	Unit	Quantity	Reference Notes	Rpt #
INT 01	Remove existing outlet next to range at both sides. Install blank plate. Relocate outlet w/extended box. Place per code.	Ea	2	See Photos 4, 5 & 8 on sheet A-143. Outlets to be 36" from corner.	# 64
INT 03	Relocate Light Switch /Thermostat to be no more than 48" AFF to operating devices. Patch, finish and paint entire wall to match existing.	Ea	1	Relocate light switch at kit/hall to 48" to lever per sht G-003.	# 65
INT 04	Provide code compliant beveled threshold to meet code at interior side of door.	Ea	1	Refer to Product Data Note #3 for type of threshold.	# 51
INT 05	Provide furr-out wall at rear of exterior storage closet. Add Fire-rated gyp board to under side of stairs per detail.	LS	1	Refer Product Data Note #1, A & B on sheet A-141 for details	# 52
INT 06	Provide furr-out wall at rear of interior storage closet per detail to make depth of closet no more than 24".	LS	1	Refer Product Data Note #1 on sheet A-141 for similar details.	# 63
INT 07	Remove existing tub & tub surround at both baths. Install blocking in wall for future grab bars. Install new tub & surround as detailed.	LS	2	Refer to Product Data Notes #7 for type of tub/tub surround.	# 57
INT 08	Remove Toilet. Chip out slab to move toilet per offset flange to be 18" from centerline of toilet. Patch ceramic floor tile as required.	Ea	1	Hall Toilet at 13-1/2" to side wall.	# 58

Scope of Work for		Guste III Housing Development			
"G-1" Bldg - Unit / Work Type		Interior - 2308 Erato Street			
#	Work Item Description	Unit	Quantity	Reference Notes	Rpt #
INT 01	Remove existing outlet next to range at both sides. Install blank plate. Relocate outlet w/extended box. Place per code.	Ea	2	See Photos 4, 5 & 8 on sheet A-143. Outlets to be 36" from corner.	# 64
INT 03	Relocate Light Switch /Thermostat to be no more than 48" AFF to operating devices. Patch, finish and paint entire wall to match existing.	Ea	1	Relocate light switch at Bed 2 to 48" to operating swithes	# 65
INT 04	Provide code compliant beveled threshold to meet code at interior side of door.	Ea	1	Refer to Product Data Note #3 for type of threshold.	# 51
INT 05	Provide furr-out wall at rear of exterior storage closet. Add Fire-rated gyp board to under side of stairs per detail.	LS	1	Refer Product Data Note #1, A & B on sheet A-141 for details	# 52
INT 06	Provide furr-out wall at rear of interior storage closet per detail to make depth of closet no more than 24".	LS	1	Refer Product Data Note #1 on sheet A-141 for similar details.	# 63
INT 07	Remove existing tub & tub surround at both baths. Install blocking in wall for future grab bars. Install new tub & surround as detailed.	LS	2	Refer to Product Data Notes #7 for type of tub/tub surround.	# 57
INT 08	Remove Toilet. Chip out slab to move toilet per offset flange to be 18" from centerline of toilet. Patch ceramic floor tile as required.	Ea	2	Hall Toilet at 14" to side wall. Bed Toilet at 19".	# 58

Scope of Work for		Guste III Housing Development			
"G-1" Bldg - Unit / Work Type		Interior - 1215 Rev John Raphael Jr Way			
#	Work Item Description	Unit	Quantity	Reference Notes	Rpt #
INT 01	Remove existing outlet next to range at both sides. Install blank plate. Relocate outlet w/extended box. Place per code.	Ea	2	See Photos 4, 5 & 8 on sheet A-143. Outlets to be 36" from corner.	# 55
INT 04	Provide code compliant beveled threshold to meet code at interior side of door.	Ea	1	Refer to Product Data Note #3 for type of threshold.	# 51
INT 05	Provide furr-out wall at rear of exterior storage closet. Add Fire-rated gyp board to under side of stairs per detail.	LS	1	Refer Product Data Note #1, A & B on sheet A-141 for details	# 52
INT 06	Provide furr-out wall at rear of interior storage closet per detail to make depth of closet no more than 24".	LS	1	Refer Product Data Note #1 on sheet A-141 for similar details.	# 53
INT 07	Remove existing tub & tub surround at entry bath. Install blocking in wall for future grab bars. Install new tub & surround as detailed.	LS	1	Refer to Product Data Notes #7 for type of tub/tub surround.	# 57
INT 08	Remove Toilet. Chip out slab to move toilet per offset flange to be 18" from centerline of toilet. Patch ceramic floor tile as required.	Ea	1	Hall Toilet at 13" to side wall.	# 58

REVISIONS	BY

**ECM Consultants, Inc.**  
 ARCHITECT/ENGINEER:  
 ENGINEERS - ARCHITECTS - CONSTRUCTION MANAGERS  
 1301 CLEARVIEW PKWY. SUITE 200  
 METAIRIE, LOUISIANA 70001  
 PHONE: (504) 885-4080. FAX: (504) 885-1439  
 EMAIL: mail@ecmconsultants.com

OWNER:  
**HOUSING AUTHORITY OF NEW ORLEANS**  
 2051 SENATE ST. BUILDING B, RM. 202  
 NEW ORLEANS, LOUISIANA 70122

PROJECT:  
**GUSTE III COMMUNITY INTERIOR & EXTERIOR REPAIRS**  
 SHEET TITLE:  
**SCOPE OF WORK SHEETS FOR G1 UNITS AT GUSTE III**

DRAWN
M.L.M. & A.E.D.
CHECKED
N.G.W.
DATE
JUN. 21, 2024
SCALE
AS SHOWN
JOB NO.
22462.14
SHEET NO.

**SCOPE OF WORK NOTES:**

1. THE SCOPE OF WORK SHEET INCLUDED ON THIS DRAWING INDICATES THE WORK THAT IS TO BE PERFORMED IN EACH UNIT. FOR FURTHER INFORMATION ON EACH WORK AREA, REFER TO THE REFERENCE NOTES FOR ADDITIONAL DETAILS ON THE WORK AREA.
2. REFER TO SHEET A-118 FOR PLAN OF "H" UNITS.

Scope of Work for		Guste III Housing Development			
"H" Bldg - Unit / Work Type		Interior - 1202 Freret Street			
#	Work Item Description	Unit	Quantity	Reference Notes	Rpt #
INT 01	Remove existing outlet next to range at both sides. Install blank plate. Relocate outlet w/extended box. Place per code.	Ea	2	See Photos 4, 5 & 8 on sheet A-143. Outlets to be 36" from corner.	# 55
INT 03	Relocate Light Switch /Thermostat to be no more than 48" AFF to operating devices. Patch, finish and paint entire wall to match existing.	Ea	1	Relocate Thermostat to 48" to lever per sht G-003.	# 54
INT 04	Provide code compliant beveled threshold to meet code at interior side of door.	Ea	1	Refer to Product Data Note #3 for type of threshold.	# 51
INT 05	Provide furr-out wall at rear of exterior storage closet. Add Fire-rated gyp board to under side of stairs per detail.	LS	1	Refer Product Data Note #1, A & B on sheet A-141 for details	# 52
INT 06	Provide furr-out wall at rear of interior storage closet per detail to make depth of closet no more than 24".	LS	1	Refer Product Data Note #1 on sheet A-141 for similar details.	# 53
INT 07	Remove existing tub & tub surround at both baths. Install blocking in wall for future grab bars. Install new tub & surround as detailed.	LS	2	Refer to Product Data Notes #7 for type of tub/tub surround.	# 57
INT 08	Remove Toilet. Chip out slab to move toilet per offset flange to be 18" from centerline of toilet. Patch ceramic floor tile as required.	Ea	1	Bed Toilet at 14".	# 58

Scope of Work for		Guste III Housing Development			
"H" Bldg - Unit / Work Type		Interior - 1224 Rev John Raphael Jr Way			
#	Work Item Description	Unit	Quantity	Reference Notes	Rpt #
INT 01	Remove existing outlet next to range at both sides. Install blank plate. Relocate outlet w/extended box. Place per code.	Ea	2	See Photos 4, 5 & 8 on sheet A-143. Outlets to be 36" from corner.	# 55
INT 03	Relocate Light Switch /Thermostat to be no more than 48" AFF to operating devices. Patch, finish and paint entire wall to match existing.	Ea	1	Relocate Entry switch to 48" to lever per sht G-003.	# 54
INT 04	Provide code compliant beveled threshold to meet code at interior side of door.	Ea	1	Refer to Product Data Note #3 for type of threshold.	# 51
INT 05	Provide furr-out wall at rear of exterior storage closet. Add Fire-rated gyp board to under side of stairs per detail.	LS	1	Refer Product Data Note #1, A & B on sheet A-141 for details	# 52
INT 06	Provide furr-out wall at rear of interior storage closet per detail to make depth of closet no more than 24".	LS	1	Refer Product Data Note #1 on sheet A-141 for similar details.	# 53
INT 07	Remove existing tub & tub surround at both baths. Install blocking in wall for future grab bars. Install new tub & surround as detailed.	LS	2	Refer to Product Data Notes #7 for type of tub/tub surround.	# 57

Scope of Work for		Guste III Housing Development			
"H" Bldg - Unit / Work Type		Interior - 1204 Freret Street			
#	Work Item Description	Unit	Quantity	Reference Notes	Rpt #
INT 01	Remove existing outlet next to range at both sides. Install blank plate. Relocate outlet w/extended box. Place per code.	Ea	2	See Photos 4, 5 & 8 on sheet A-143. Outlets to be 36" from corner.	# 55
INT 04	Provide code compliant beveled threshold to meet code at interior side of door.	Ea	1	Refer to Product Data Note #3 for type of threshold.	# 51
INT 05	Provide furr-out wall at rear of exterior storage closet. Add Fire-rated gyp board to under side of stairs per detail.	LS	1	Refer Product Data Note #1, A & B on sheet A-141 for details	# 52
INT 06	Provide furr-out wall at rear of interior storage closet per detail to make depth of closet no more than 24".	LS	1	Refer Product Data Note #1 on sheet A-141 for similar details.	# 53
INT 07	Remove existing tub & tub surround at both baths. Install blocking in wall for future grab bars. Install new tub & surround as detailed.	LS	2	Refer to Product Data Notes #7 for type of tub/tub surround.	# 57

Scope of Work for		Guste III Housing Development			
"H" Bldg - Unit / Work Type		Interior - 2322 Erato Street			
#	Work Item Description	Unit	Quantity	Reference Notes	Rpt #
INT 01	Remove existing outlet next to range at both sides. Install blank plate. Relocate outlet w/extended box. Place per code.	Ea	2	See Photos 4, 5 & 8 on sheet A-143. Outlets to be 36" from corner.	# 55
INT 03	Relocate Light Switch /Thermostat to be no more than 48" AFF to operating devices. Patch, finish and paint entire wall to match existing.	Ea	1	Relocate Thermostat to 48" to lever per sht G-003.	# 54
INT 04	Provide code compliant beveled threshold to meet code at interior side of door.	Ea	1	Refer to Product Data Note #3 for type of threshold.	# 51
INT 05	Provide furr-out wall at rear of exterior storage closet. Add Fire-rated gyp board to under side of stairs per detail.	LS	1	Refer Product Data Note #1, A & B on sheet A-141 for details	# 52
INT 06	Provide furr-out wall at rear of interior storage closet per detail to make depth of closet no more than 24".	LS	1	Refer Product Data Note #1 on sheet A-141 for similar details.	# 53
INT 07	Remove existing tub & tub surround at both baths. Install blocking in wall for future grab bars. Install new tub & surround as detailed.	LS	2	Refer to Product Data Notes #7 for type of tub/tub surround.	# 57

Scope of Work for		Guste III Housing Development			
"H" Bldg - Unit / Work Type		Interior - 1222 Rev John Raphael Jr Way			
#	Work Item Description	Unit	Quantity	Reference Notes	Rpt #
INT 01	Remove existing outlet next to range at both sides. Install blank plate. Relocate outlet w/extended box. Place per code.	Ea	2	See Photos 4, 5 & 8 on sheet A-143. Outlets to be 36" from corner.	# 55
INT 04	Provide code compliant beveled threshold to meet code at interior side of door.	Ea	1	Refer to Product Data Note #3 for type of threshold.	# 51
INT 05	Provide furr-out wall at rear of exterior storage closet. Add Fire-rated gyp board to under side of stairs per detail.	LS	1	Refer Product Data Note #1, A & B on sheet A-141 for details	# 52
INT 06	Provide furr-out wall at rear of interior storage closet per detail to make depth of closet no more than 24".	LS	1	Refer Product Data Note #1 on sheet A-141 for similar details.	# 53
INT 07	Remove existing tub & tub surround at both baths. Install blocking in wall for future grab bars. Install new tub & surround as detailed.	LS	2	Refer to Product Data Notes #7 for type of tub/tub surround.	# 57

Scope of Work for		Guste III Housing Development			
"H" Bldg - Unit / Work Type		Interior - 2324 Erato Street			
#	Work Item Description	Unit	Quantity	Reference Notes	Rpt #
INT 01	Remove existing outlet next to range at both sides. Install blank plate. Relocate outlet w/extended box. Place per code.	Ea	2	See Photos 4, 5 & 8 on sheet A-143. Outlets to be 36" from corner.	# 55
INT 03	Relocate Light Switch /Thermostat to be no more than 48" AFF to operating devices. Patch, finish and paint entire wall to match existing.	Ea	2	Relocate Thermostat & Entry Switch to 48" to operating parts.	# 54
INT 04	Provide code compliant beveled threshold to meet code at interior side of door.	Ea	1	Refer to Product Data Note #3 for type of threshold.	# 51
INT 05	Provide furr-out wall at rear of exterior storage closet. Add Fire-rated gyp board to under side of stairs per detail.	LS	1	Refer Product Data Note #1, A & B on sheet A-141 for details	# 52
INT 06	Provide furr-out wall at rear of interior storage closet per detail to make depth of closet no more than 24".	LS	1	Refer Product Data Note #1 on sheet A-141 for similar details.	# 53
INT 07	Remove existing tub & tub surround at both baths. Install blocking in wall for future grab bars. Install new tub & surround as detailed.	LS	2	Refer to Product Data Notes #7 for type of tub/tub surround.	# 57

REVISIONS	BY

**ECM Consultants, Inc.**  
 ARCHITECT/ENGINEER  
 ENGINEERS - ARCHITECTS - CONSTRUCTION MANAGERS  
 1301 CLEARVIEW PKWY. SUITE 200  
 METAIRIE, LOUISIANA 70001  
 PHONE: (504) 885-4080. FAX: (504) 885-1439  
 EMAIL: mail@ecmconsultants.com

HOUSING AUTHORITY  
 OF NEW ORLEANS  
 2051 SENATE ST. BUILDING B, RM. 202  
 NEW ORLEANS, LOUISIANA 70122

PROJECT:  
 GUSTE III COMMUNITY  
 INTERIOR & EXTERIOR REPAIRS  
 SHEET TITLE:  
 SCOPE OF WORK SHEETS FOR  
 H UNITS AT GUSTE III

DRAWN  
 M.L.M. & A.E.D.  
 CHECKED  
 N.G.W.  
 DATE  
 JUN. 21, 2024  
 SCALE  
 AS SHOWN  
 JOB NO.  
 22462.14  
 SHEET NO.

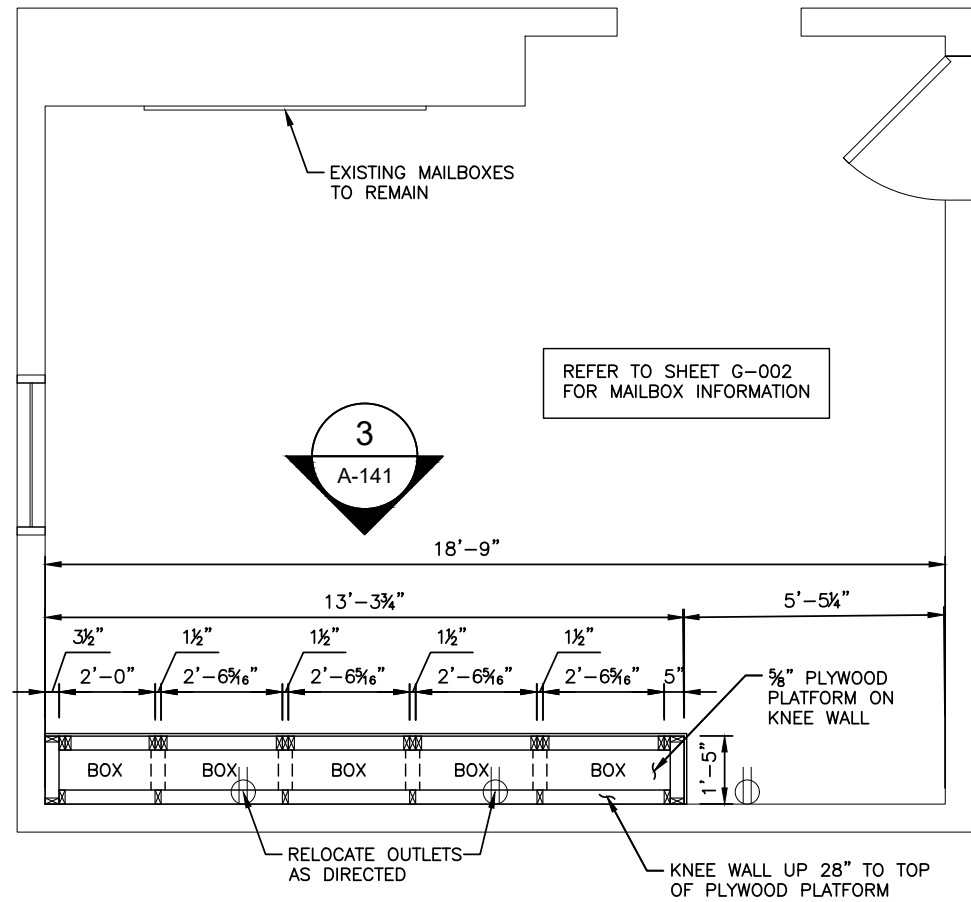

**2** PLAN - MAILBOXES  
A-141 MAILROOM

SCALE: 1/2" = 1'-0"

NOTE: ALL ABANDONED BOXES TO RECEIVE BLANK COVERS.

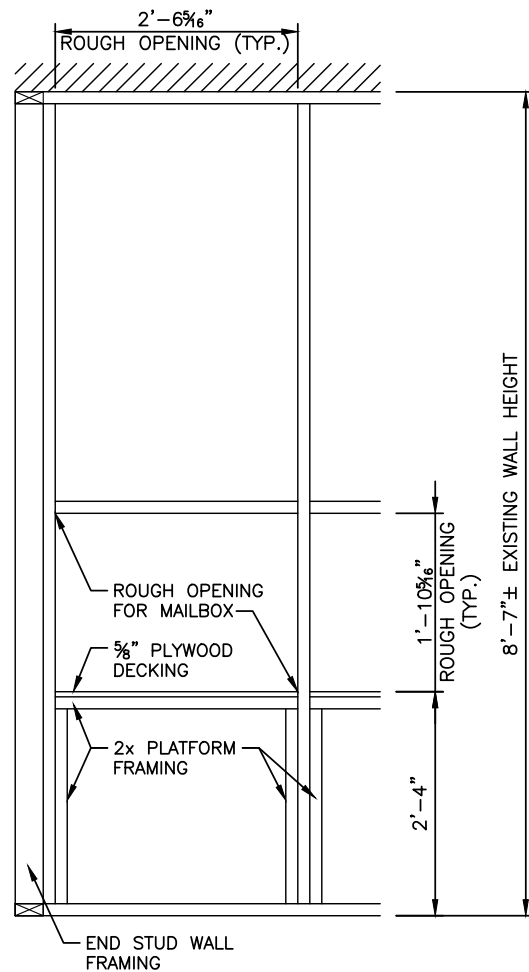

**3** ELEVATION  
A-141 MAILROOM

SCALE: 1" = 1'-0"

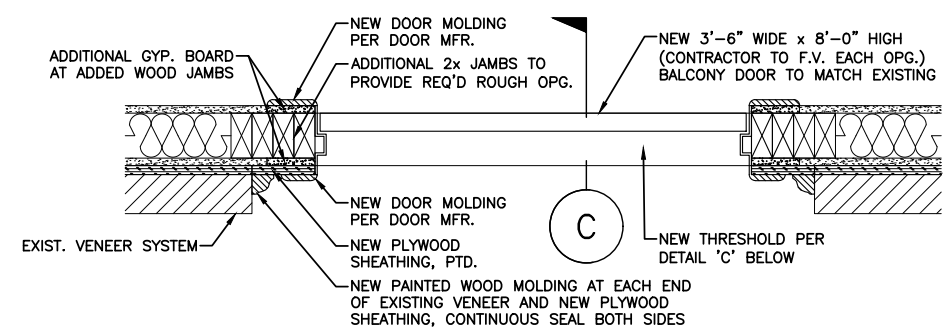

**4** PLAN @ NEW DOOR OPENING  
A-141 BALCONY DOOR

SCALE: 1-1/2" = 1'-0"

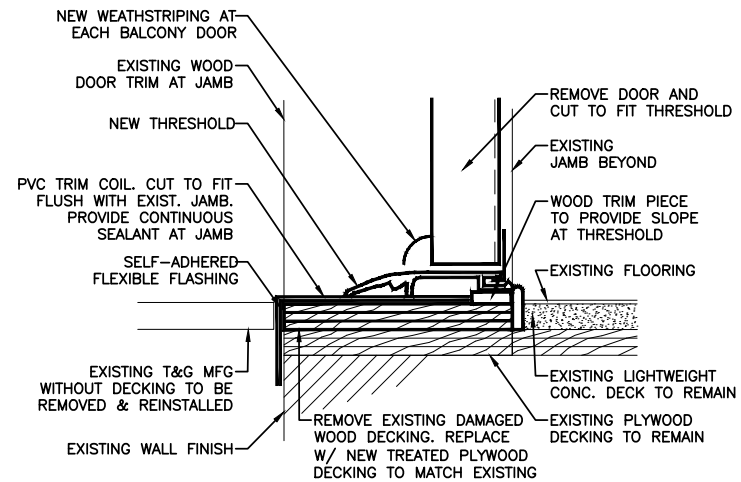

**C** THRESHOLD DETAIL  
A-141 BALCONY DOOR

N.T.S.

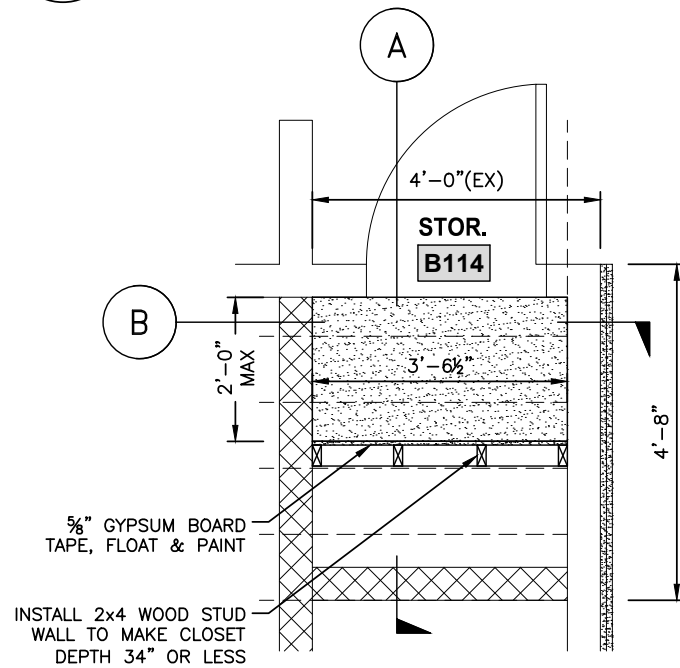

**1** PLAN - FURR OUT WALL  
A-141 STORAGE CLOSET

SCALE: 3/4" = 1'-0"

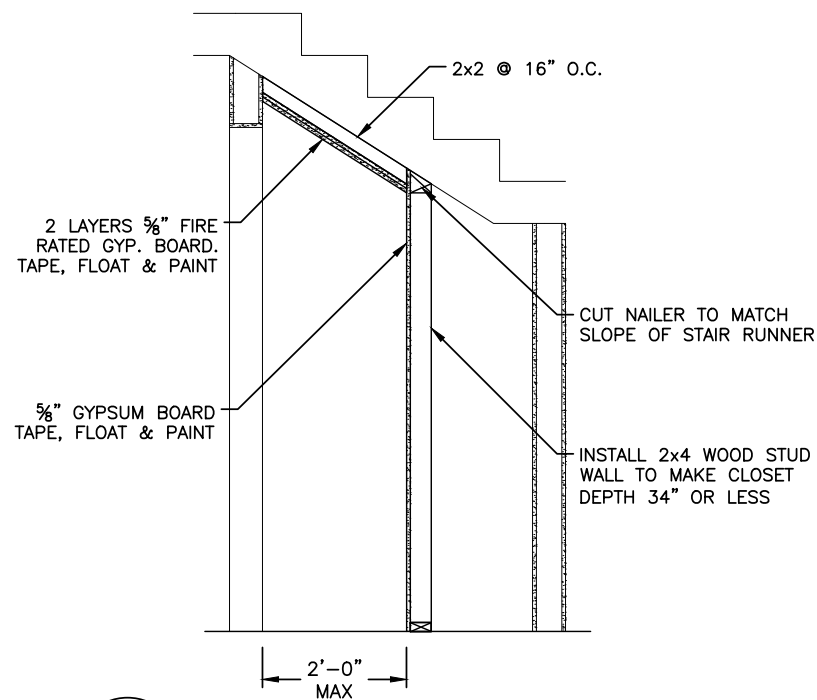

**A** SECTION THRU CLOSET  
A-141 STORAGE CLOSET

SCALE: 3/4" = 1'-0"

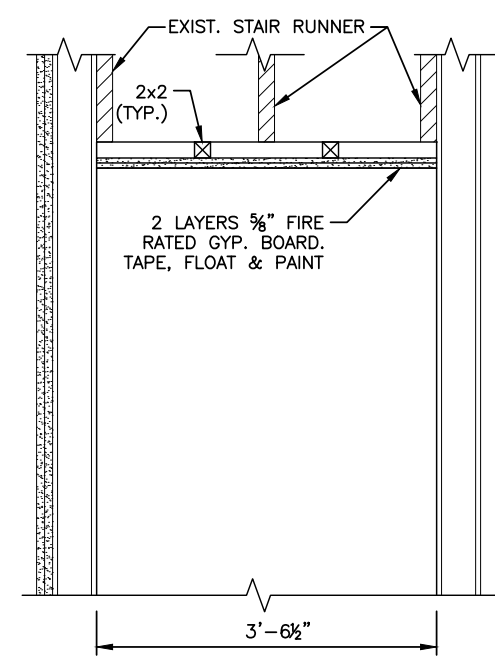

**B** SECTION THRU CEILING  
A-141 STORAGE CLOSET

SCALE: 1" = 1'-0"

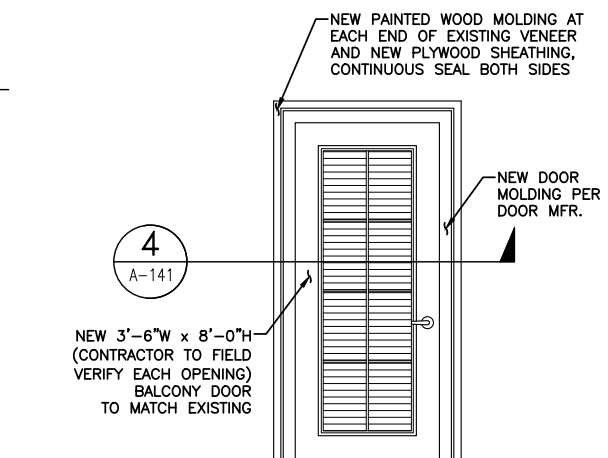

**5** DOOR ELEVATION  
A-141 BALCONY DOOR

SCALE: 1-1/2" = 1'-0"

REVISIONS	BY

**ECM Consultants, Inc.**  
ARCHITECT/ENGINEER  
ENGINEERS - ARCHITECTS - CONSTRUCTION MANAGERS  
1301 CLEARVIEW PKWY. SUITE 200  
METAIRIE, LOUISIANA 70001  
PHONE: (504) 885-4080, FAX: (504) 885-1439  
EMAIL: mail@ecmconsultants.com

OWNER:  
HOUSING AUTHORITY  
OF NEW ORLEANS  
2051 SENATE ST. BUILDING B, RM. 202  
NEW ORLEANS, LOUISIANA 70122

PROJECT:  
GUSTE III COMMUNITY  
INTERIOR & EXTERIOR REPAIRS  
SHEET TITLE:  
MISCELLANEOUS DETAILS

DRAWN	M.L.M. & A.E.D.
CHECKED	N.G.W.
DATE	JUN. 21, 2024
SCALE	AS SHOWN
JOB NO.	22462.14
SHEET NO.	A-141

A-141



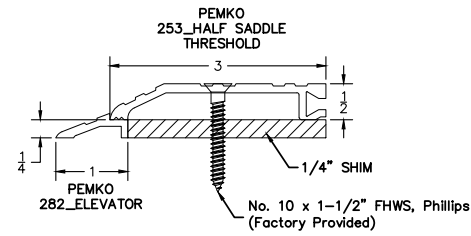

1  
A-142 **3/4" THRESHOLD DETAIL**  
@ ENTRANCE DOORS SCALE: 9" = 1'-0"

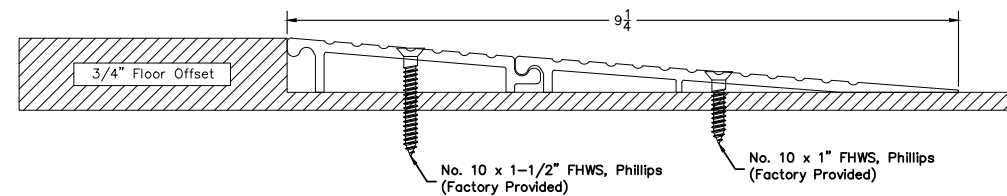

PEMKO R.75F\_ FLUSH THRESHOLD ASSEMBLY  
R.75FA: A - MILL FINISH ALUMINUM ALUMINUM  
R.75FAK: AK - PEMKOTE SKID RESISTANT SURFACING ALUMINUM

2  
A-142 **3/4" THRESHOLD DETAIL**  
@ INTERIOR DOORS SCALE: 9" = 1'-0"

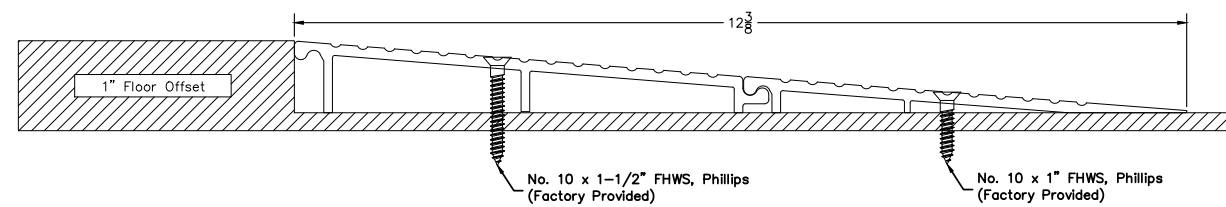

PEMKO R1F\_ FLUSH THRESHOLD ASSEMBLY  
R1FA: A - MILL FINISH ALUMINUM ALUMINUM  
R1FAK: AK - PEMKOTE SKID RESISTANT SURFACING ALUMINUM

3  
A-142 **1" THRESHOLD DETAIL**  
@ INTERIOR DOORS SCALE: 9" = 1'-0"

NOTE: MAXIMUM 1/2" HEIGHT ALLOWED AT COMMON AREAS AND 3/4" HEIGHT AT TYPE B UNITS.

REVISIONS	BY

ARCHITECT/ENGINEER:  
**ECM Consultants, Inc.**  
ENGINEERS - ARCHITECTS - CONSTRUCTION MANAGERS  
1301 CLEARVIEW PKWY. SUITE 200  
METAIRIE, LOUISIANA 70001  
PHONE: (504) 885-4080, FAX: (504) 885-1439  
EMAIL: mail@ecmconsultants.com

OWNER:  
HOUSING AUTHORITY  
OF NEW ORLEANS  
2051 SENATE ST. BUILDING B, RM. 202  
NEW ORLEANS, LOUISIANA 70122

PROJECT:  
GUSTE III COMMUNITY  
INTERIOR & EXTERIOR REPAIRS  
SHEET TITLE:  
MISCELLANEOUS DETAILS

DRAWN
M.L.M. & A.E.D.
CHECKED
N.G.W.
DATE
JUN. 21, 2024
SCALE
AS SHOWN
JOB NO.
22462.14
SHEET NO.

A-142

REVISIONS	BY

REMOVE TUB AND SURROUND FOR INSTALLATION OF WOOD BLOCKING WHERE INDICATED. INSTALL NEW TUB & SURROUND PER PRODUCT NOTE #7

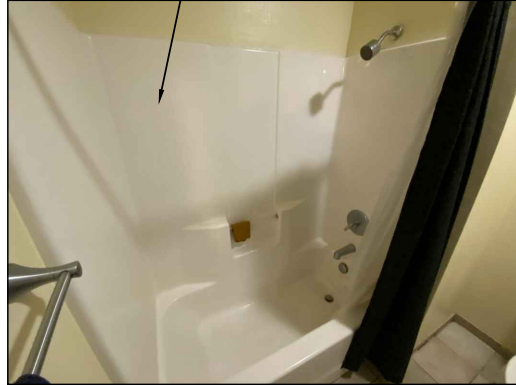

1 PHOTO @ BATHTUB #1  
A-143 N.T.S.

RELOCATE EXISTING OUTLETS TO BE 26" TYPICAL FROM CORNER. PROVIDE EXTENDED OUTLET BOXES AT EACH OUTLET



2 PHOTO @ ENTRY DOOR  
A-143 N.T.S.

MODIFY THRESHOLD TO ACCEPT BEVELED THRESHOLD TO MEET CODE.

EXISTING MAILBOX SUITE BLANK BOXES ABOVE 48" AND WITHIN 24" OF CORNER



3 PHOTO @ HANDICAP BATHTUB  
A-143 N.T.S.

RELOCATE EXISTING OUTLETS TO BE 36" TYPICAL FROM CORNER. PROVIDE EXTENDED OUTLET BOXES AT EACH OUTLET TO MAKE OUTLET 25-1/2" MIN FROM EDGE OF COUNTER.



4 PHOTO @ KITCHEN #1  
A-143 N.T.S.

PROVIDE EXTENDED OUTLET BOX TO MAKE BOX 25-1/2" FROM EDGE OF COUNTER.

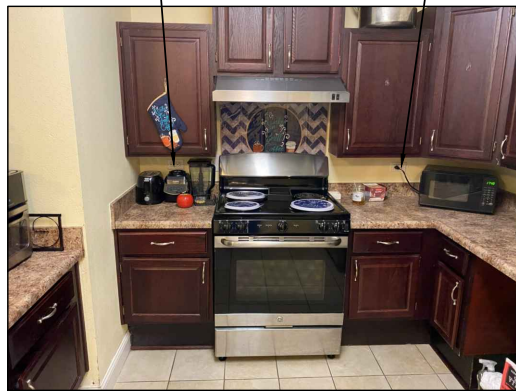

5 PHOTO @ KITCHEN #2  
A-143 N.T.S.

RELOCATE THERMOSTAT TO NEW LOCATION TO BE DETERMINED IN FIELD

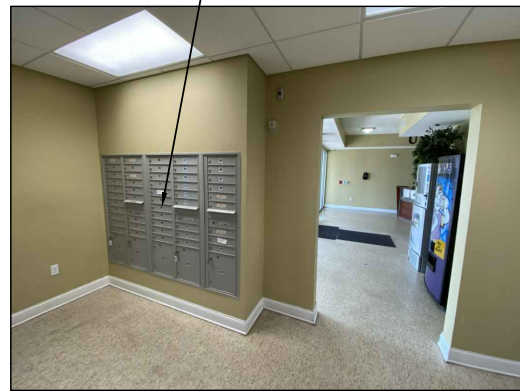

6 PHOTO @ MAILBOX (NOT COMPLIANT)  
A-143 N.T.S.

NOTE: SEE #2, A-141 FOR NEW MAILBOX TO BE ADDED TO ROOM.

LOW THERMOSTAT TO 48" TO ANY BUTTON



7 PHOTO @ OUTSIDE BALCONY DOOR BOTTOM  
A-143 N.T.S.

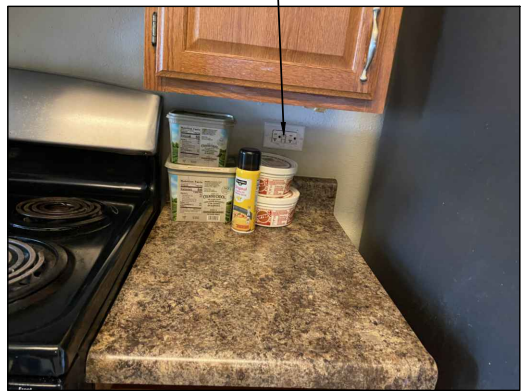

8 PHOTO @ PLUG IN KITCHEN (NOT COMPLIANT)  
A-143 N.T.S.

PROVIDE NEW FURR-OUT WALK FOR NEW MAILBOX SUITES PER DETAIL.



9 PHOTO @ THERMOSTAT (SHIFT)  
A-143 N.T.S.



10 PHOTO @ THERMOSTAT (TO BE LOWERED)  
A-143 N.T.S.

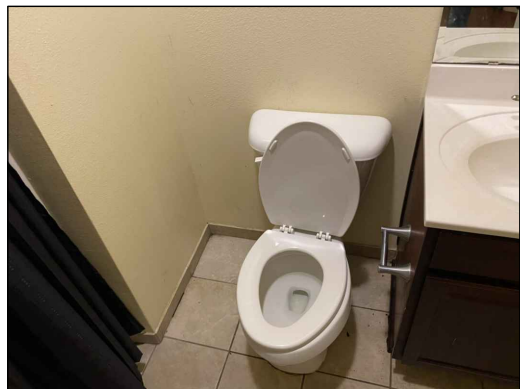

11 PHOTO @ TOILET #1  
A-143 N.T.S.

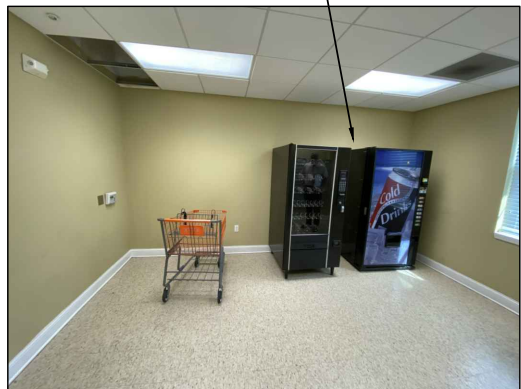

12 PHOTO @ VENDING MACHINES (KEYPADS NOT COMPLIANT)  
A-143 N.T.S.

NOTE: VENDING MACHINES HAVE BEEN REMOVED.

**ECM Consultants, Inc.**  
ARCHITECTS - CONSTRUCTION MANAGERS  
1301 CLEARVIEW PKWY. SUITE 200  
METAIRIE, LOUISIANA 70001  
PHONE: (504) 885-4080, FAX: (504) 885-1439  
EMAIL: mail@ecmconsultants.com

OWNER:  
HOUSING AUTHORITY  
OF NEW ORLEANS  
2051 SENATE ST. BUILDING B, RM. 202  
NEW ORLEANS, LOUISIANA 70122

PROJECT:  
GUSTE III COMMUNITY  
INTERIOR & EXTERIOR REPAIRS  
SHEET TITLE:  
PHOTOS

DRAWN  
M.L.M. & A.E.D.  
CHECKED  
N.G.W.  
DATE  
JUN. 21, 2024  
SCALE  
AS SHOWN  
JOB NO.  
22462.14  
SHEET NO.

# APPENDIX B

## PROJECT GENERAL NOTES

- These Drawings are a part of the Contract Documents. See the Project Manual for a list of the Contract Documents.
- The Contractor shall verify all relevant dimensions and field conditions and shall notify the Architect of any discrepancies between existing field conditions and how they are portrayed in these drawings. Contractor shall verify the fit of all proposed construction.
- The Contractor shall make a reasonable effort to prevent hazards & inconveniences to tenants, guests, property management personnel, grounds maintenance personnel, neighbors, and the general public. The Contractor shall make a reasonable effort to provide for the safety of persons on site and on the adjacent public right of ways and shall secure any necessary City permits for barricades, signs, covered walks or other safety features. Such safety features, as deemed to be reasonable, shall be within the Contractor's scope of work.
- The Contractor shall ensure that all workers are provided with reasonable gear and equipment for personal safety and that all workers on the site have had reasonable training in safety procedures. The Contractor shall ensure that all Contractor personnel at the project site are covered with Workers' Compensation insurance.
- The Contractor shall provide reasonable protection to prevent damage to all new (and existing to remain) work, materials, equipment, and existing structures, finishes, plants, soil, grading, and furnishings. The Contractor shall also take reasonable precautions to protect adjacent City property and utilities. Any damaged items shall be quickly replaced or repaired by the Contractor at the Contractor's expense. Turf grass is explicitly included.
- All materials, fixtures, etc. shall be new unless otherwise specified and shall be handled & installed according to all of the manufacturers' instructions & recommendations. Should the Contractor discover an apparent discrepancy between the manufacturer's instructions & recommendations and the Architect's instructions (including these documents), the Contractor shall immediately bring the discrepancy to the Architect's attention.
- The Contractor shall acquire all the required permits to perform the work, and the work shall comply with all applicable codes & laws. Should the Contractor discover an apparent discrepancy between applicable codes & laws and the Designer's instructions (including these documents), the Contractor shall immediately bring the discrepancy to the Architect's attention.
- The Contractor shall carry insurance as indicated in the Project Manual for the entire duration of the work, and the Contractor shall promptly provide documentation of such insurance when requested by the Architect or Owner. The Architect and the Owner shall be named as insured on the Contractor's General Liability policy, and the Contractor shall provide certificates of insurance indicating so prior to commencement of the Contractor's on-site operations.
- The Contractor shall price and perform all work necessary to legally complete the Work as described in this drawing set. Provide all necessary incidental and prerequisite work, whether or not the necessary incidental and prerequisite work is specifically indicated. (Exception: No remediation of existing materials regulated by the Environmental Protection Agency or the Louisiana Department of Environmental Quality is required as Base Bid work, and no such work is expected by the Architect to be required.)
- The Contractor shall provide security measures during construction as required to reasonably protect the work area and Contractor storage areas from vandalism and theft.
- The Contractor shall promptly notify the Architect if any discrepancies within the Contract Documents are discovered. In the absence of prompt feedback from the Architect, the Specifications documents shall supercede the Drawings. If there are discrepancies within the Drawings or within the Specifications that are not clarified by the Architect prior to the submission of construction bids, the construction bid shall be for the most costly of the conflicting work items.
- Except as specifically indicated in the Drawings and Specifications, all indicated Work shall be included in the Base Bid.
- Provide a Final Cleaning as per the Specifications throughout all areas at which work is done and at all areas of the sites utilized by the Contractor. Also, provide a Final Cleaning as per the Specifications at all areas used by the Contractor for temporary facilities and at all areas used by the Contractor for movement of personnel, equipment, and materials.
- See Specifications regarding demolition. In addition to all demolition specifically indicated in these Drawings, provide all demolition work that is prerequisite to the proposed new construction.
- Prior to bidding, all Bidders shall observe all sides of the building from the adjacent public streets and shall thereby familiarize themselves with the visible existing conditions as they relate to the Work.

## ABBREVIATIONS

Abv.	ABOVE
A/C	AIR CONDITIONING
ADA	AMERICANS WITH DISABILITIES ACT
AFF	ABOVE FINISHED FLOOR
AHU	AIR HANDLING UNIT
Alum.	ALUMINUM
Approx.	APPROXIMATE(LY)
Apt.	APARTMENT
Arch.	ARCHITECT(URAL)
ASF	ABOVE SUB-FLOOR
Bo.	BOARD
BFE	BASE FLOOD ELEVATION
Bldg.	BUILDING
Bk.	BLOCK(ING)
Bm.	BEAM
BTm.	BALCONY TYPE
BTm.	BOTTOM
BTwn.	BETWEEN
Cem.	CEMENT
CJ	CONTROL JOINT
CL	CENTERLINE
Clg.	CEILING
CMU	CONCRETE MASONRY UNIT
Col.	COLUMN
Conc.	CONCRETE
Cont.	CONTINUOUS
Cu Yds	CUBIC YARDS
Dbl.	DOUBLE
Demo.	DEMOLISH, DEMOLITION
Diag.	DIAGONAL
Dim.	DIMENSION
DN	DOWN
Dr.	DOOR
DS	DOWNSPOUT
DD	DETAIL
DIW	DISHWASHER
DWG	DRAWING
EFS	EXTERIOR INSULATING FINISH SYSTEM
EJ	EXPANSION JOINT
Elec.	ELECTRIC(AL)
Elev.	ELEVATION
EQ	EQUAL
Exist.	EXISTING
Ext.	EXTERIOR
FE	FIRE EXTINGUISHER
FL	FOOT (FEET)
Galv.	GALVANIZED
GF	GROUND FAULT CIRCUIT INTERRUPTER
Gyp.	GYPSON
HANO	HOUSING AUTHORITY OF NEW ORLEANS
HB	HOSE BIB
Ht.	HEIGHT
HVAC	HEATING/VENTILATING/AIR CONDITIONING
ID	INNER DIAMETER
In.	INCHES
Insl.	INSULATION, INSULATING
Int.	INTERIOR
J-BOX	JUNCTION BOX
Lav.	LAVATORY
Lb.	POUND (S)
Max.	MAXIMUM
MECH	MECHANICAL
MEP	MECHANICAL/ELECTRICAL/PLUMBING
MH	MEASURING HEIGHT
Min.	MINIMUM
Misc.	MISCELLANEOUS
MO	MASONRY OPENING
Mtl.	METAL
NIC	NOT IN CONTRACT
NTS	NOT TO SCALE
OC	ON CENTER(S)
OD	OUTER DIAMETER
Plywd.	PLYWOOD
PSI	POUNDS PER SQUARE INCH
PT	PRESERVATIVE TREATED
Ptd.	PAINTED
PVC	POLYVINYL CHLORIDE
Qty.	QUANTITY
R/A	RETURN AIR
Reqd	REQUIRED
RO	ROUGH OPENING
Sec	SECTION
Sht.	SHEET
Sim.	SIMILAR
SC	SOLID CORE
Spec	SPECIFICATION, SPECIFIED
Sq.	SQUARE
SS	STAINLESS STEEL
Std.	STANDARD
Stl.	STEEL
Svc.	SERVICE
T&G	TONGUE AND GROOVE
Thk.	THICK(NESS)
Typ.	TYPICAL
UL	UNDERWRITERS LABORATORIES (UL, LLC)
UNO	UNLESS NOTED OTHERWISE
Vert.	VERTICAL
VIF	VERIFY IN FIELD
W/	WITH
Wd.	WOOD
Wdw.	WINDOW
WH	WATER HEATER
W/O	WITHOUT
WP	WATERPROOF
Yr.	YEAR(S)

### Notes on Abbreviations:

- The use of punctuation and capitalization may vary in the Drawings and Specifications; meanings shall nonetheless be as indicated above.
- Industry standard abbreviations may be used in the Contract Documents in addition to the abbreviations listed above.

## SCHEDULE OF BALCONY TYPES

Balcony Type (BT)	Quantity	Approx. Deck Area	Approx. Deck Dimensions (W X D)	Column-supported or cantilevered	Adjacent exterior wall finish
1	2	440 SF	not rectangular**	column-supported	brick
2	2	38 SF	9'-0" X 4'-9"	cantilevered	brick
3	10	93 SF	14'-8" X 6'-4"	column-supported	stucco
4	6	70 SF	14'-8" X 4'-9"	cantilevered	brick
5	4	153 SF	24'-1" X 6'-4"	column-supported	stucco
6	3	42 SF	9'-0" X 4'-9"	cantilevered	brick
7	2	94 SF	14'-9" X 6'-4"	column-supported	brick
8	3	N/A	N/A	N/A	stucco
9	3	N/A	N/A	N/A	stucco

\*Depth dimension is from low edge (drip edge) of existing deck to existing wall framing.  
\*\*See Sheet A-1 for Floor Plan of non-rectangular Balcony Type (BT) 1.

## SCHEDULE OF LIVING UNITS WITH BALCONIES

Floor	Living Unit (Apartment)	Unit Type	Balcony Type (BT)	Scope of work
2	201	F	1	S&D
	202	G	2	S&D
	203	A	3	D
	204	A	4	S&D
	205	D	5	S&D
	206	A	7	D
	207	A	3	S&D
	208	A	3	S&D
	209	A	5	D
	210	A	4	S&D
3	211	A	3	D
	212	C	6	S&D
	213	B	3	D
	301	H	1	S&D
	302	J	2	S&D
	303	A	3	D
	304	A	4	S&D
	305	D	5	S&D
	306	A	3	D
	307	A	3	D
4	308	A	3	D
	309	A	5	D
	310	A	4	S&D
	311	A	3	S&D
	312	C	6	S&D
	313	B	3	D
	401	K	N/A	none
	402 (not used)	N/A	N/A	none
	403	A	8	none
	404	A	4	S&D
405 (not used)	N/A	N/A	none	
406	A	8	none	
407	A2	9	none	
408	A	9	none	
409	A	N/A	none	
410	A	4	S&D	
411	A	9	none	
412	C	6	S&D	
413	B	8	none	

### Key to Scope of Work Column

S&D: Re-slope and re-deck balcony. Remove and re-install ferrous metal column base. Remove wood sleepers and provide new wood sleepers. Provide new steel trim. Re-paint all painted ferrous metal, and paint new steel trim.

D: Re-deck balcony. Re-paint all painted ferrous metal. Repair wood sleepers.

none: No improvements at this balcony. This is a "Juliet Balcony" without tongue-and-groove decking.

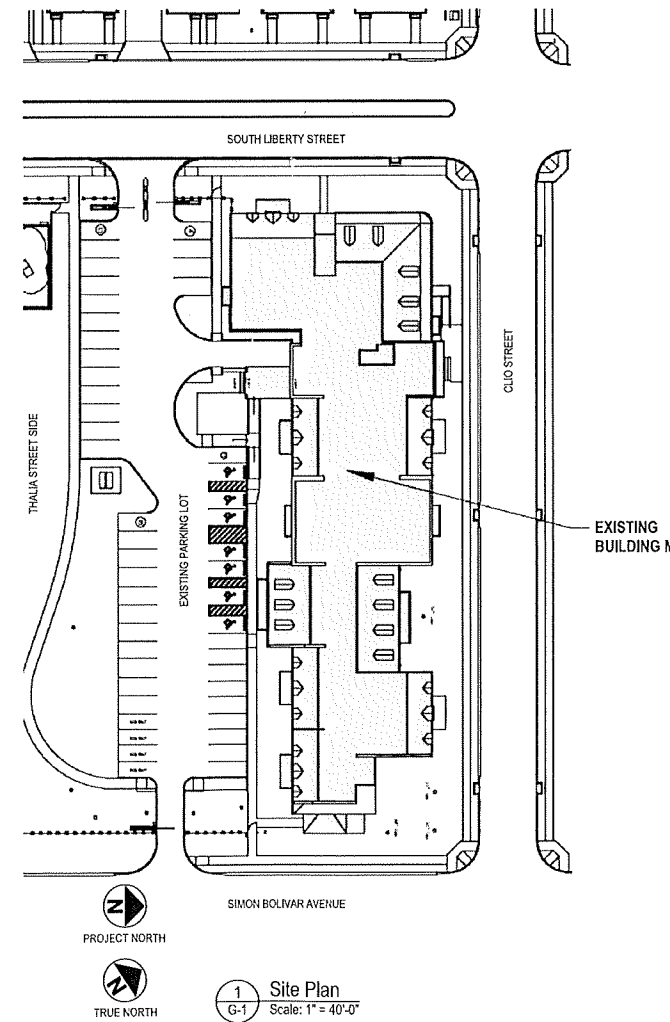

## INDEX OF DRAWINGS

	GENERAL
G-1	Index of Drawings, Site Plan, Misc.
ARCHITECTURAL	
A-1	Floor Plans
A-2	Exterior Elevations, Alterations to Existing Metalwork
A-3	Details

## BUILDING & OCCUPANCY INFORMATION

The Work is to be performed at one (1) four-story building. The building use is Multi-Family housing.

Use and Occupancy Classification as per Chapter 3 of the International Building Code (IBC), 2015 edition: Residential, Group R-2, Apartment House.

Floor Area: no change to existing floor area

## PROJECT DIRECTORY

**OWNER:**  
Housing Authority of New Orleans (HANO)  
Langston Ford, Project Manager  
4100 Touro St.  
New Orleans, LA 70122  
phone: 504-670-3324  
lford@hano.org

**ARCHITECT:**  
Volume Zero, LLC  
Michael Cajski, Project Architect  
1034 Joliet St.  
New Orleans, LA 70118  
phone: 504-864-9909  
fax: 504-864-9983  
michael@volumezero.com

Volume (Zero)

architectural design studio

Vol 0

1034 Joliet Street  
New Orleans, LA 70118  
504-864-9909 phone  
504-864-9983 fax

a limited liability company  
Michael Cajski &  
Van Tran Architects



Housing Authority of New Orleans  
**BALCONY ALTERATIONS**  
at the Guste III Housing Community, Building M  
2100 Clio Street, New Orleans, Louisiana

Issue and print dates:  
December 12, 2022 - Bid Issue

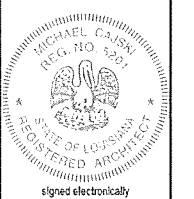

signed electronically  
Michael Cajski  
Registered Architect #5201

Architect's project no. 22-013  
drawn by MC

sheet no.

G-1

NOTE: BT = Balcony Type

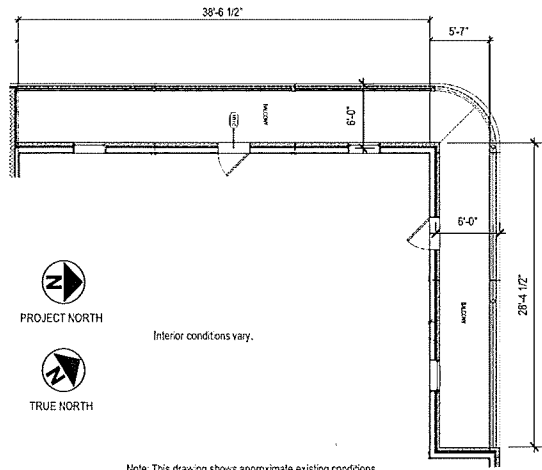

Note: This drawing shows approximate existing conditions.  
**5** Balcony Type (BT) 1 Floor Plan  
 Scale: 1/8" = 1'-0"

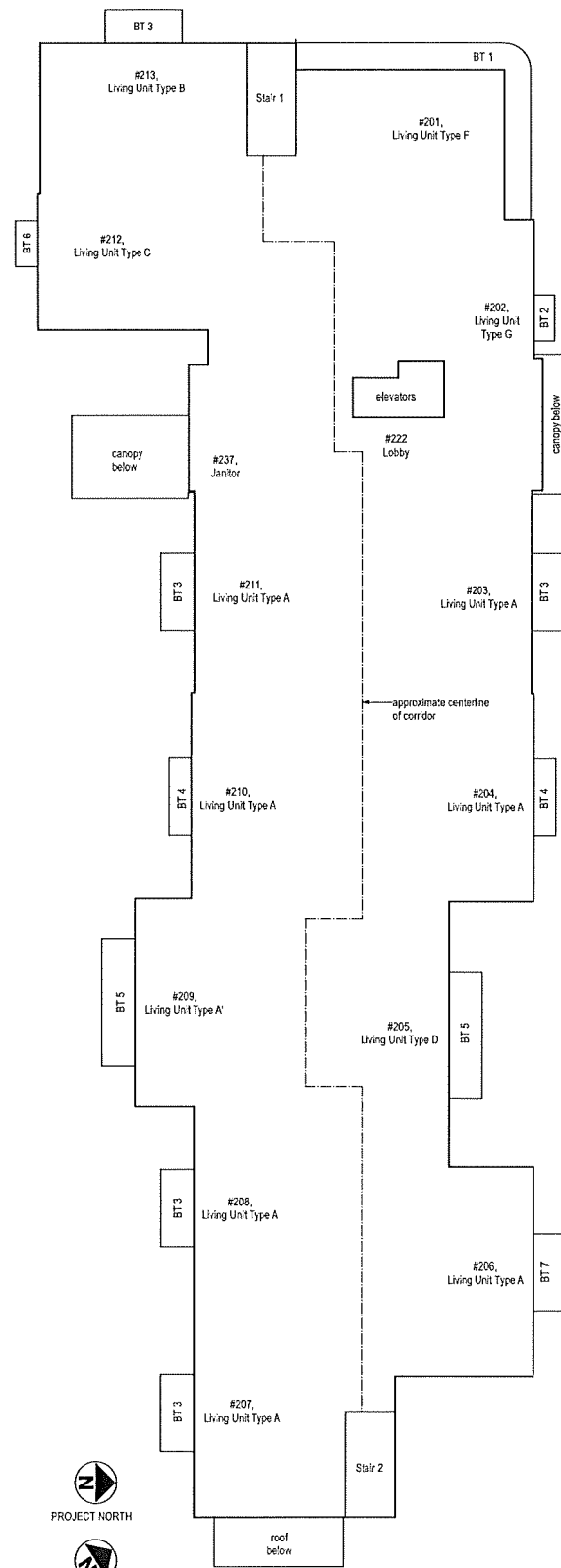

PROJECT NORTH  
 TRUE NORTH

**2** Second Floor Plan  
 Scale: 1/16" = 1'-0"

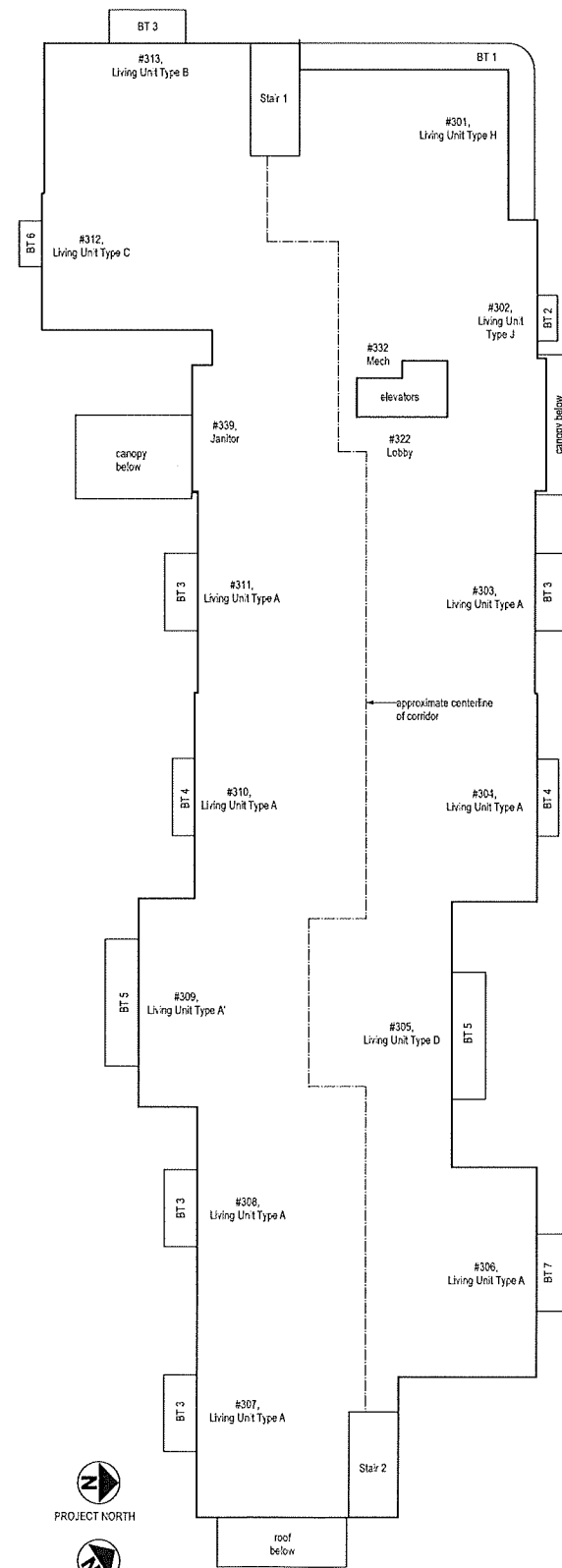

PROJECT NORTH  
 TRUE NORTH

**3** Third Floor Plan  
 Scale: 1/16" = 1'-0"

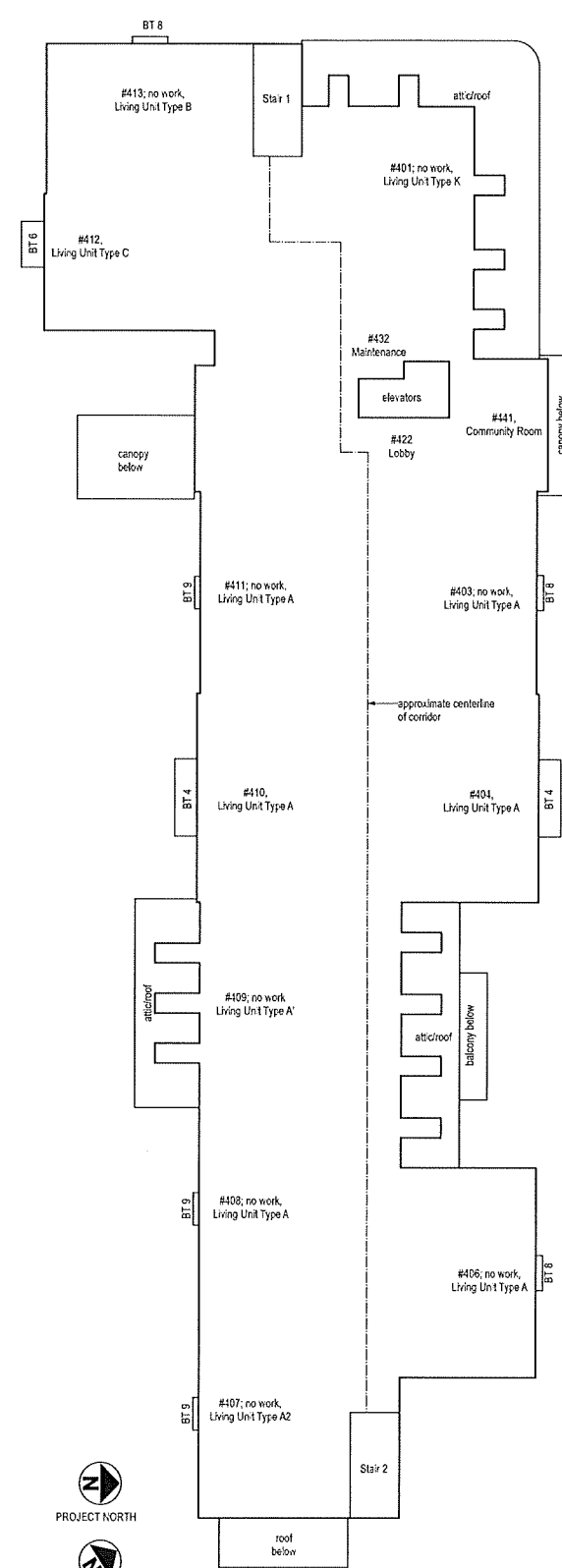

PROJECT NORTH  
 TRUE NORTH

**4** Fourth Floor Plan  
 Scale: 1/16" = 1'-0"

**1** (not used)  
 Scale: 1/16" = 1'-0"



Housing Authority of New Orleans  
**BALCONY ALTERATIONS**  
 at the Guste III Housing Community, Building M  
 2100 Clio Street, New Orleans, Louisiana

issue and print dates:  
 December 12, 2022 - Bid Issue

signed electronically  
 Michael Cajski  
 Registered Architect #5201  
 Architect's project no. 22-013  
 drawn by MC  
 sheet no.



NOTE: BT = Balcony Type



Housing Authority of New Orleans  
**BALCONY ALTERATIONS**  
 at the Guste III Housing Community, Building M  
 2100 Clito Street, New Orleans, Louisiana

Issue and print dates:  
 December 12, 2022 - Bid Issue

signed electronically  
 Michael Cajski  
 Registered Architect #5201  
 Architect's project no. 22-013  
 drawn by MC  
 sheet no.

**A-2**

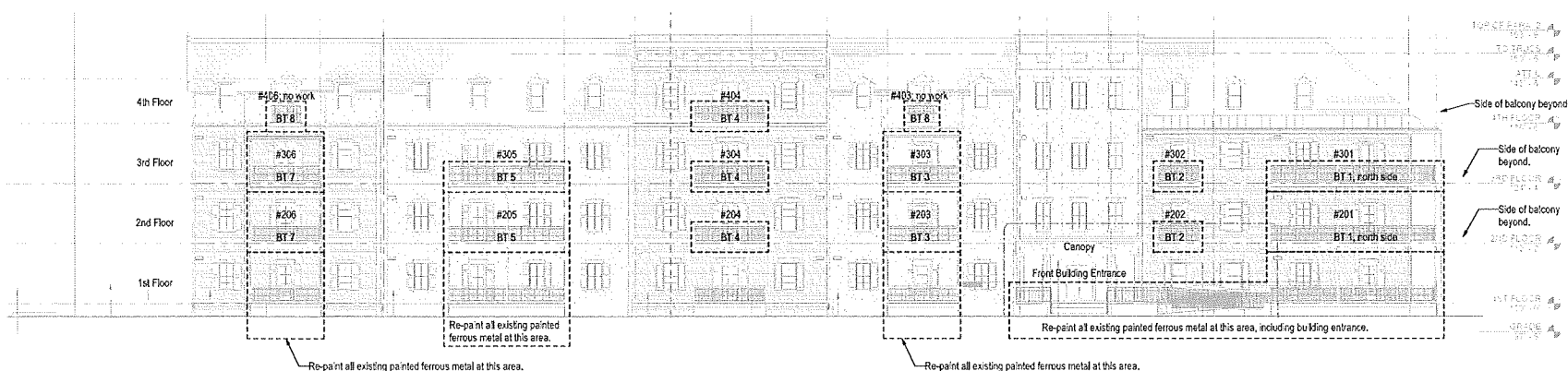

**1 North Elevation (Clito St. Elevation)**  
 Scale: 1/16" = 1'-0"

Note: Exterior Elevations show approximate existing building conditions. Actual conditions may vary.

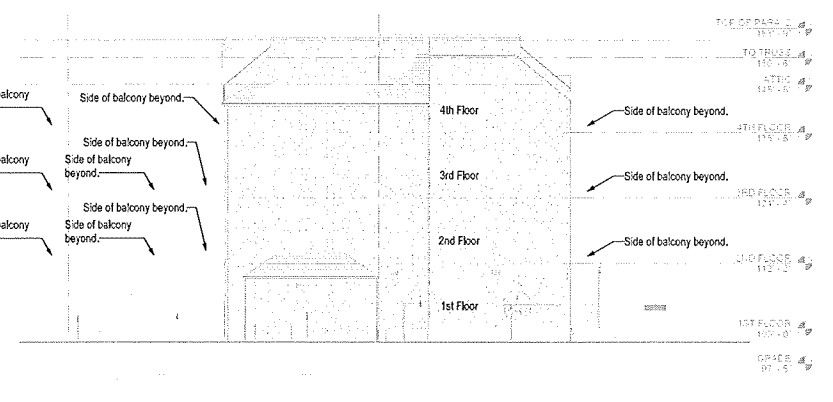

**2 East Elevation (Simon Bolivar Ave. Elevation)**  
 Scale: 1/16" = 1'-0"

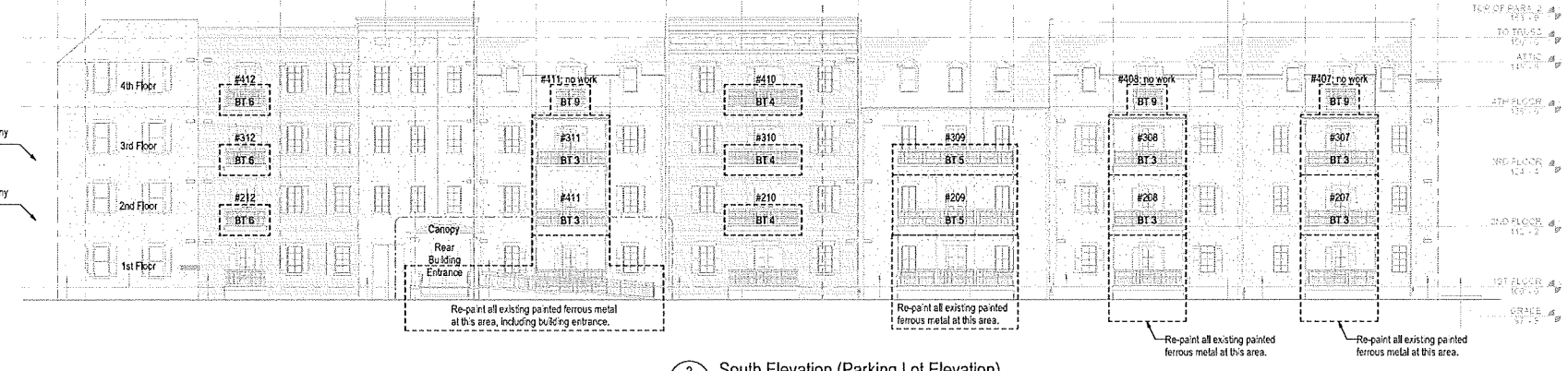

**3 South Elevation (Parking Lot Elevation)**  
 Scale: 1/16" = 1'-0"

Note: Exterior Elevations show approximate existing building conditions. Actual conditions may vary.

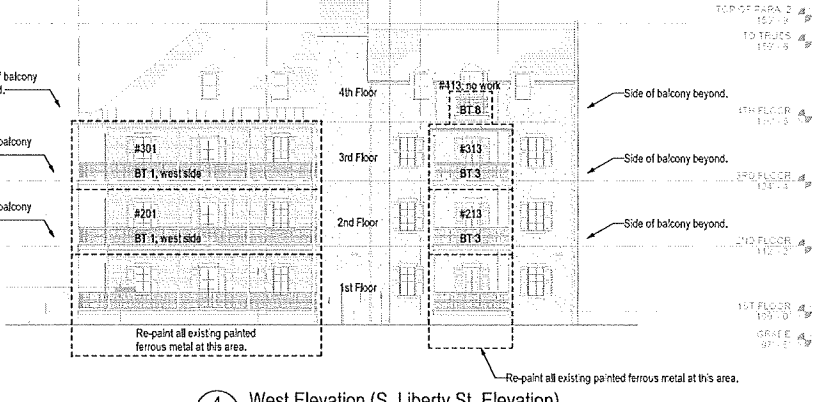

**4 West Elevation (S. Liberty St. Elevation)**  
 Scale: 1/16" = 1'-0"

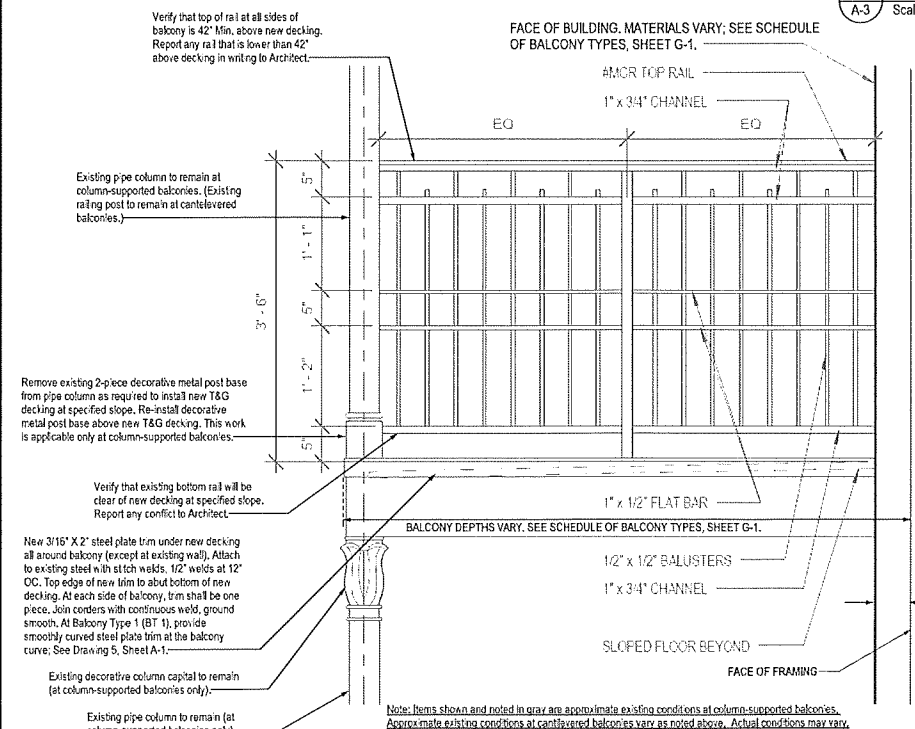

**5 Metalwork: Section at Balcony**  
 Scale: 1" = 1'-0"

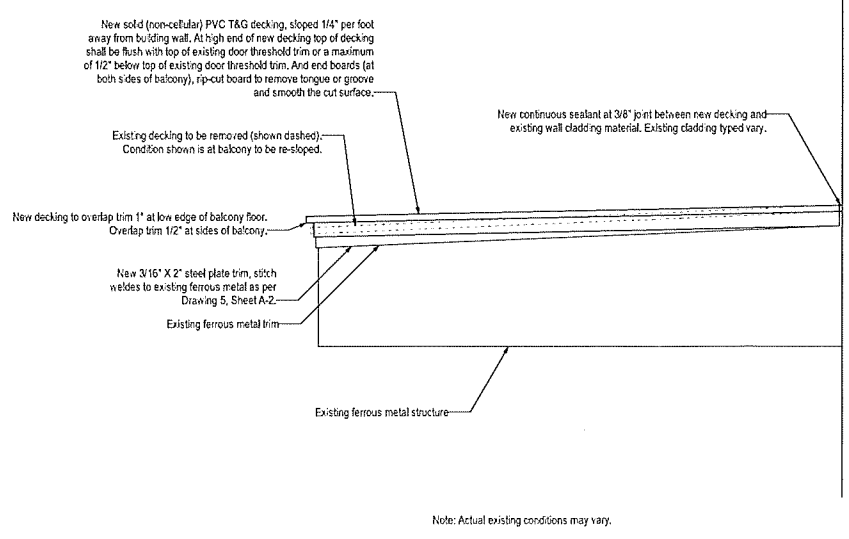

**6 Side Elevation of Typical Balcony Floor Assembly**  
 Scale: 1" = 1'-0"

Note: Actual existing conditions may vary.



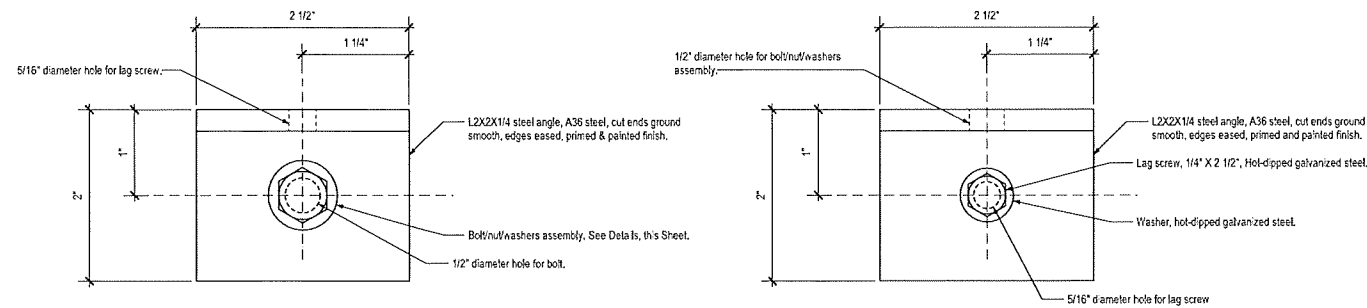

1 Detail: Elevation View of New Bracket  
Scale: Actual Size

2 Detail: Reflected Ceiling View of New Bracket  
Scale: Actual Size

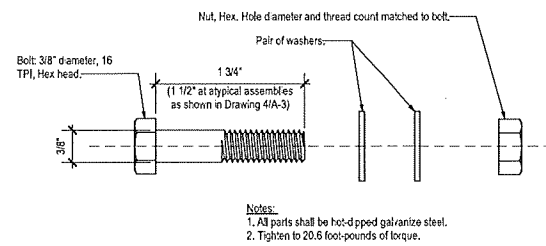

3 Detail: Typical Bolt/Nut/Washers Assembly  
Scale: Actual Size

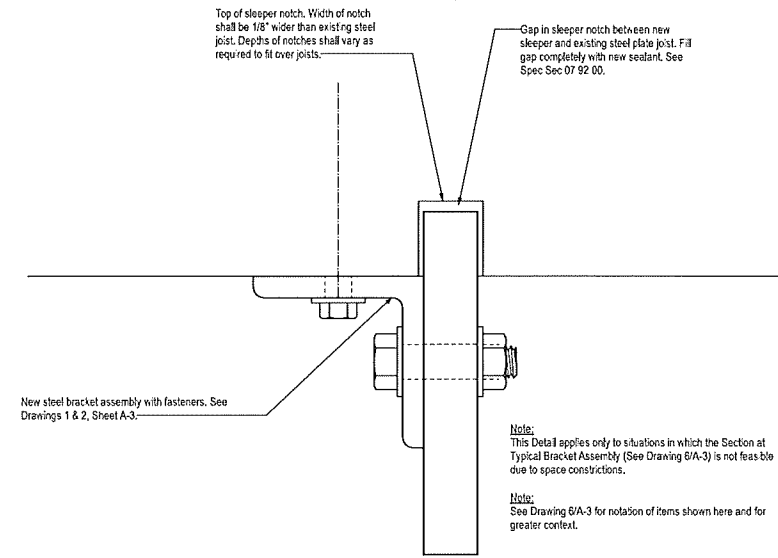

4 Detail: Section at Atypical Bracket Assembly (One Bracket)  
Scale: Actual Size

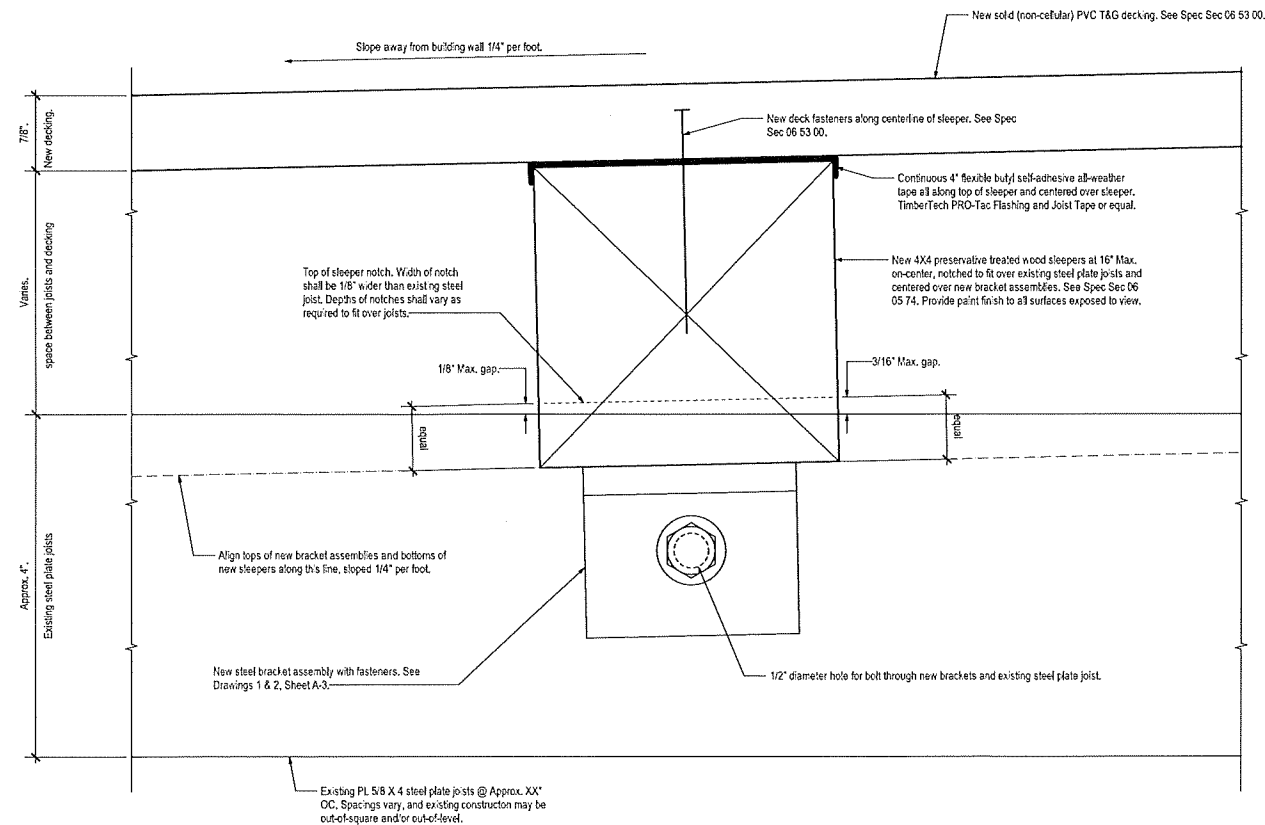

5 Detail: Section Through Typical 4X4 Sleeper  
Scale: Actual Size

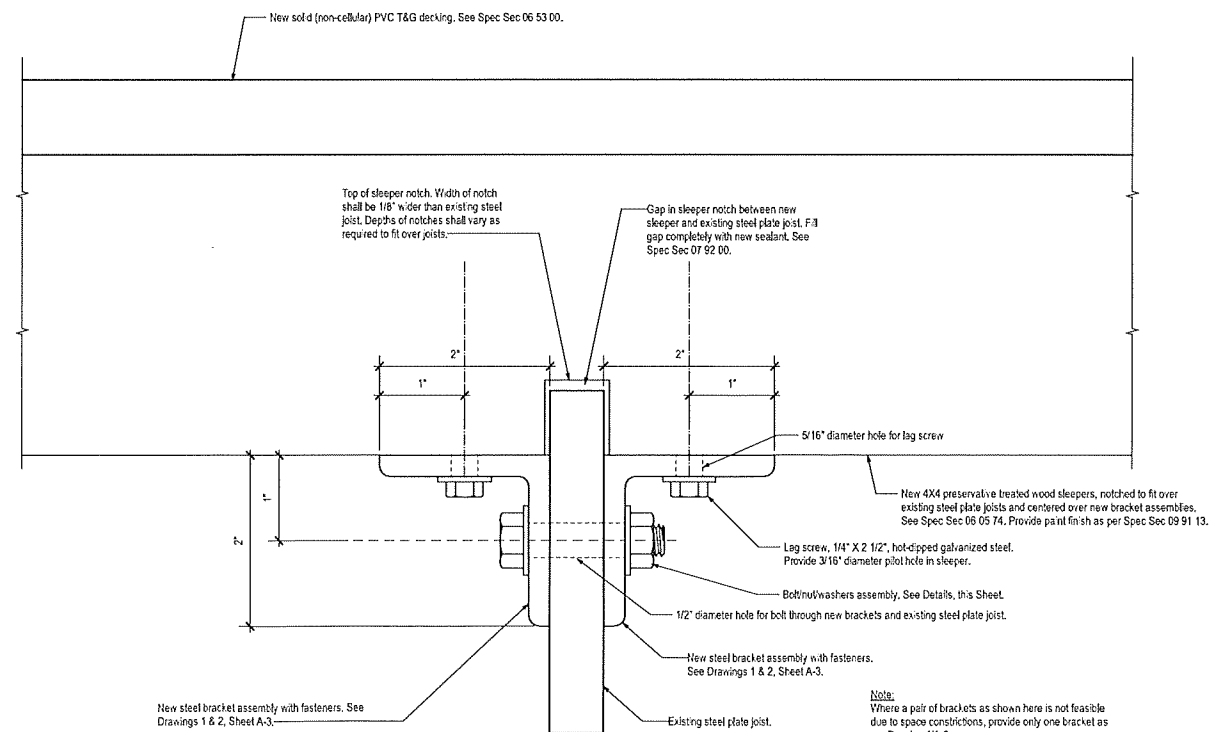

6 Detail: Section at Typical Bracket Assembly (Two Brackets)  
Scale: Actual Size



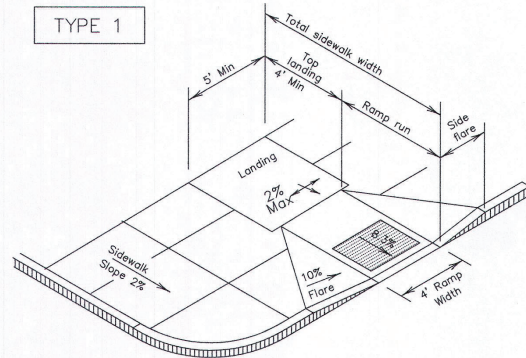

**PERPENDICULAR CURB RAMP**

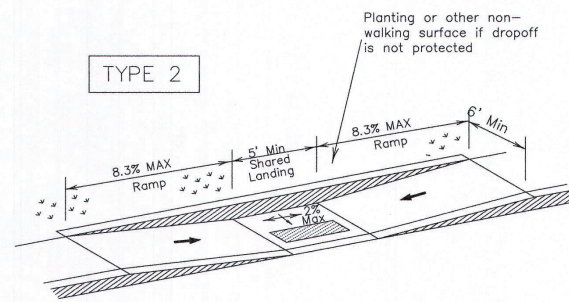

**PARALLEL CURB RAMP**  
(Use only where water will not pond in the landing)

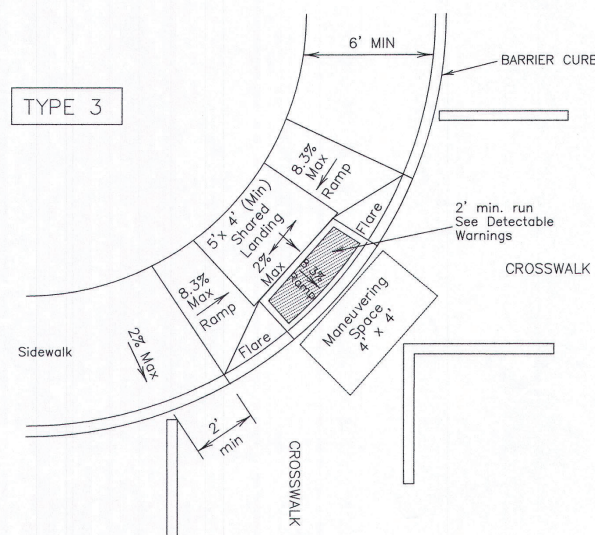

**DIAGONAL COMBINATION CURB RAMP**  
Perpendicular to the Tangent of the Curb Radius and Contained in Crosswalk

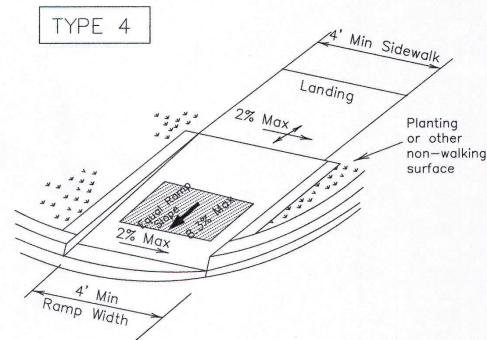

**DIRECTIONAL RAMP WITHIN RADIUS**  
(Sidewalk set back from curb)

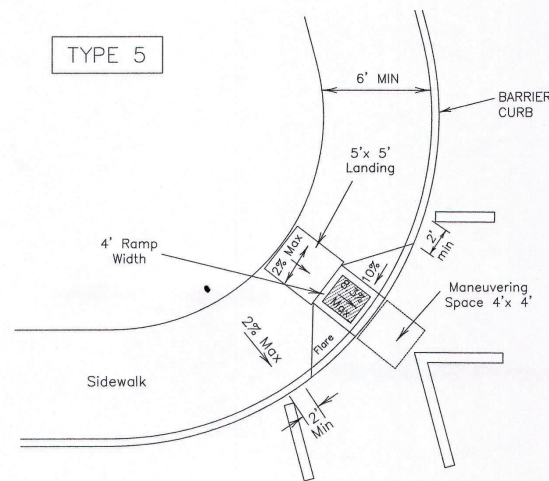

**DIAGONAL CURB RAMP (FLARED SIDES)**  
(PERMISSION FROM CHIEF ENGINEER REQ'D)

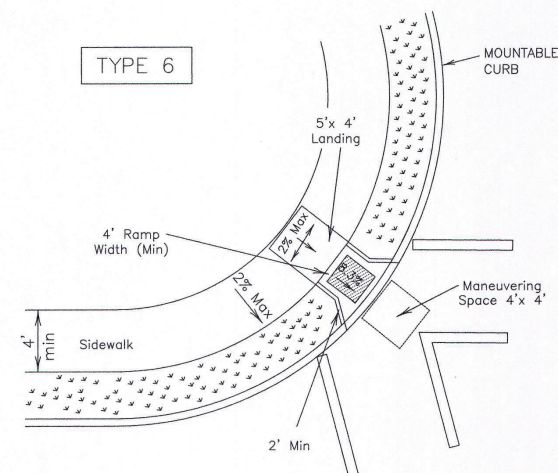

**DIAGONAL CURB RAMP (RETURNED CURB)**  
(PERMISSION FROM CHIEF ENGINEER REQ'D)

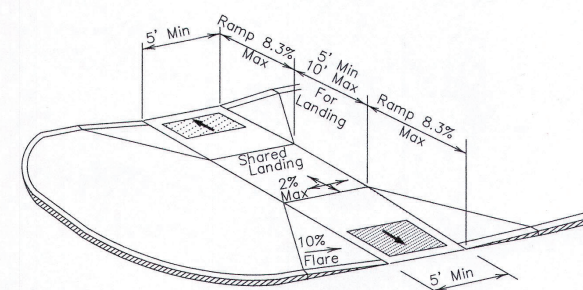

**TYPE 7**

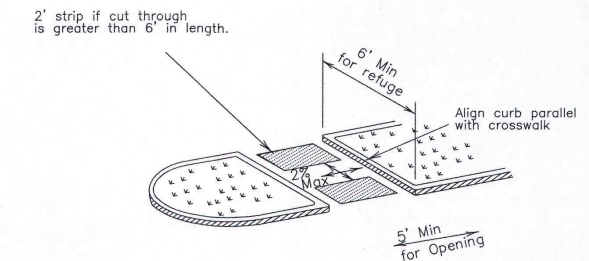

**TYPE 8**

**CURB RAMPS AT MEDIAN ISLANDS**

Detectable warning to be located at Face of Curb for Type 8.

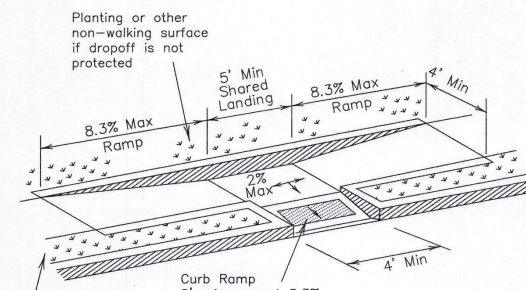

**TYPE 9**

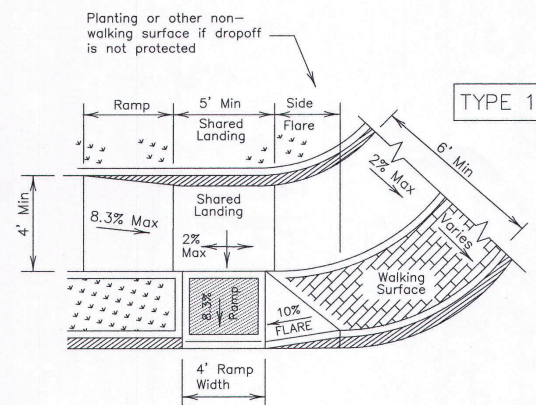

**PERPENDICULAR SIDEWALK RAMP WITH SINGLE FLARE DETAIL**

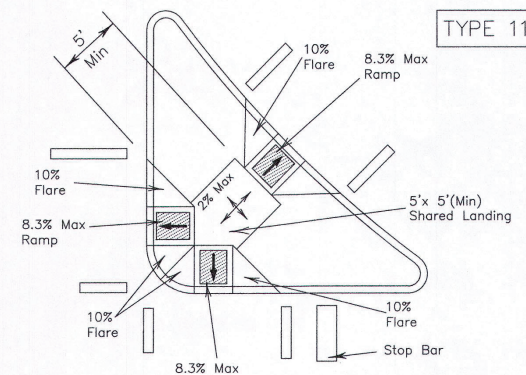

**COMBINATION ISLAND RAMPS**

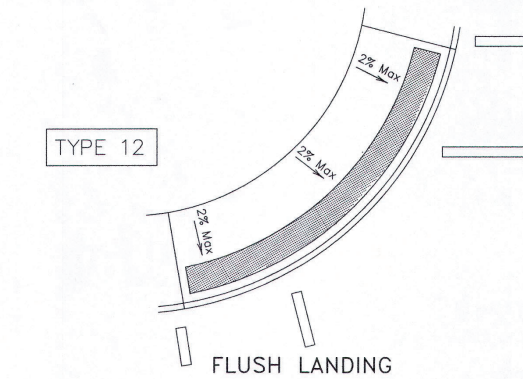

**TYPE 12**

**FLUSH LANDING**

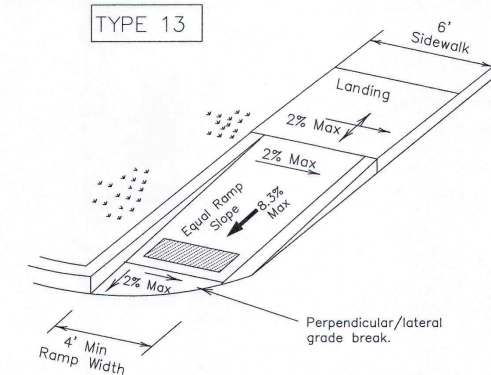

**TYPE 13**

**DIRECTIONAL RAMP WITHIN RADIUS**  
(Sidewalk adjacent to curb)

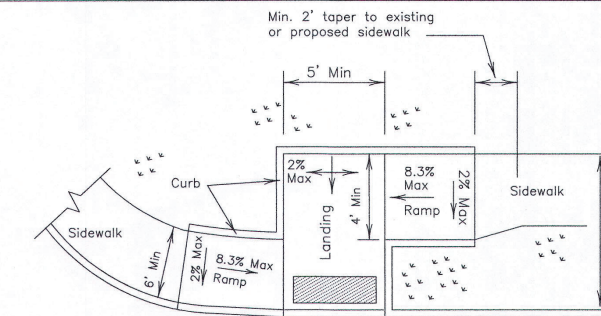

**TYPE 14**

**OFFSET PARALLEL CURB RAMP**

- NOTES:**
1. See General Notes on sheet ADA2 for more information.
  2. Cross slope not to exceed 2% on any portion of ramp or transition to street.

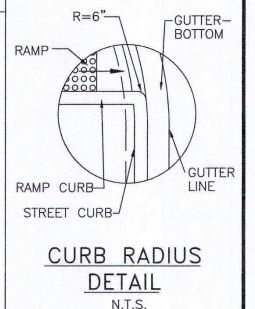

**CURB RADIUS DETAIL**  
N.T.S.

Denotes planting or non-walking surface.

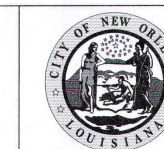

CITY OF NEW ORLEANS  
DEPARTMENT OF PUBLIC WORKS  
ENGINEERING DIVISION

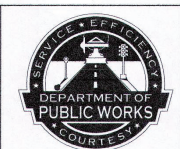

THE SELECTION AND USE OF THESE DETAILS, WHILE DESIGNED IN ACCORDANCE WITH GENERALLY ACCEPTED ENGINEERING PRINCIPLES AND PRACTICES, IS THE SOLE RESPONSIBILITY OF THE USER AND SHOULD NOT BE USED WITHOUT CONSULTING A LOUISIANA REGISTERED PROFESSIONAL ENGINEER.

**CURB RAMPS FOR STREET CONSTRUCTION**

DRAWN BY: J. LARMEU  
REVIEWED BY: A.Y. L.H. N.S.  
RECOMMENDED BY: [Signature]  
ROUTED TO: [Signature], CHIEF ENGINEER

DATE: 2/3/2015  
SCALE: AS NOTED  
APPROVED: [Signature]  
MARK D. JEROME, DIRECTOR

DRAWING No.  
**ADA1**



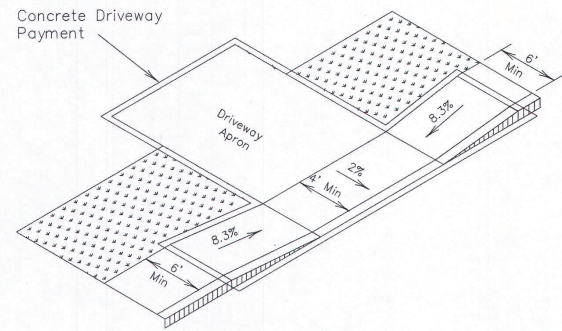

Ramp sidewalk

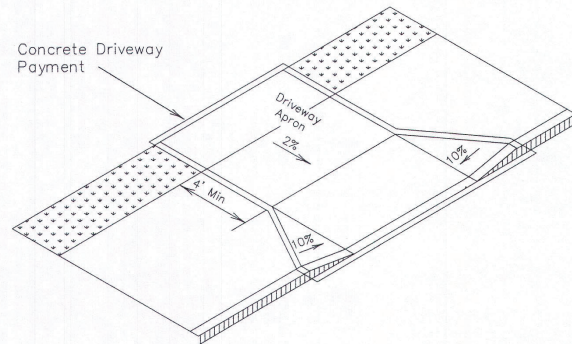

Wide sidewalk

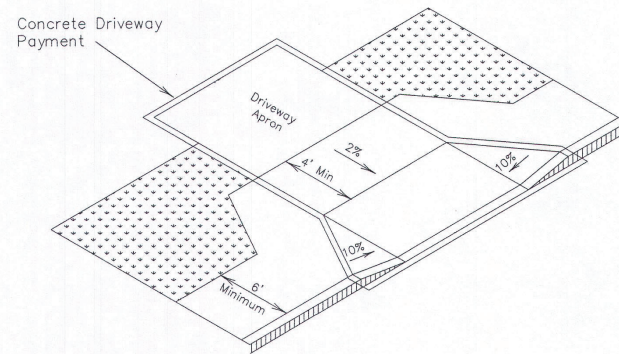

Apron offset sidewalk

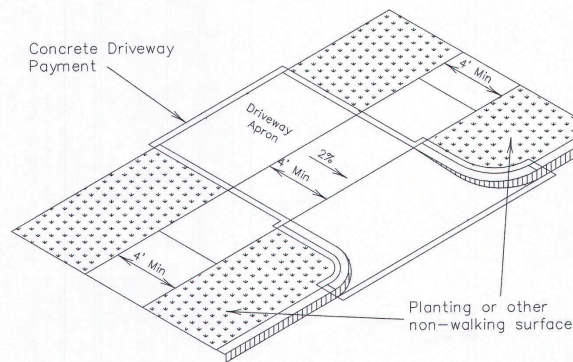

Setback sidewalk

SIDEWALK TREATMENT AT DRIVEWAYS

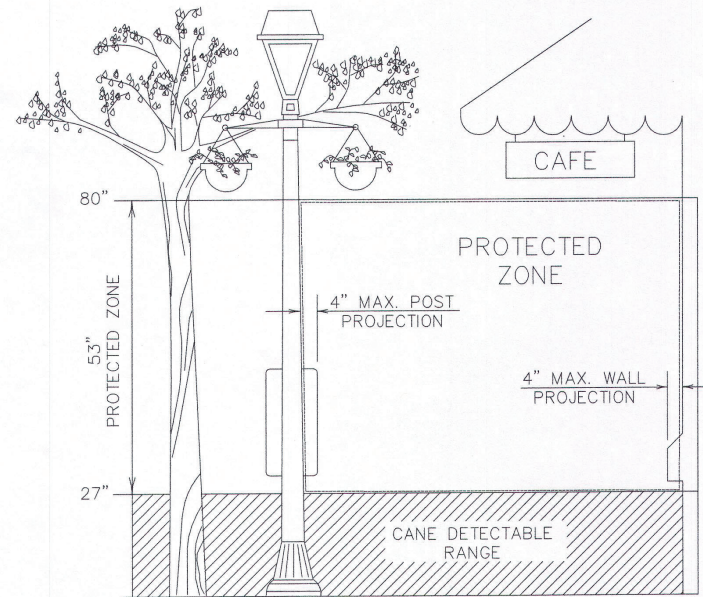

PROTECTED ZONE  
In pedestrian circulation area, maximum 4" projection for post or wall mounted objects between 27" and 80" above the surface.

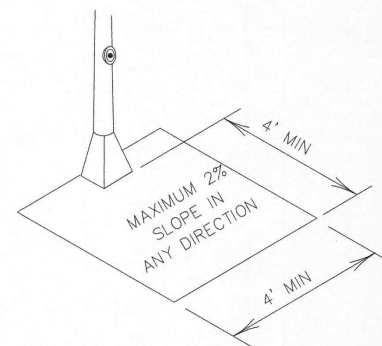

CLEAR GROUND SPACE AT PEDESTRIAN PUSH BUTTON

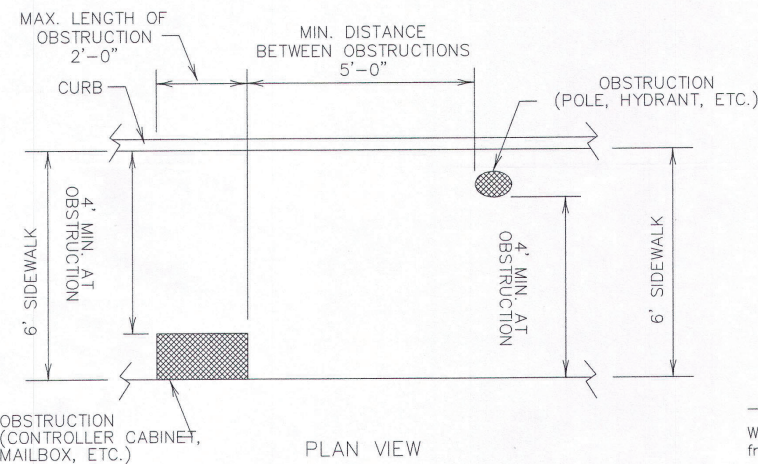

PLAN VIEW  
PLACEMENT OF STREET FIXTURES

(ITEMS NOT INTENDED FOR PUBLIC USE. MINIMUM 4' x 4' CLEAR GROUND SPACE REQUIRED AT PUBLIC USE FIXTURES.)

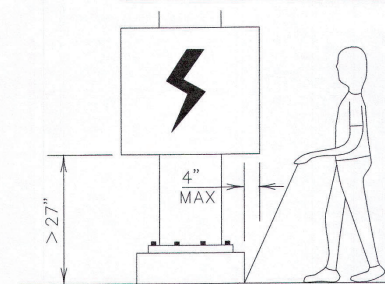

When an obstruction of a height greater than 27" from the surface would create a protrusion of more than 4" into the pedestrian circulation area, construct additional curb or foundation at the bottom to provide a maximum 4" overhang.

DETECTION BARRIER FOR VERTICAL CLEARANCE < 80"

Pedestrian Facilities General Notes

- All slopes shown are maximum allowable. The least possible slope that will still drain properly should be used.
- The minimum sidewalk width is 4', unless otherwise regulated. Where the sidewalk is adjacent to back of a barrier curb, the sidewalk width shall be 6'. Where a 4' sidewalk cannot be provided due to site constraints, a minimum 3' sidewalk with 5' x 5' passing areas at intervals not to exceed 200 ft is required.
- Changes in the level of sidewalk should be no more than 1/4". Changes in level greater than 1/4" but equal to or less than 1/2" may be beveled at a 1:2 maximum slope. Any change of level greater than 1/2" requires a ramp.
- The maximum desirable slope of a curb ramp shall be 8.33% (1:12). Ramp length or grade of approach sidewalks may be adjusted as directed by the Project Engineer. In alterations, curb ramp slope(s) may be 10% for a maximum rise of 6" or 12.5% for a maximum rise of 3". Curb ramps in alterations need not exceed 6' in length.
- Maneuvering space at the bottom of curb ramps shall be a minimum of 4' x 4' wholly contained within the crosswalk and wholly outside the parallel vehicular travel path.
- Maximum allowable cross slope on sidewalk and ramp surfaces is 2%; desired cross slope is 1.5%.
- The desirable landing dimensions are 5' x 5' with a maximum 2% slope in any direction. If a level landing of at least 3' width cannot be provided, perpendicular curb ramps should not be used.
- Curb ramps with returned curbs may only be used where pedestrians would not normally walk across the ramp. Otherwise, flared sides shall be provided.
- All concrete surfaces shall receive a light broom finish unless noted otherwise in the plans.
- Separate curb ramps and landings from adjacent sidewalk and any other elements with pre-mold or board joint of 3/4" unless otherwise directed by the Project Engineer.
- Tooled joints are required at all sidewalk ramp or driveway slope break lines.
- Provide a smooth transition where the curb ramps connect to the street.
- Ramp textures must include truncated domed surfaces. Textures are required to be detectable underfoot. Surfaces that would allow water to accumulate are prohibited. Shaded areas indicate locations of detectable warnings. (Color: light reflective value and texture contrast)
- Note that where sidewalks intersect with streets, detectable warning systems are required at all street crossings.
- Ramps providing access to buildings shall follow the applicable requirements of the Public Right of Way Accessibility Guidelines (PROWAG).
- To serve as a pedestrian refuge area, raised medians should be a minimum of 6' wide, 10' desirable. Medians should be designed to provide accessible passage over or through them.
- Small channelization islands, which cannot provide a minimum 5' x 5' landing at the top of ramps, shall be cut through level with the surface of the street.
- On street parking will not be allowed within 20' of any crosswalks.
- Drainage structures in close proximity to curb ramps should be located on the upstream side of the ramp.
- Traffic signal or illumination poles, ground boxes, controller boxes, signs, drainage facilities and other items shall be placed so as not to obstruct the accessible route.
- Street grades and cross-slopes shall be as shown elsewhere in the plans; however, parabolic crowns may require adjustment in crosswalk areas to limit crosswalk grade to 5%.
- Where existing driveway is in good condition and meets slope requirements, construct only as much as required for satisfactory connection with new work.
- Where gravel driveways occur, at least 10' of the driveway behind the sidewalk should be surfaced to prevent tracking of gravel onto the sidewalk.
- Cross walk dimensions and crosswalk markings shall be as shown elsewhere in the plans. At intersections where crosswalk markings are not required, ramps shall be aligned with theoretical crosswalks or as directed by the Project Engineer.
- Where crosswalks occur, a 24" solid white line shall be placed across all approach lanes to indicate the point behind which vehicles are to stop. Stop bars shall be placed at a minimum 4' in advance of a crosswalk.
- Driveways, sidewalks, and ramps shall be constructed and paid for in accordance with the applicable sections of the Standard Specifications. The limits of payment for handicap ramps shall include but not be limited to curb transition, detectable warning system, gutter, landing and base.
- Though the least possible grade should be used to maximize accessibility, where it is structurally impractical to achieve ADA compliance, the running slope of sidewalks and crosswalks within the public right-of-way, may follow the grade of the parallel roadway without invoking variances or landings or handrails. Where a continuous grade greater than 5% must be provided, handrails may be desirable on one or both sides of the sidewalk to improve accessibility.

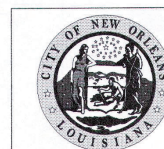

CITY OF NEW ORLEANS  
DEPARTMENT OF PUBLIC WORKS  
ENGINEERING DIVISION

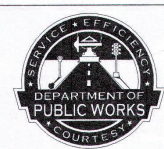

CURB RAMP  
FOR  
STREET CONSTRUCTION

DRAWN BY: J. LARMEU	REVIEWED BY: A.Y. L.H. N.S.	RECOMMENDED BY: NGUYEN D. PHAN, CHIEF ENGINEER
DATE: 2/3/2015	SCALE: AS NOTED	APPROVED: MARK D. JERVIS, DIRECTOR

DRAWING No.

ADA2



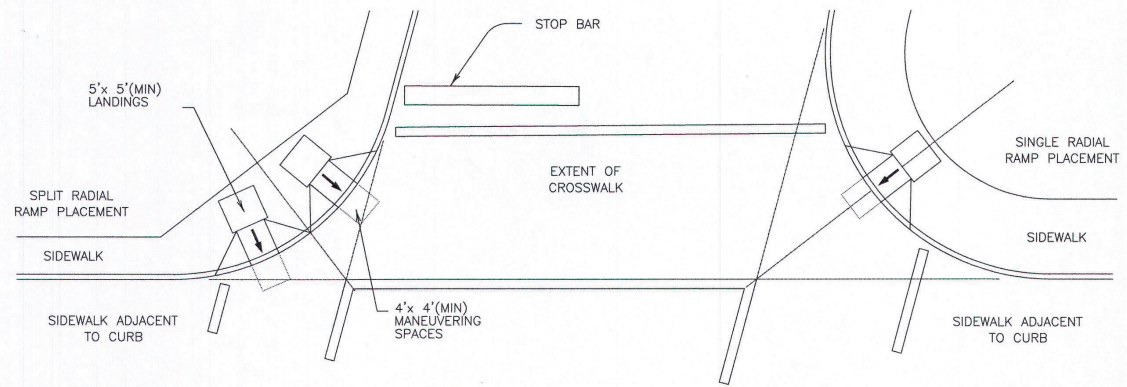

SKewed INTERSECTION WITH "LARGE" RADIUS

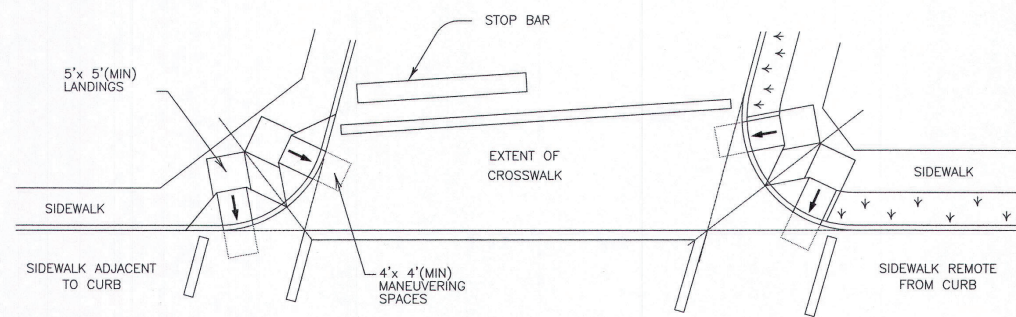

SKewed INTERSECTION WITH "SMALL" RADIUS

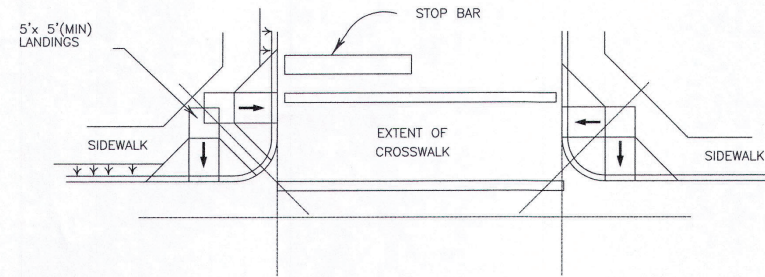

NORMAL INTERSECTION

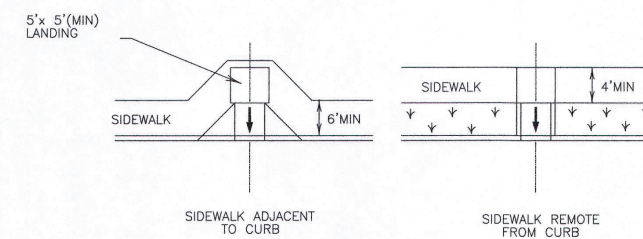
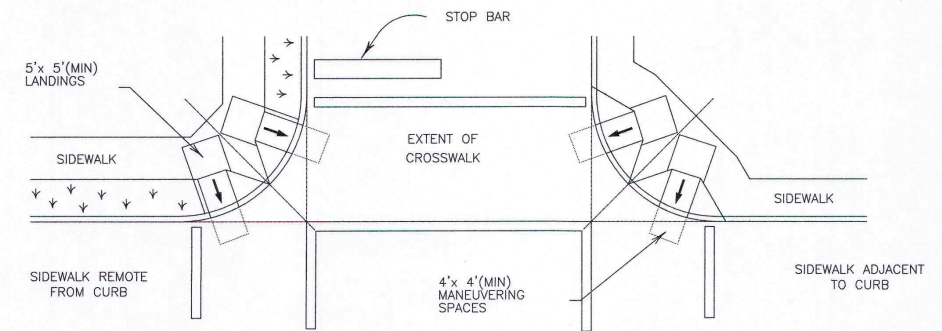

MID-BLOCK PLACEMENT PERPENDICULAR RAMPs

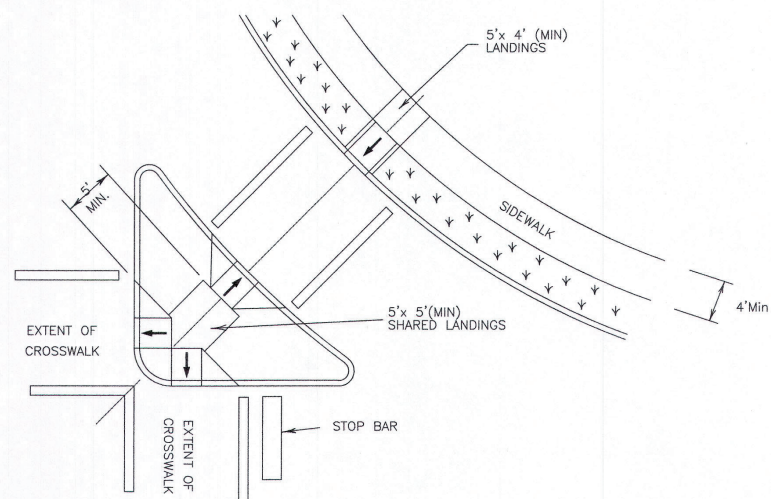



AT INTERSECTION W/FREE RIGHT TURN & ISLAND

General Note:

Ramps are shown here without detectable warnings for simplicity. Detectable warnings are required at the locations shown on Sheet ADA1 and in accordance with the details shown elsewhere herein below.

Striping (Crosswalks and stop bars) is shown for reference only.

See PM1 for Striping Layout.

	CITY OF NEW ORLEANS DEPARTMENT OF PUBLIC WORKS ENGINEERING DIVISION		
	INTERSECTION LAYOUT FOR STREET CONSTRUCTION		
THE SELECTION AND USE OF THESE DETAILS, WHILE DESIGNED IN ACCORDANCE WITH GENERALLY ACCEPTED ENGINEERING PRINCIPLES AND PRACTICES, IS THE SOLE RESPONSIBILITY OF THE USER AND SHOULD NOT BE USED WITHOUT CONSULTING A LOUISIANA REGISTERED PROFESSIONAL ENGINEER.	DRAWN BY: J. LARMEU DATE: 2/3/2015	REVIEWED BY: A.Y. L.H. N.S. SCALE: AS NOTED	RECOMMENDED BY: NGUYEN D. PHAN, CHIEF ENGINEER APPROVED: MARK D. JEROME, DIRECTOR



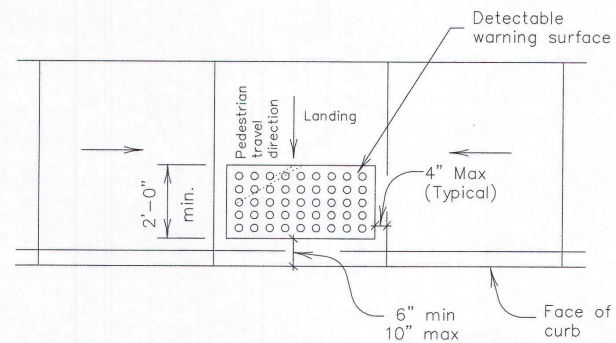

Typical placement of detectable warning surface on landing at street edge.

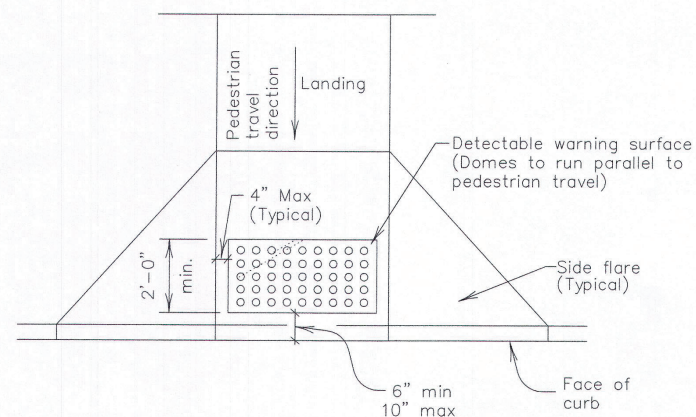

Typical placement of detectable warning surface on sloping ramp run.

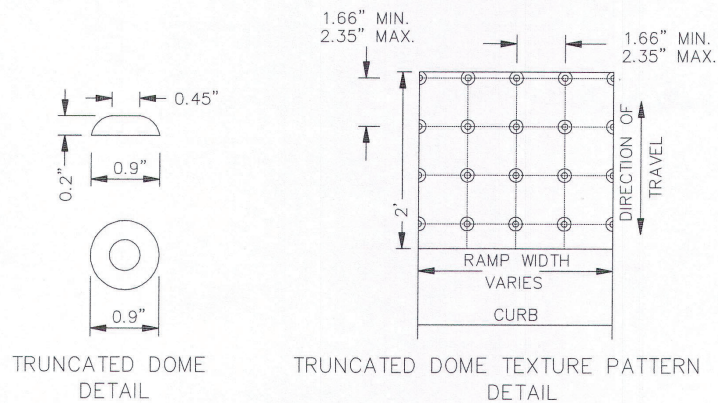

Note: Place truncated domes detectable warning texture in the lower 2' of throat of ramp only and a 3' wide pattern at "at-grade" sidewalk intersections with roadways. Domes shall be arranged in a square in-line pattern only as shown.

\* Note: Retrofit application placed on top of existing ramp with drilled and epoxied bolts. Epoxy full surface area per manufacturer's recommendations. See General Note no. 9

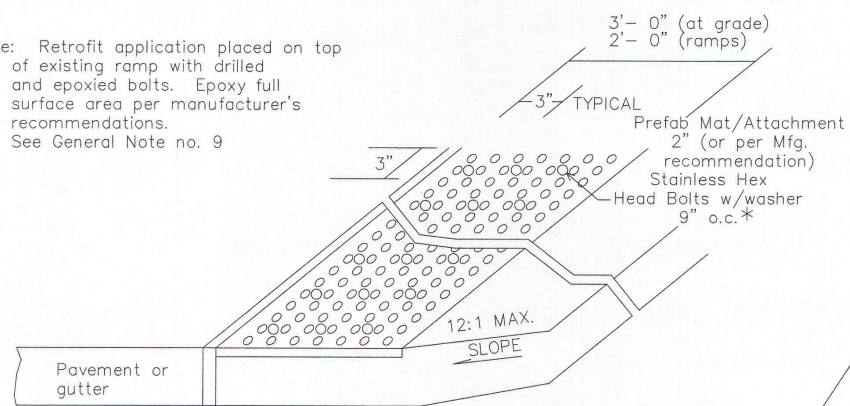

PREFABRICATED MAT OPTION (INLAID)

Expansion material  
Pavement or gutter

Detectable Warnings General Notes

- For PROWAG compliance, detectable warning surfaces must be provided on all pedestrian curb ramps, medians and pedestrian refuge islands, railroad crossings and at grade sidewalk intersections with roadways.
- Curb ramps must contain a detectable warning surface that consists of raised truncated domes complying with ADA guidelines. The surface must contrast visually with adjoining surfaces, including side flares, in accordance with applicable sections of the Standard Specifications. Color for detectable warning surface shall be gray unless otherwise specified in the plans or by the project engineer.
- Detectable warning surfaces must be slip resistant and not allow water to accumulate.
- Align truncated domes in the direction of pedestrian travel when entering the street.
- Detectable warning surfaces shall be a minimum of 24" in depth in the direction of pedestrian travel and extend the full width of the throat of the curb ramp or landing where the pedestrian access route enters the street.
- Detectable warning surfaces shall be located so that the edge nearest the curb line is a minimum of 6" and maximum of 10" from the extension of the face of curb. Detectable warning surfaces may be curved along the corner radius. On flush median openings or depressed corners, truncated domes to be located along face of curb.
- Detectable warning surfaces (truncated domes) may be stamped, constructed of brick pavers or inlaid prefabricated mats attached by epoxy adhesive and mechanical attachment.
- For stamped applications, the detectable warning surface will be stamped and stained in accordance with manufacturer's recommendations. However, the following criteria shall be used for the concrete mix design in the overall construction of handicap ramps:
  - Average compressive strength: 4000 psi
  - Aggregate gradation: Type B pavement gradation
  - Minimum cement content: 600 pounds per cubic yard
  - Maximum water/cement ratio: 0.40
  - Total air content: 5% (+/- 2%)
  - Maximum slump: 6 inches
  - Curing: The exposed plain concrete (non-color stained concrete) surface should have a white pigment curing compound applied in such a manner that the surface and any exposed sides are evenly and uniformly covered to resemble a white sheet of paper. In no case should the application of curing compound be less than 1 gallon per 100 square feet.
- Any retrofit application must have beveled edges on the sides with approach pedestrian traffic.
- Where the ends of the bottom grade break are behind the back of curb and distance from either end of the bottom grade break to the back of curb is more than 5'-0", detectable warning surfaces shall be placed on the lower landing at the back of curb.

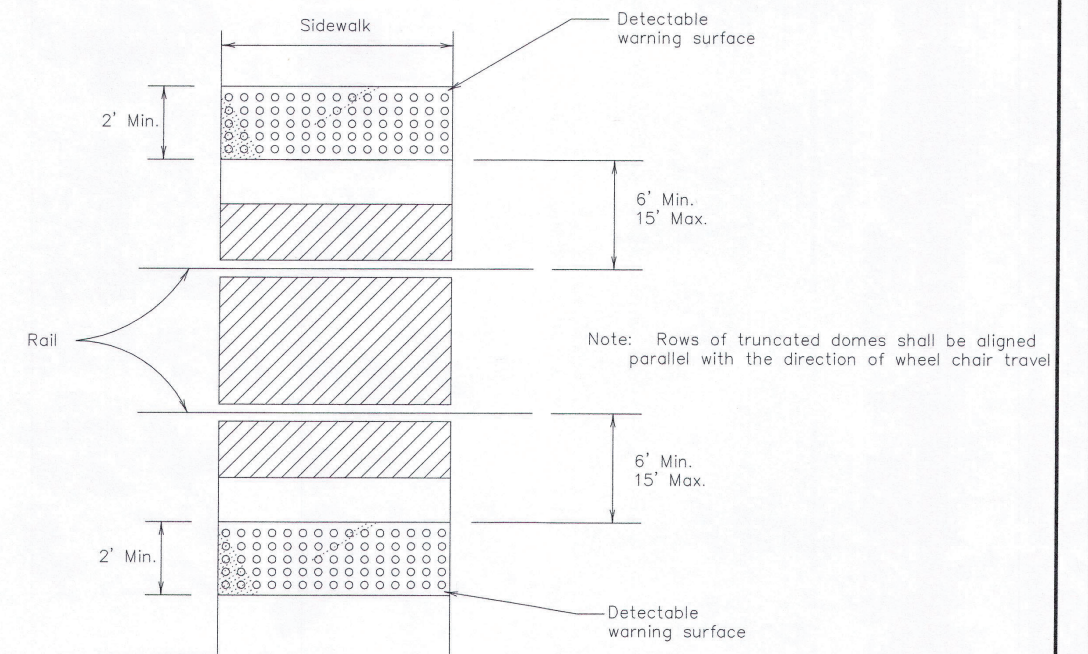

LOCATION OF DETECTABLE SURFACE AT RAILROAD CROSSINGS

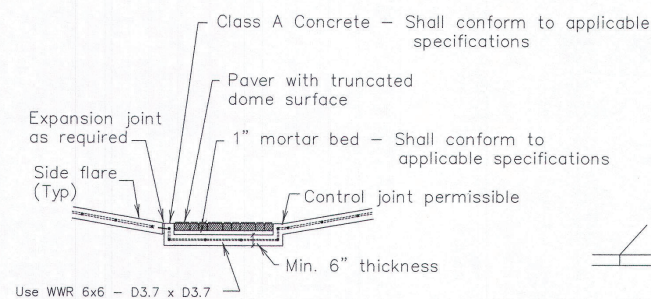

Section A-A

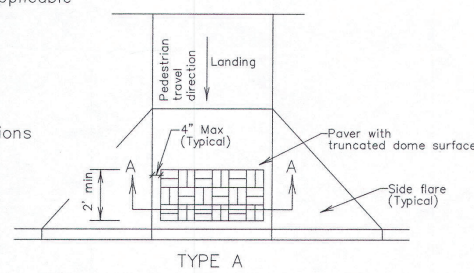

TYPE A  
Truncated Dome Pattern Curb Ramp  
DETECTABLE WARNINGS  
(Paver Option)

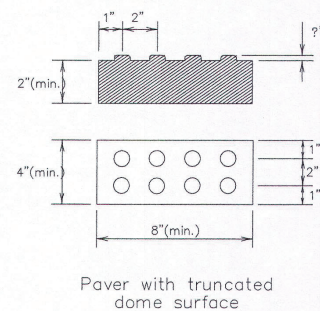

Paver with truncated dome surface

General Notes for Paver Option

Paver units shall meet all requirements of the applicable ASTM standards. Layout pattern shall be appropriate for size paver used. 4" x 8" pavers shall be laid out in a 2 x 2 basket weave pattern. 12" x 12" pavers shall be laid out in a block pattern.

Paver units shall have a truncated dome top surface for detectable warning to pedestrians.

Paver units shall be saw cut only and any cut unit shall not be less than 25 percent of a full unit.

Truncated Dome System shall be paid for in accordance with the applicable sections of the Standard Specifications.

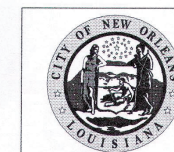

CITY OF NEW ORLEANS  
DEPARTMENT OF PUBLIC WORKS  
ENGINEERING DIVISION



CURB RAMP  
FOR  
STREET CONSTRUCTION

DRAWING No.

THESE DETAILS, WHILE DESIGNED IN ACCORDANCE WITH GENERALLY ACCEPTED ENGINEERING PRINCIPLES AND PRACTICES, IS THE SOLE RESPONSIBILITY OF THE USER AND SHOULD NOT BE USED WITHOUT CONSULTING A LOUISIANA REGISTERED PROFESSIONAL ENGINEER.

DATE: 2/3/2015  
SCALE: AS NOTED  
APPROVED: MARK D. JEROME, DIRECTOR

ADA4







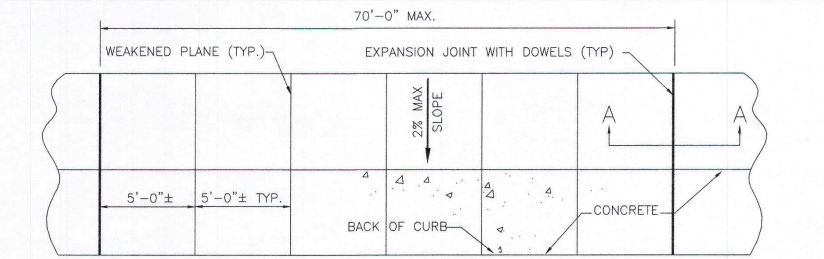

PLAN PORTLAND CEMENT CONCRETE SIDEWALK PAVEMENT (FULL)  
N.T.S.

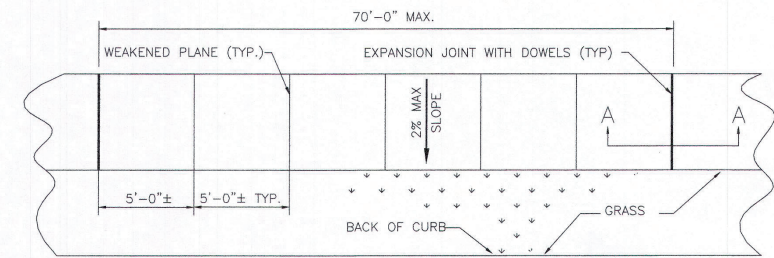

PLAN PORTLAND CEMENT CONCRETE SIDEWALK PAVEMENT (RIBBON)  
N.T.S.

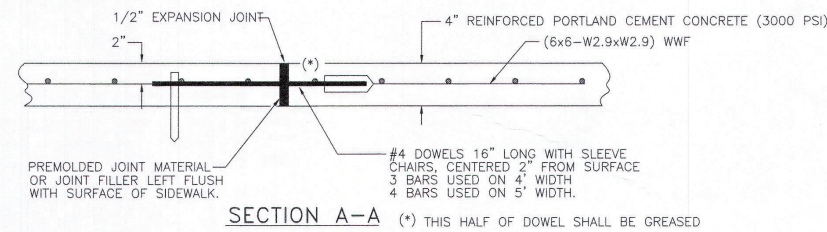

SECTION A-A (\*) THIS HALF OF DOWEL SHALL BE GREASED

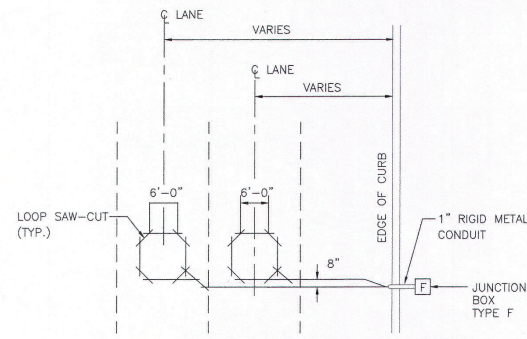

DOUBLE LANE

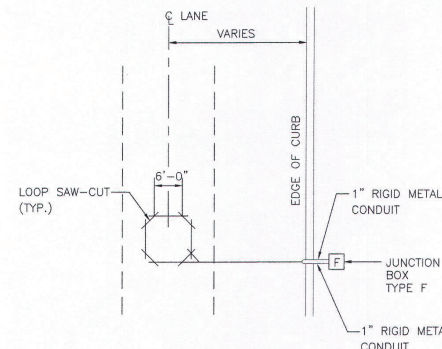

SINGLE LANE

NOTE:  
THE CONTRACTOR SHALL PROVIDE ONE INCH CONDUIT FROM JUNCTION BOX OR EQUIPMENT CABINET AND TERMINATE BELOW TOP OF PAVEMENT SO THAT IT DIRECTLY RECEIVES LOOP LEAD-IN WIRE.

TYPICAL LOOP SAW-CUT LAYOUT

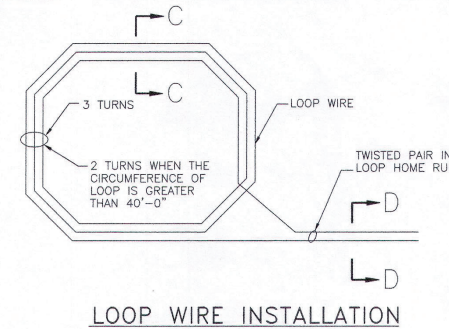

LOOP WIRE INSTALLATION

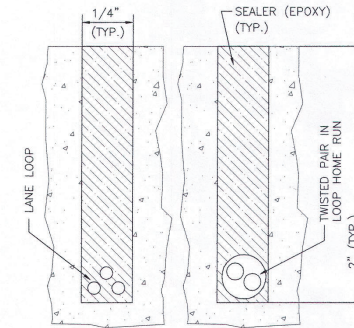

SECTION C-C SECTION D-D  
VEHICLE LOOP INSTALLATION

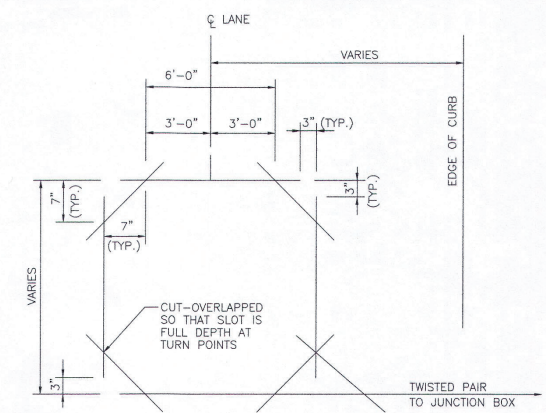

LOOP SAW-CUT CONFIGURATION

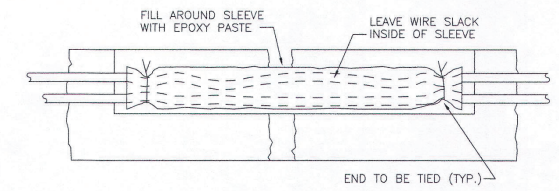

SECTION OF PLASTIC SLEEVING  
AT PAVEMENT JOINTS AND CRACKS

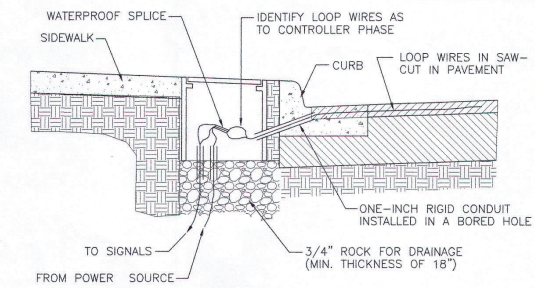

TYPICAL LOOP LEAD-IN INSTALLATION

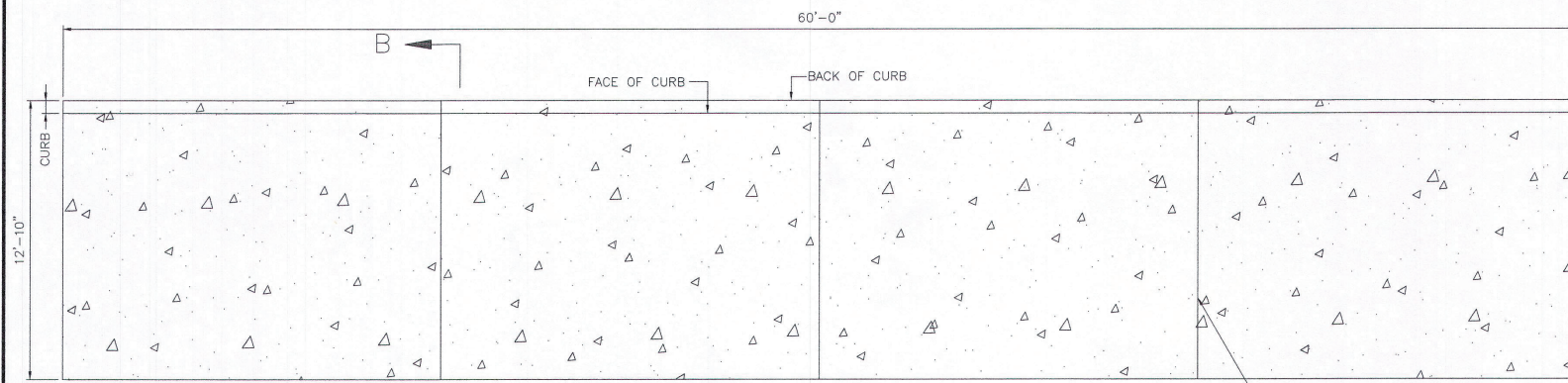

BUS PAD REPLACEMENT PLAN

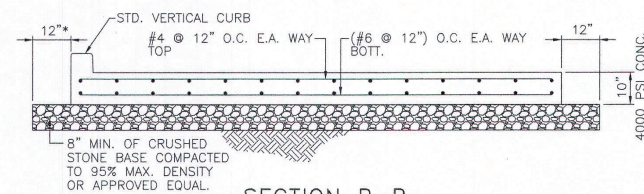

SECTION B-B

(\*) DELETE WITHIN DRIPLINE OF TREES

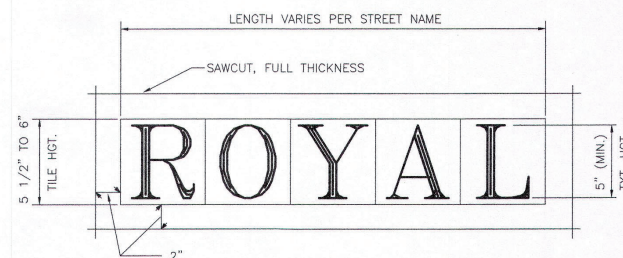

STREET NAME TILE  
N.T.S.

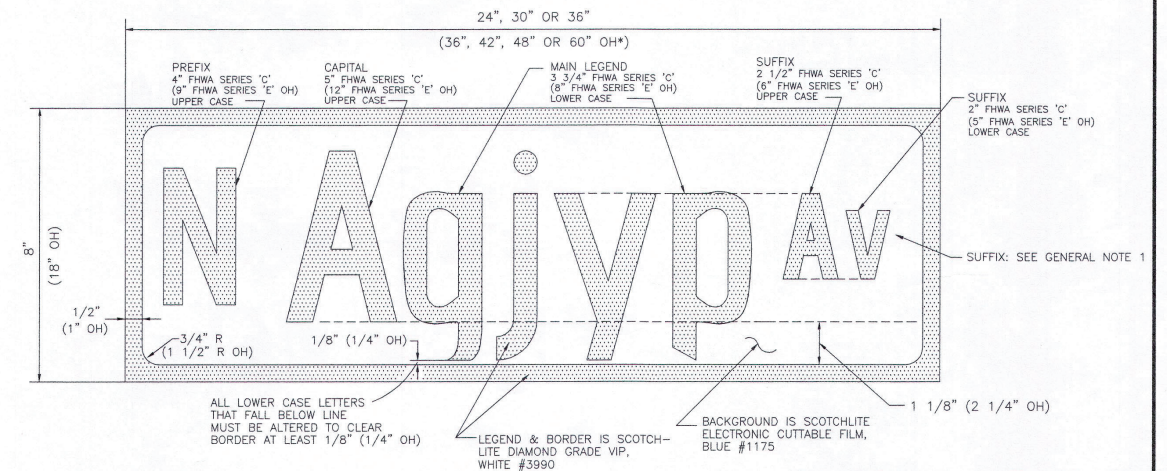

STREET NAME SIGN - LEGEND & BORDER

GENERAL NOTES:

- IF STREET NAME SUFFIX IS "STREET", SUFFIX IS OMITTED FROM SIGN.
- REPLACEMENT STREET NAME TILES SHALL BE SET IN A 1/4"-1/2" MORTAR BED WITH A 1/4" (MAX. SPACING) BETWEEN LETTERS.

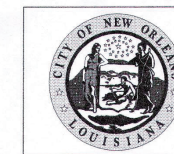

CITY OF NEW ORLEANS  
DEPARTMENT OF PUBLIC WORKS  
ENGINEERING DIVISION



MISCELLANEOUS DETAILS  
FOR  
STREET CONSTRUCTION

DRAWING No.

THE SELECTION AND USE OF THESE DETAILS, WHILE DESIGNED IN ACCORDANCE WITH GENERALLY ACCEPTED ENGINEERING PRINCIPLES AND PRACTICES, IS THE SOLE RESPONSIBILITY OF THE USER AND SHOULD NOT BE USED WITHOUT CONSULTING A LOUISIANA REGISTERED PROFESSIONAL ENGINEER.

DRAWN BY: N. SCHNEIDER  
REVIEWED BY: M.T. B.V. R.S. A.Y. L.H.  
RECOMMENDED BY: NGUYEN B. PHAN, CHIEF ENGINEER  
DATE: 2/3/2015  
SCALE: AS NOTED  
APPROVED: MARK D. JERNIGAN, DIRECTOR

MC1



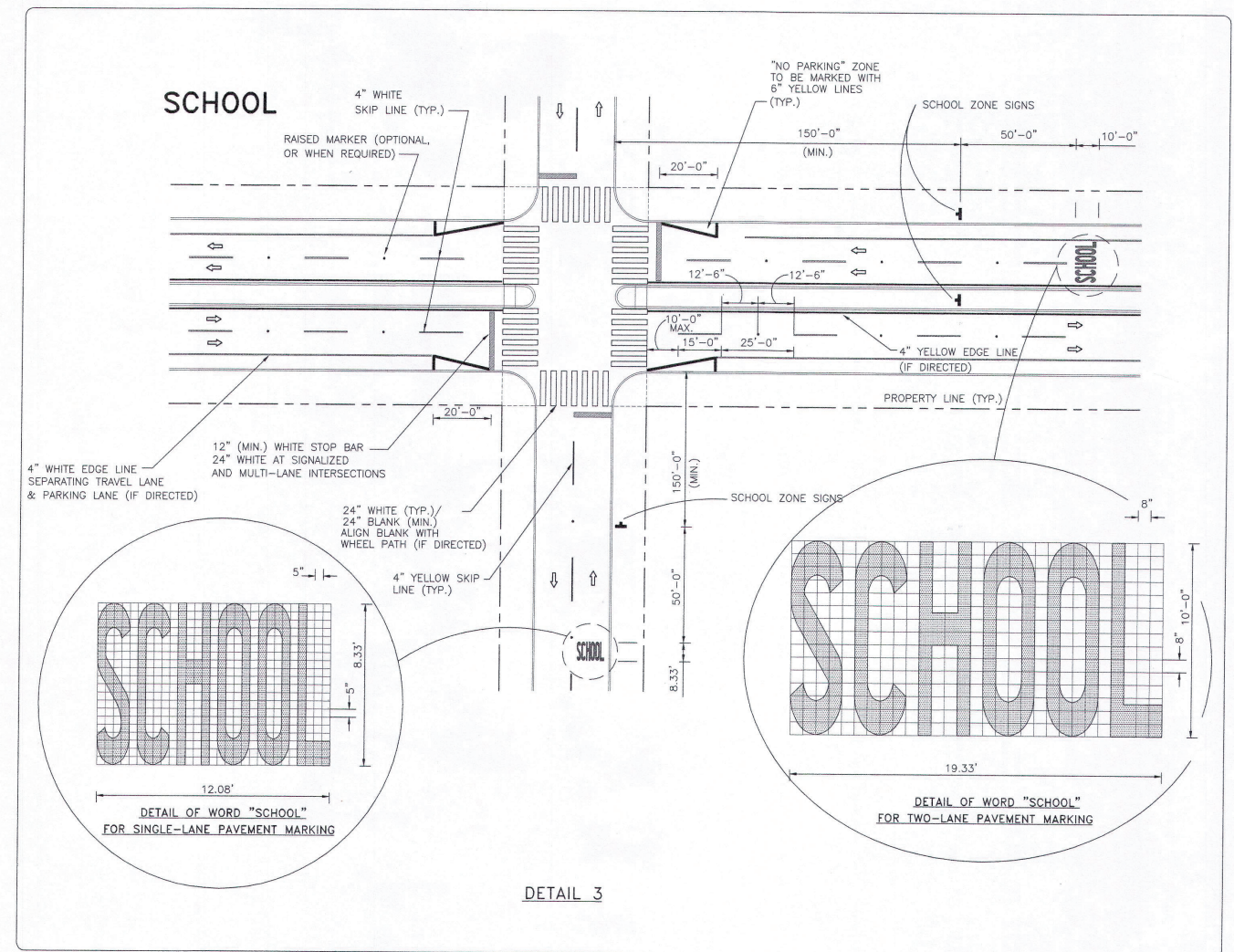
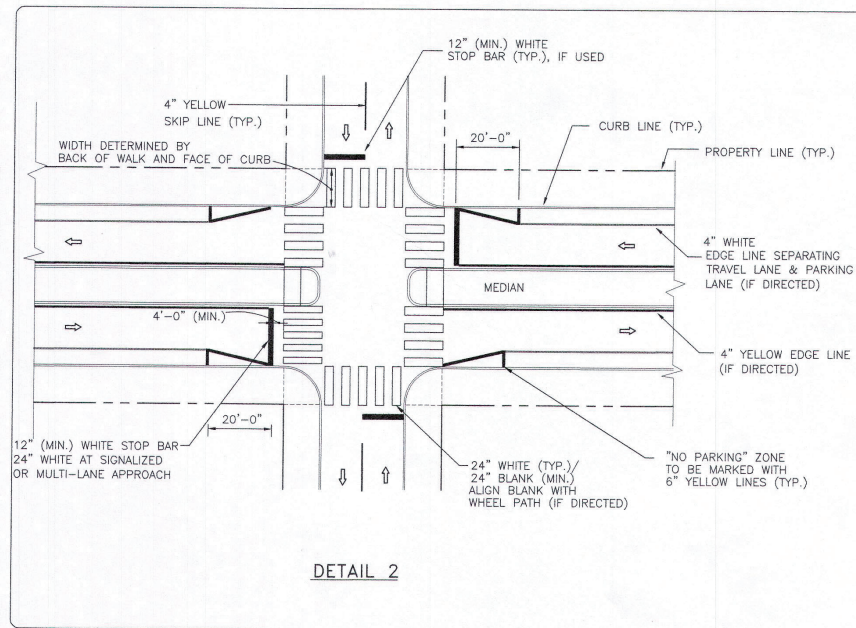
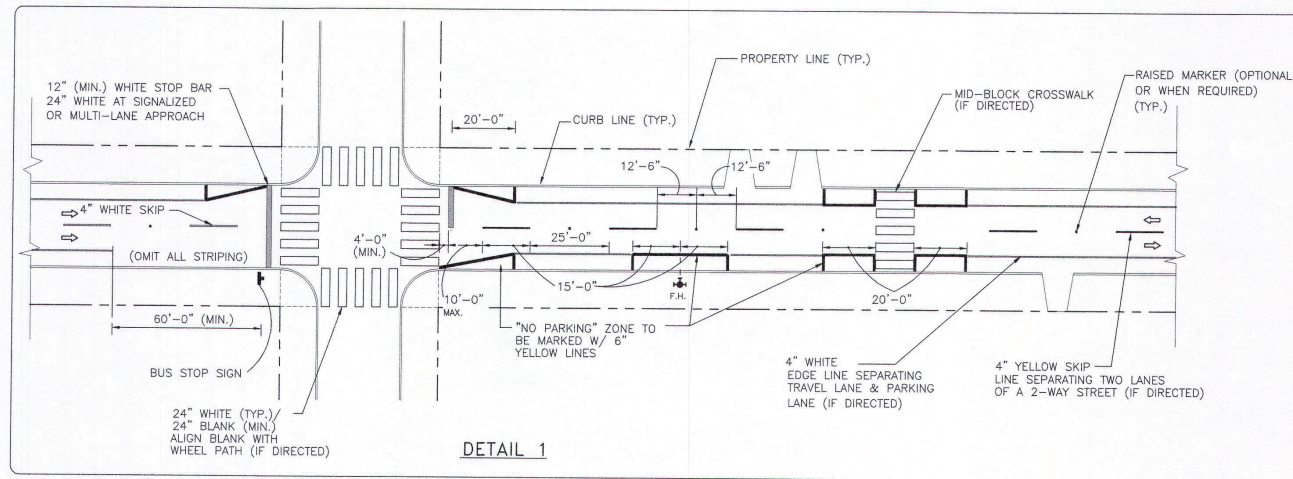

DESCRIPTION	COLOR	WIDTH	APPLICATION
SINGLE BROKEN	WHITE	4"	SEPARATION OF TRAVEL LANES IN THE SAME DIRECTION; INDICATE THAT IT IS PERMISSIBLE TO CROSS THE LINE TO CHANGE LANES; i. e., LANE LINES ON MULTILANE ROADWAYS.
	YELLOW	4"	SEPARATION OF TRAVEL LANES IN OPPOSITE DIRECTIONS; INDICATE THAT PASSING IS ALLOWED IN BOTH DIRECTIONS; i. e., CENTERLINE ON TWO LANE, TWO WAY ROADWAYS.
SINGLE SOLID	WHITE	4"	SEPARATION OF TRAVEL LANES OR SEPARATION OF TRAVEL LANE AND SHOULDER; INDICATE THAT CROSSING THE LINE IS DISCOURAGED; i. e., LANE LINES AT INTERSECTION APPROACHES OR RIGHT EDGE LINES.
		6"	SEPARATION OF A MOTOR VEHICLE TRAVEL LANE FROM A BIKE TRAVEL LANE.
	8"	DELINEATION OF LOCATION WHICH INDICATES CROSSING IS STRONGLY DISCOURAGED; i. e., SEPARATION OF TURN LANES FROM THROUGH LANES OR GORE AREAS AT RAMP TERMINALS.	
DOUBLE SOLID	YELLOW	4"	DELINEATION OF LEFT EDGE LINES ON DIVIDED ROADWAYS, ONE-WAY ROADS AND RAMP.
	WHITE	4"-4"-4"	SEPARATION OF TRAVEL LANES IN THE SAME DIRECTION; INDICATE THAT IT IS PROHIBITED TO CROSS THE LINES; e. g., PROHIBIT LANE CHANGES ON THE APPROACH TO AN OBSTRUCTION IN THE ROADWAY BETWEEN TWO LANES IN THE SAME DIRECTION.
DOUBLE SOLID	YELLOW	4"-4"-4"	SEPARATION OF TRAVEL LANES IN OPPOSITE DIRECTIONS, WHICH INDICATE THAT PASSING IS NOT ALLOWED IN EITHER DIRECTION. LEFT TURN MANEUVERS ACROSS THIS MARKING ARE PERMITTED. ALSO USED IN ADVANCE OF OBSTRUCTIONS WHICH MAY BE PASSED ONLY ON THE RIGHT SIDE.
		4"-2"-4"	SEPARATION OF TRAVEL LANES IN OPPOSITE DIRECTIONS; INDICATE THAT PASSING IS ALLOWED FOR VEHICLES ADJACENT TO THE BROKEN LINE, BUT PROHIBITED FOR VEHICLES ADJACENT TO SOLID LINE. USED ON TWO-WAY ROADWAYS WITH TWO OR THREE LANES. ALSO USED TO DELINEATE EDGES OF A TWO-WAY LEFT TURN LANES (SOLID ON THE OUTSIDE, BROKEN LINES ON THE INSIDE).
SOLID PLUS BROKEN	YELLOW	4"-2"-4"	SEPARATION OF TRAVEL LANES IN OPPOSITE DIRECTIONS; INDICATE THAT PASSING IS ALLOWED FOR VEHICLES ADJACENT TO THE BROKEN LINE, BUT PROHIBITED FOR VEHICLES ADJACENT TO SOLID LINE. USED ON TWO-WAY ROADWAYS WITH TWO OR THREE LANES. ALSO USED TO DELINEATE EDGES OF A TWO-WAY LEFT TURN LANES (SOLID ON THE OUTSIDE, BROKEN LINES ON THE INSIDE).
DOUBLE BROKEN	YELLOW	4"-4"-4"	DELINEATES THE EDGES OF REVERSIBLE LANES.
SINGLE DOTTED	BOTH	4"	AN EXTENSION OF A LANE LINE OR CENTERLINE THROUGH AN INTERSECTION OR A CURVED DOTTED LINE THROUGH AN INTERSECTION TO HELP GUIDE TURNING VEHICLES AS THEY MOVE THROUGH THEIR TURN. MAY EXTEND AN EDGELINE, ESPECIALLY WHERE THE ROAD WIDENS FOR AN ADDED LANE FOR DECELERATION OR FOR TURNING.
	WHITE	8"	SEPARATION OF THROUGH LANE AND AUXILIARY LANE OR DROPPED LANE.
TRANSVERSE	WHITE	6"	CROSSWALK EDGE LINES AT MINOR INTERSECTIONS, IF DIRECTED
		12"	STOP BARS AT MINOR INTERSECTIONS CROSSWALK EDGE LINES AT MAJOR INTERSECTIONS, IF DIRECTED
		24"	STOP BARS AT MAJOR INTERSECTIONS HIGH-VISIBILITY, LONGITUDINAL CROSSWALK STRIPING
DIAGONAL	WHITE	12"	CROSSHATCH MARKINGS, PLACED AT AN ANGLE OF 45° AT VARYING DISTANCES APART, ON SHOULDERS OR CHANNELIZATION ISLANDS TO ADD EMPHASIS TO THESE ROADWAY FEATURES.

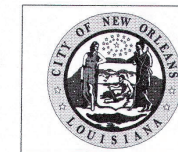
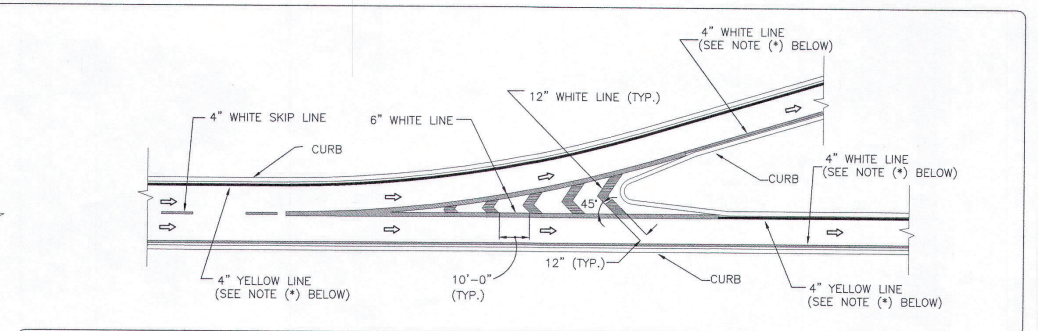
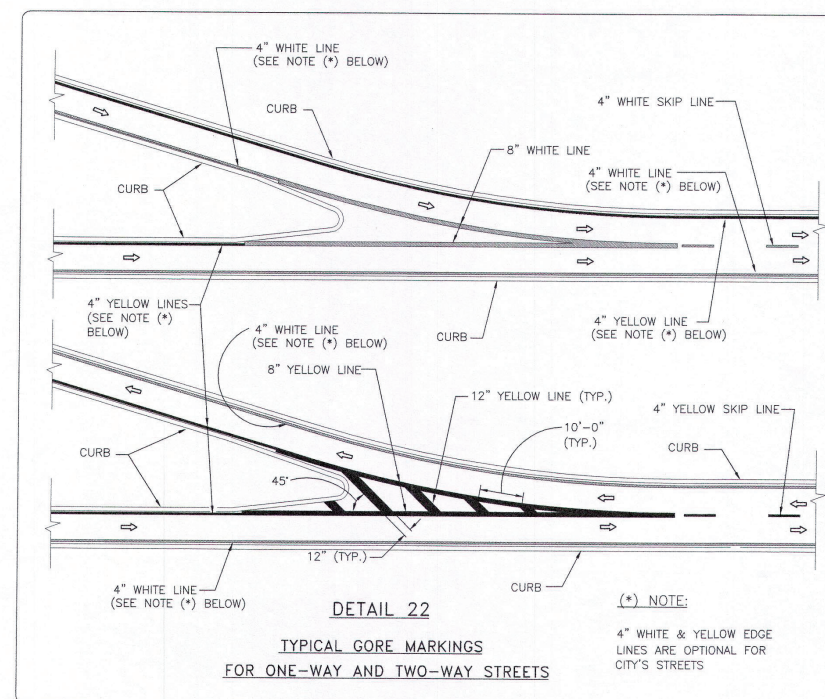

CITY OF NEW ORLEANS  
DEPARTMENT OF PUBLIC WORKS  
ENGINEERING DIVISION



TYPICAL APPLICATION  
OF  
PAVEMENT MARKINGS

DRAWING No.

THE SELECTION AND USE OF THESE DETAILS, WHILE DESIGNED IN ACCORDANCE WITH GENERALLY ACCEPTED ENGINEERING PRINCIPLES AND PRACTICES, IS THE SOLE RESPONSIBILITY OF THE USER AND SHOULD NOT BE USED WITHOUT CONSULTING A LOUISIANA REGISTERED PROFESSIONAL ENGINEER.

DRAWN BY: N. SCHNEIDER  
REVIEWED BY: A.Y. L.H.  
RECOMMENDED BY: NGUYEN D. PHAN, CHIEF ENGINEER  
DATE: 2/3/2015  
SCALE: AS NOTED  
APPROVED: MARK J. JERNIGAN, DIRECTOR

PM1



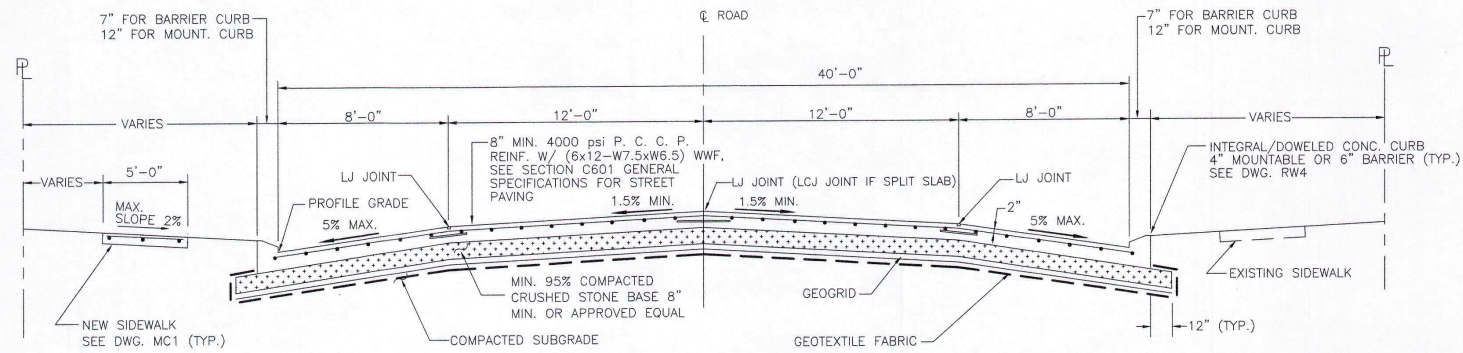

TYPICAL ROADWAY SECTION - 40'-0" RDWY. - P. C. C. P. (REINFORCED)

N.T.S.

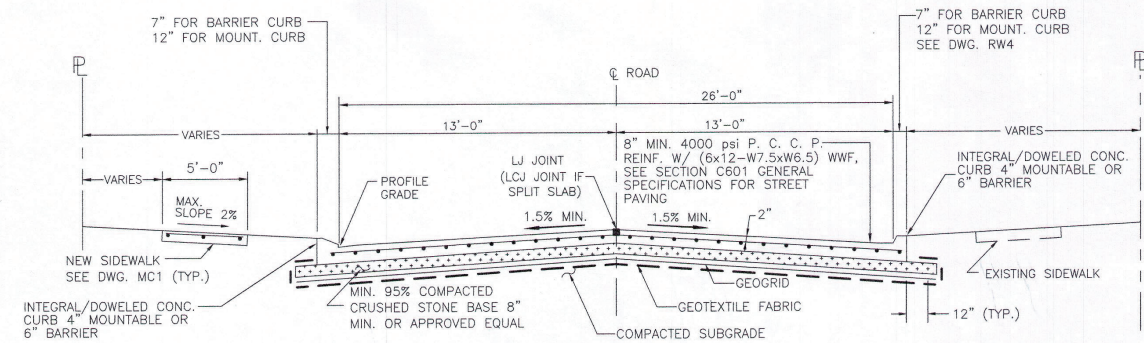

TYPICAL ROADWAY SECTION - 26'-0" RDWY. - P.C.C.P. (REINFORCED)

N.T.S.

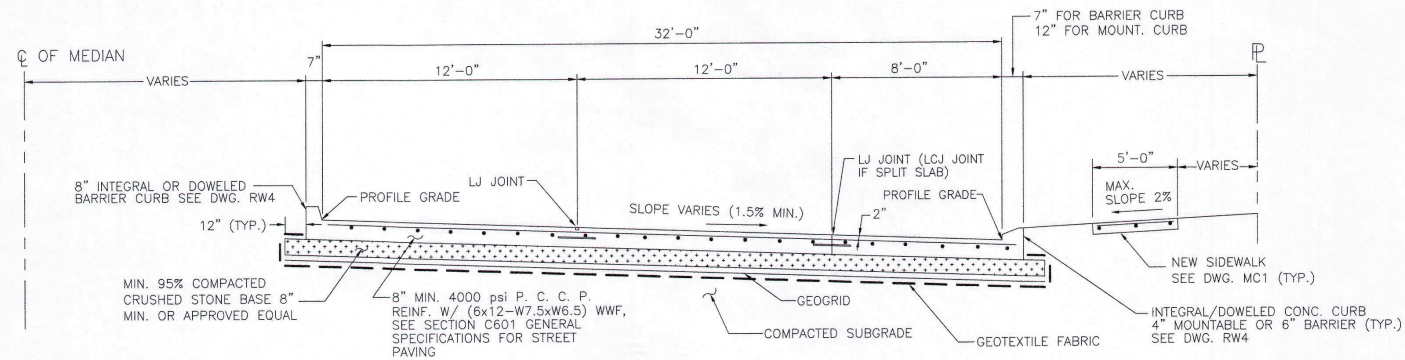

TYPICAL HALF SECTION - 32'-0" ROADWAY - P. C. C. P. (REINFORCED)

N.T.S.

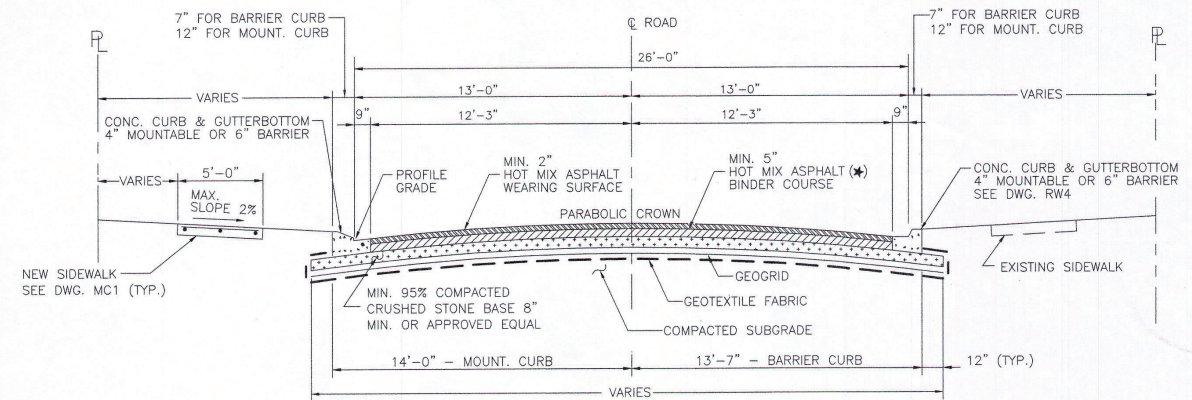

TYPICAL ROADWAY SECTION - 26'-0" RDWY. - ASPHALTIC CONCRETE PAVEMENT

MIN. THICKNESS = 7" TOTAL ASPHALTIC CONCRETE

N.T.S.

(\*) PROVIDE TACK COAT(S) BETWEEN ASPHALT LAYER(S)

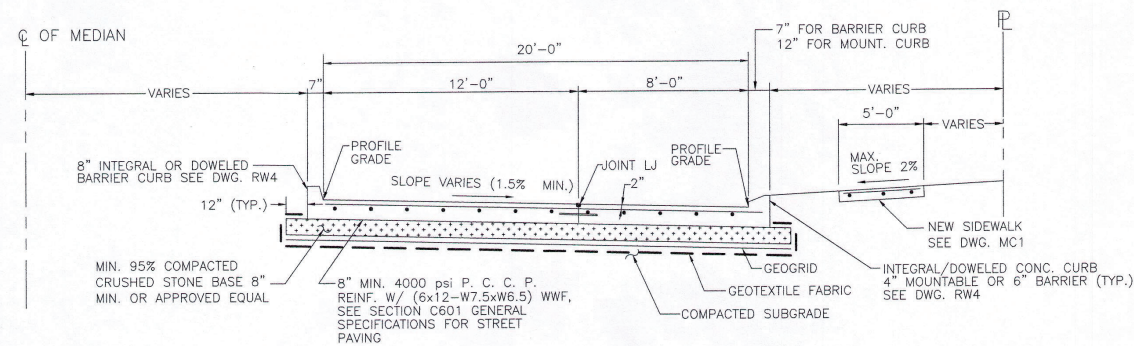

TYPICAL HALF SECTION - 20'-0" ROADWAY - P. C. C. P. (REINFORCED)

N.T.S.

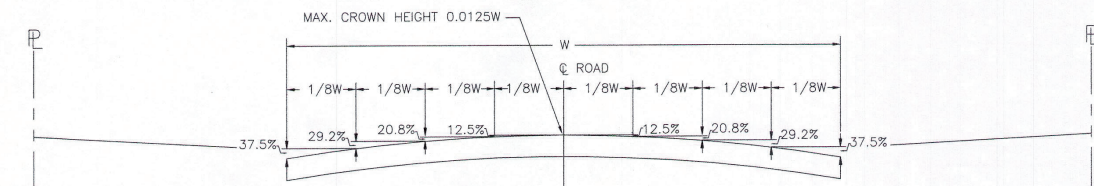

TYPICAL PARABOLIC CROWN - ASPHALTIC CONCRETE PAVEMENT

N.T.S.

GENERAL NOTES:

- (1) NEW SIDEWALK SHALL BE 4" REINFORCED PORTLAND CEMENT CONCRETE 3000 PSI. SIDEWALK SHALL BE 6" REINFORCED P.C.C. AT DRIVEWAYS.
- (2) NEW CURB AND GUTTERBOTTOM SHALL BE 4000 PSI REINFORCED PORTLAND CEMENT CONCRETE.
- (3) SEE DRAWINGS RW2 AND RW3 FOR JOINT DETAILS AND PLACEMENT.
- (4) ROADWAY MAXIMUM SLOPE MUST MEET AASHTO STANDARD.

	CITY OF NEW ORLEANS DEPARTMENT OF PUBLIC WORKS ENGINEERING DIVISION		
	TYPICAL ROADWAY SECTIONS FOR STREET CONSTRUCTION		
THE SELECTION AND USE OF THESE DETAILS, WHILE DESIGNED IN ACCORDANCE WITH GENERALLY ACCEPTED ENGINEERING PRINCIPLES AND PRACTICES, IS THE SOLE RESPONSIBILITY OF THE USER AND SHOULD NOT BE USED WITHOUT CONSULTING A LOUISIANA REGISTERED PROFESSIONAL ENGINEER.	DRAWN BY: N. SCHNEIDER	REVIEWED BY: M.T. B.V. R.S. B.J. A.Y.	RECOMMENDED BY: NGUYEN D. PHAN, CHIEF ENGINEER
DATE: 2/3/2015	SCALE: AS NOTED	APPROVED: MARI D. JERONIAN, DIRECTOR	



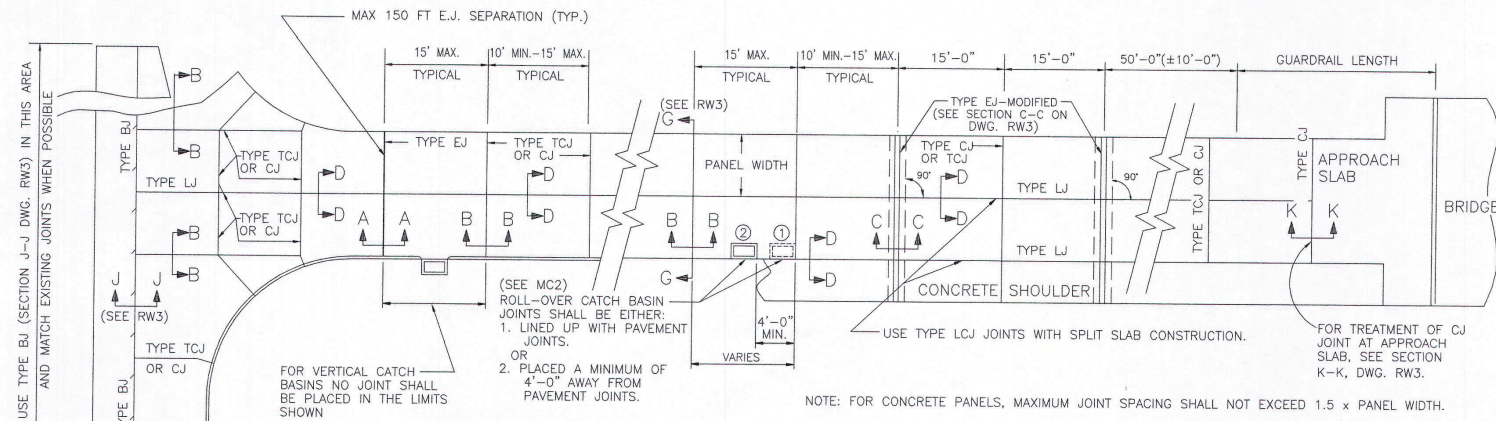

PLAN VIEW OF TYPICAL ROADWAY SHOWING JOINTS

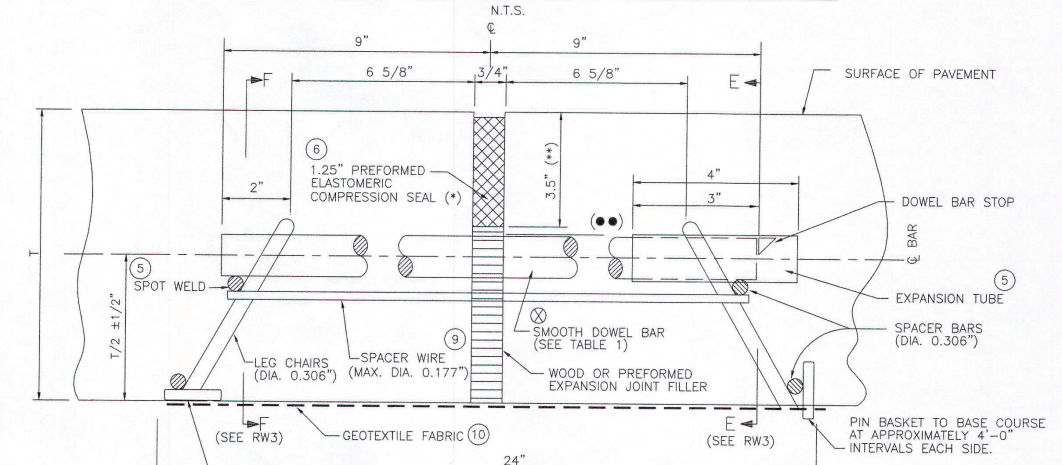

SECTION A-A  
TYPE EJ  
(TRANSVERSE EXPANSION JOINT)  
N.T.S.

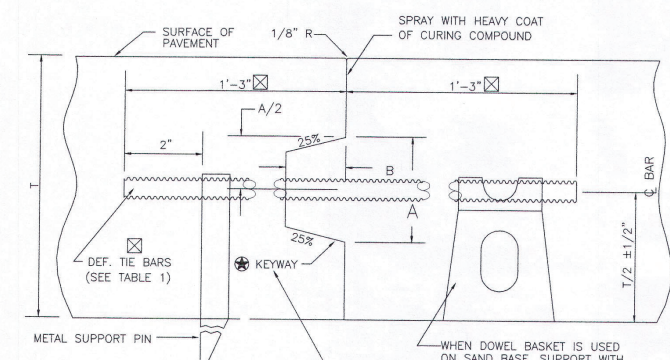

SECTION D-D  
TYPE LJ  
(LONGITUDINAL JOINT)  
(REQUIRED WHEN PAVEMENT WIDTH EXCEEDS 15')  
(SEE NOTE 7)

TABLE 1  
(ALL DIMENSIONS IN INCHES)

PAVEMENT THICKNESS T	SMOOTH DOWEL BARS			DEF. TIE BARS			MINIMUM DEPTH OF JOINT		KEYWAY	
	SIZE	LENGTH	SPACING	SIZE	LENGTH	SPACING	TCJ & CJ ±1/4"	LJ ±1/4"	A ±1/4"	B ±1/4"
7 OR LESS	1	18	12	1/2	24	24	2-1/2	2-1/2	ALLOW 7"	
8	1-1/4	18	12	1/2	24	24	3	3	2-1/2	1-1/4
9	1-1/4	18	12	1/2	24	24	3	3-1/2	2-1/2	1-1/4
10	1-1/2	18	12	1/2	24	24	3-1/2	4	2-1/2	1-1/4
11	1-1/2	18	12	5/8	30	24	3-1/2	4	2-1/2	1-1/4
12	1-1/2	18	12	5/8	30	24	4	4-1/2	3	1-1/2
13	1-1/2	18	12	5/8	30	24	4	4-1/2	3	1-1/2
14	1-1/2	18	12	5/8	30	24	4-1/2	5	3	1-1/2

⊗ FOR CONC. SHOULDERS, "T" IS THE THICKNESS AT PAVEMENT EDGE.

GENERAL STREET CONSTRUCTION NOTES:

- PAVEMENT EDGES SHALL BE SLIGHTLY ROUNDED TO APPROXIMATELY 1/4".
- ASPHALTIC CONCRETE JOINING P.C.C.P. OR ASPHALTIC CONCRETE SHOULDER: THE ASPHALT JOINT SHALL BE SAW CUT AND CONSTRUCTED IN ACCORDANCE WITH SECTION I-1, DRAWING RW3.
- FOR SECTIONS C-C, E-E, F-F, G-G, H-H, I-I, J-J, AND K-K SEE DRAWING RW3.
- ALL JOINTS ARE TO BE USED WHERE SHOWN ON THIS SHEET OR AS SHOWN ELSEWHERE IN THE PLANS OR AS OTHERWISE DIRECTED BY THE ENGINEER.
- ON TYPE EJ JOINTS, SPOT WELD ALTERNATE ENDS OF DOWEL BARS TO DOWEL BASKETS AND PLACE EXPANSION TUBES ON FREE ENDS OF DOWEL BARS, (SECTION A-A).
- TYPE EJ JOINTS SHALL BE SEALED WITH PREFORMED ELASTOMERIC COMPRESSION JOINT SEALS CONFORMING TO SUBSECTION 1005.03 OF DOTD "LOUISIANA STANDARD SPECIFICATIONS FOR ROADS AND BRIDGES", LATEST EDITION. THE SEALS SHALL HAVE A NOMINAL WIDTH OF 1-1/4" BEFORE COMPRESSION. JOINTS SHALL BE CLEANED PRIOR TO SEALING.
- FOR DESIGN SPEEDS OF 45 MPH OR GREATER:
  - TYPE LJ JOINTS SHALL BE SAW CUT AND CONSTRUCTED AS IN DETAIL "F" DRAWING RW3. THE JOINT SHALL BE SAW CUT AND CLEANED PRIOR TO SEALING WITH A JOINT SEALANT CONFORMING TO SUBSECTION 1005.02(b) OR (c) OF THE AFOREMENTIONED DOTD SPECIFICATIONS.
  - TYPE TCJ OR CJ SHALL BE SAW CUT AS SHOWN IN DETAIL "C" OR "D" DRAWING RW3 AND TO THE DEPTH SHOWN IN TABLE 1. THE JOINT SHALL BE SAND BLASTED AND CLEANED IMMEDIATELY PRIOR TO SEALING. THE INITIAL CUT SHALL BE MADE WITH 1/8" MINIMUM BLADE. THE SEALANT SHALL BE A PREFORMED ELASTOMERIC SEAL IN ACCORDANCE WITH SUBSECTION 1005.03 OR A SILICONE SEALANT IN ACCORDANCE WITH SUBSECTION 1005.02(c) OF THE AFOREMENTIONED DOTD SPECIFICATIONS.
- FOR DESIGN SPEEDS OF LESS THAN 45 MPH:
  - TYPE LJ JOINTS SHALL BE SAW CUT AS DESCRIBED IN 7(A).
  - TYPE TCJ OR CJ SHALL BE CONSTRUCTED AS FOLLOWS:
    - CONSTRUCTED AS DESCRIBED IN 7(B).
    - WITH A REMOVABLE FORMING DEVICE AS SHOWN IN DETAILS "A" AND "B" DRAWING RW3. THE JOINT SHALL BE SAND BLASTED AND CLEANED IMMEDIATELY PRIOR TO SEALING AND MAY REQUIRE SAWING TO ACHIEVE PROPER RESERVOIR DIMENSIONS.
    - WITH A COMBINATION JOINT FORMER/SEALER AS SHOWN IN DETAIL "E" DRAWING RW3. THE SEALER SHALL CONFORM TO SUBSECTION 1005.04 AND BE INSTALLED IN ACCORDANCE WITH SUBSECTION 601.09(c)(3) OF THE AFOREMENTIONED DOTD SPECIFICATIONS AND NO ADDITIONAL SEALANT IS REQUIRED.
- EXCEPT AS NOTED BELOW, DOWEL BARS & TIE BARS SHALL BE HELD IN PLACE BY SUPPORTS SIMILAR TO THE ONES SHOWN, OR APPROVED EQUALS. APPROVED MECHANICAL PLACEMENT OF DOWEL BARS AND TIE BARS WILL BE ALLOWED WITH ALL PAVING METHODS. WHEN DOWEL BAR BASKETS ARE USED, APPROXIMATELY THE CENTER 7" OF SPACER WIRES, THAT SPANS ACROSS THE JOINT, SHALL BE CLIPPED AND REMOVED AFTER STAKING BASKETS IN PLACE.
- INSTALL GEOTEXTILE FABRIC UNDER ALL TCJ, CJ, AND EJ JOINTS WHEN CONCRETE PAVEMENT IS PLACED ON UNSTABILIZED OR UNTREATED BASE COURSES OR SUBBASES. WHEN DOWEL BARS ARE MECHANICALLY IM-PLANTED, THE GEOTEXTILE FABRIC SHALL BE ANCHORED TO THE BASE COURSE WITH PINS.
- WHEN CONSTRUCTING CONCRETE CURB AND GUTTER ADJACENT TO NEW P.C.C. PAVEMENT, USE TYPE LCJ JOINT. WHEN ADJACENT TO EXISTING P.C.C. PAVEMENT, USE TYPE LBJ JOINT. THE FIRST LOAD TRANSFER DEVICE SHALL BE INSTALLED 18" FROM THE PAVEMENT EDGE.
- TRANSVERSE EXPANSION JOINTS SHALL NOT BE USED FOR CONSTRUCTION JOINTS.
- CONCRETE SHOULDERS:
  - CONSTRUCT TCJ JOINTS IN ACCORDANCE WITH SECTION B-B.
  - CONSTRUCT LCJ JOINTS IN ACCORDANCE WITH TYPE LCJ DETAIL ON THIS SHEET AND LJ JOINTS IN ACCORDANCE WITH SECTION D-D.
  - USE THE MAXIMUM SHOULDER THICKNESS WHEN DETERMINING DOWEL BAR AND TIE BAR SIZES IN TABLE 1.
  - WHEN SKEWED JOINTS ARE USED ON MAINLINE PAVING THE SHOULDER TCJ JOINTS MAY BE SKEWED OR CONSTRUCTED AT 90°.
  - SHOULDER JOINTS AND JOINT MATERIALS WILL MATCH THE MAINLINE.
  - HEIGHT OF DOWEL BASKETS WILL BE BASED ON THE SHOULDER THICKNESS. ALSO VARYING HEIGHT DOWEL BASKETS WILL BE ALLOWED.
- TIE BARS SHALL NOT BE PLACED WITHIN 18" OF CONTRACTION OR EXPANSION JOINTS.
- FOR REINFORCED STEEL, SEE DOTD SPECIFICATIONS SECTION 1009

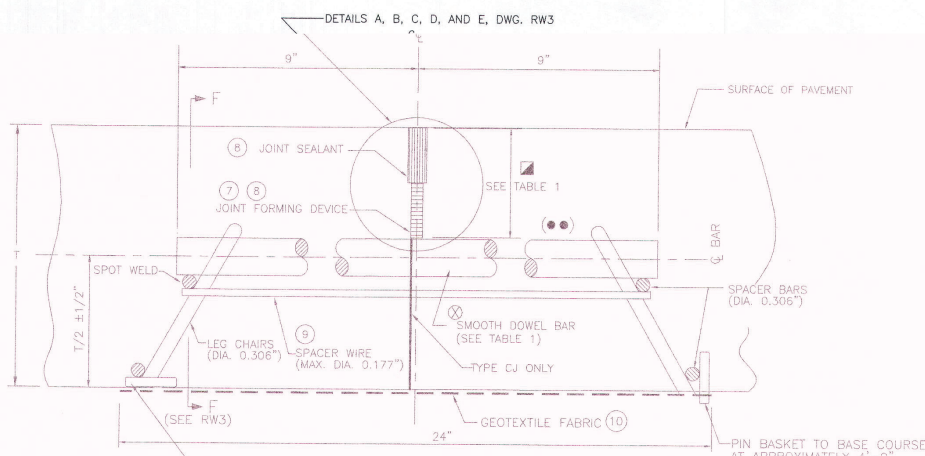

SECTION B-B  
TYPE TCJ OR CJ  
(TRANSVERSE CONTRACTION JOINT OR TRANSVERSE CONSTRUCTION JOINT)  
N.T.S.

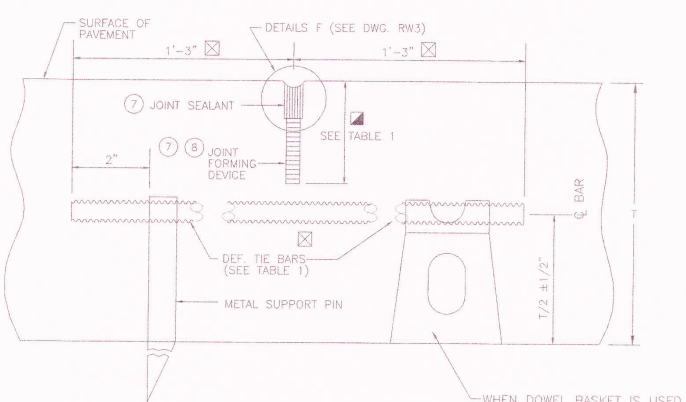

SECTION D-D  
TYPE LJ  
(LONGITUDINAL JOINT)  
(REQUIRED WHEN PAVEMENT WIDTH EXCEEDS 15')  
(SEE NOTE 7)

CITY OF NEW ORLEANS  
DEPARTMENT OF PUBLIC WORKS  
ENGINEERING DIVISION

DEPARTMENT OF PUBLIC WORKS  
ENGINEERING DIVISION

TYPICAL ROADWAY SECTIONS  
FOR  
STREET CONSTRUCTION

THE SELECTION AND USE OF THESE DETAILS, WHILE DESIGNED IN ACCORDANCE WITH GENERALLY ACCEPTED ENGINEERING PRINCIPLES AND PRACTICES, IS THE SOLE RESPONSIBILITY OF THE USER AND SHOULD NOT BE USED WITHOUT CONSULTING A LOUISIANA REGISTERED PROFESSIONAL ENGINEER.

DRAWN BY: N. SCHNEIDER  
REVIEWED BY: M.T. B.V. R.S. B.J. A.Y.  
DATE: 2/9/2015  
SCALE: AS NOTED

RECOMMENDED BY: NGUYEN D. THAI, CHIEF ENGINEER  
APPROVED: [Signature]  
MARK B. JEFFERS, DIRECTOR

DRAWING No.  
**RW2**



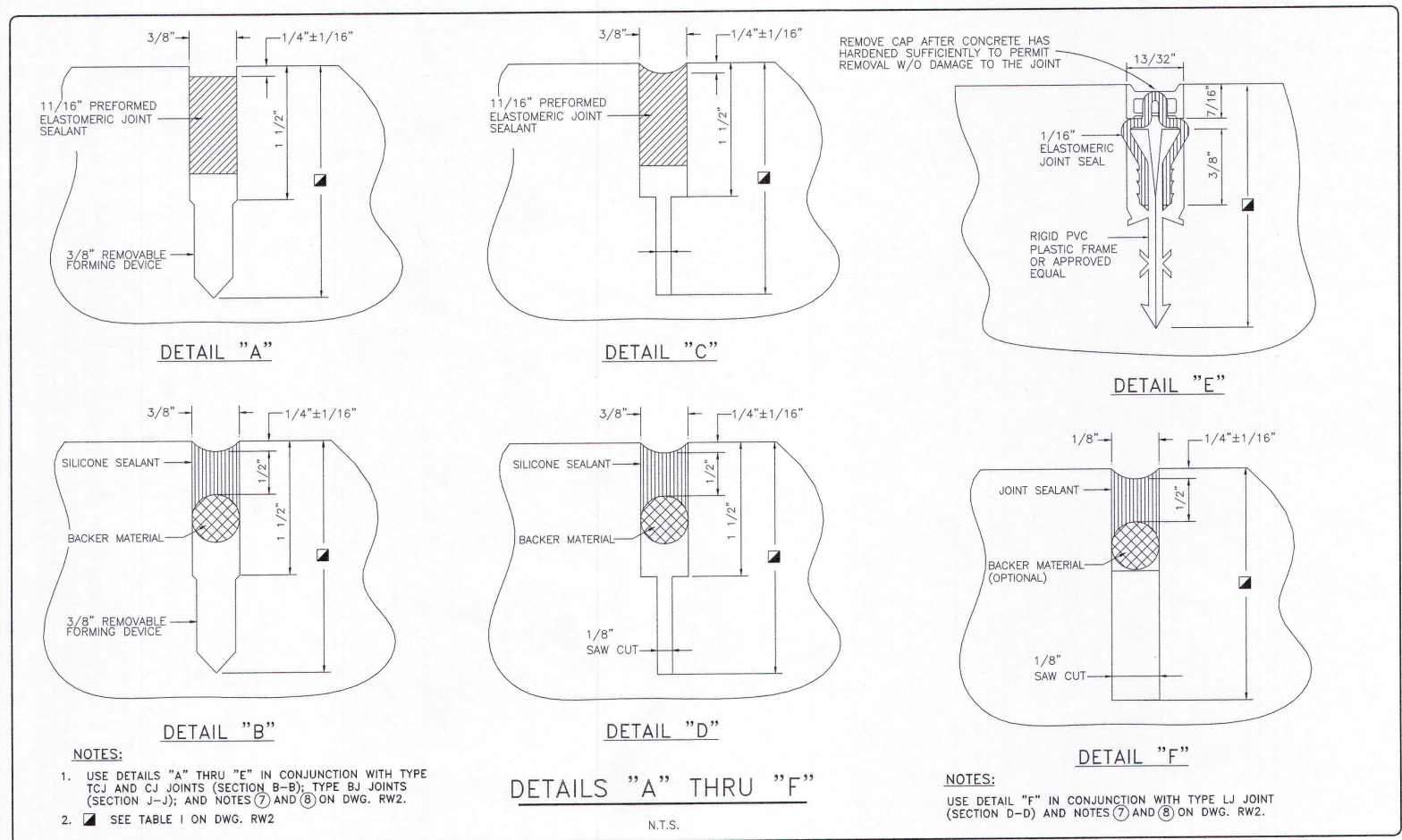

REMOVE CAP AFTER CONCRETE HAS HARDENED SUFFICIENTLY TO PERMIT REMOVAL W/O DAMAGE TO THE JOINT

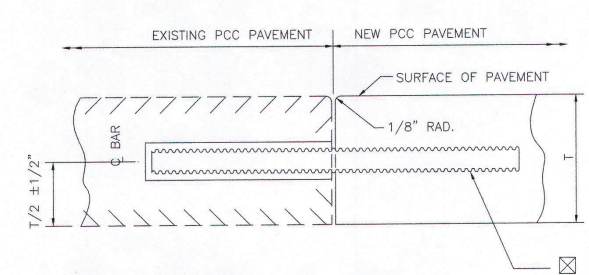

☒ DEFORMED TIE BARS SHALL BE INSTALLED IN EXISTING PAVEMENT BY DRILLING HOLES 1/8" LARGER, IF EPOXY IS USED OR 1/2" LARGER IF GROUT USED, THAN THE DIAMETER OF THE TIE BAR TO A REQUIRED DEPTH OF 1/2 BAR LENGTH. THE HOLES SHALL BE FILLED WITH AN APPROVED ADHESIVE ANCHOR SYSTEM (OPL 52) OR TYPE 1, GRADE C EPOXY RESIN BEFORE INSERTION OF THESE BARS. THE TIE BARS SIZE AND SPACING SHALL BE ONE OF THE FOLLOWING:

- A. WHEN TIE BARS OF THE SIZE SHOWN IN TABLE 1, DRAWINGS RW2, ARE USED, THE BARS SHALL BE PLACED AT 1/2 SPACING.
- B. WHEN TIE BARS 1/4" LARGER THAN TIE BAR DIAMETER SHOWN IN TABLE 1, ARE USED, THE BARS SHALL BE PLACED AT THE SAME SPACING.

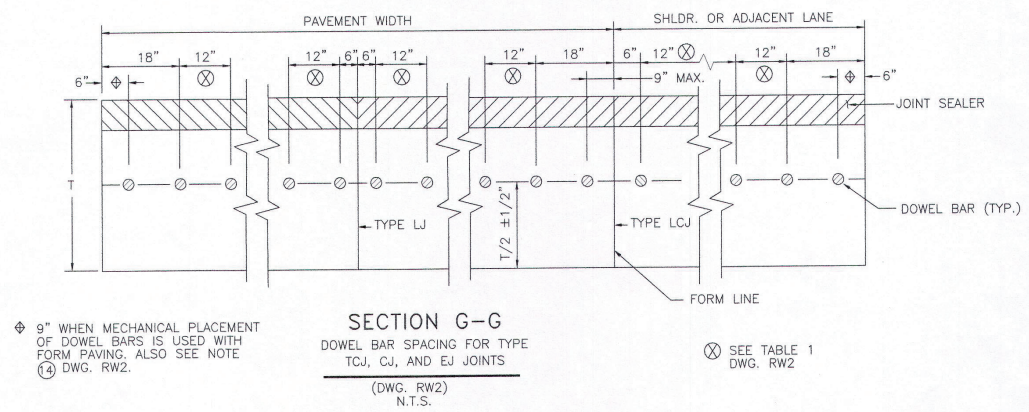
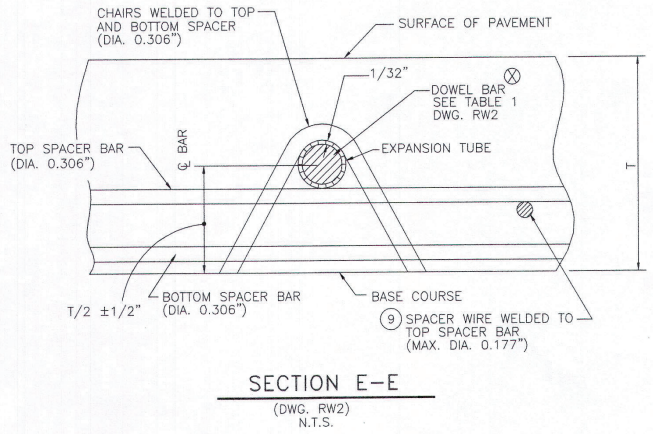
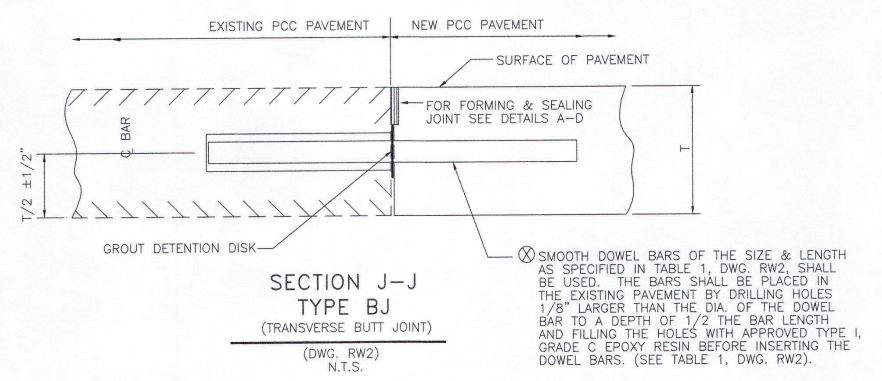
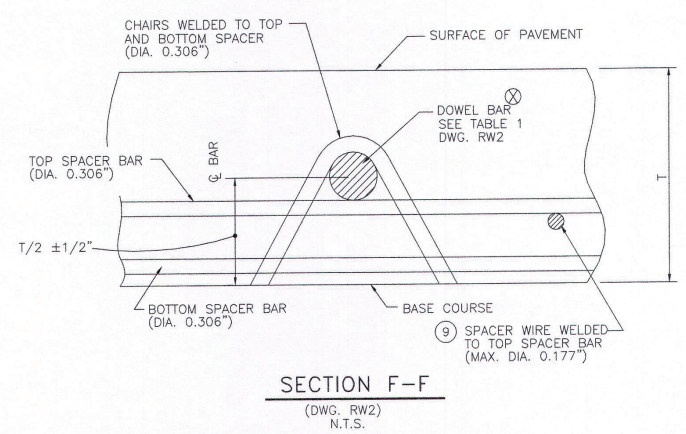
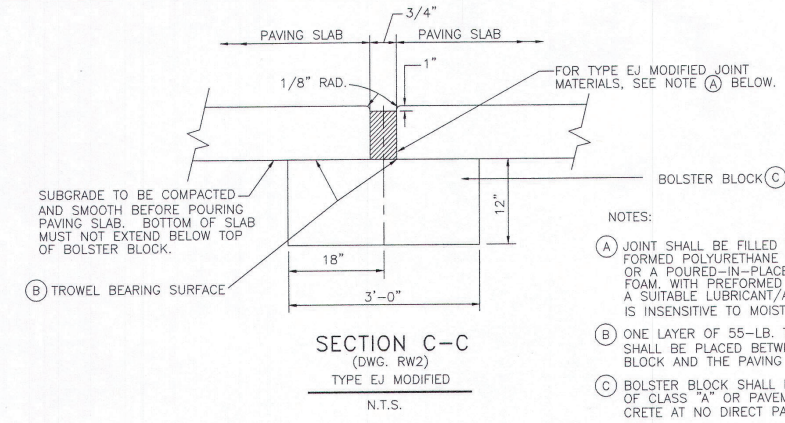
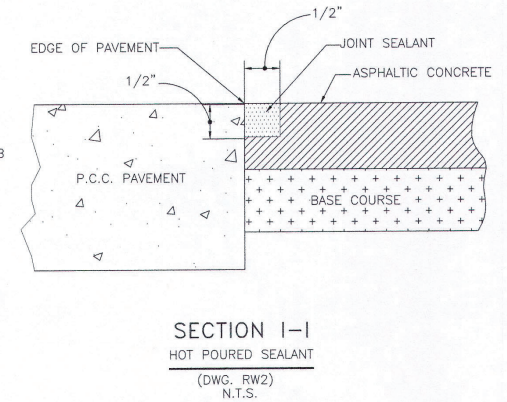
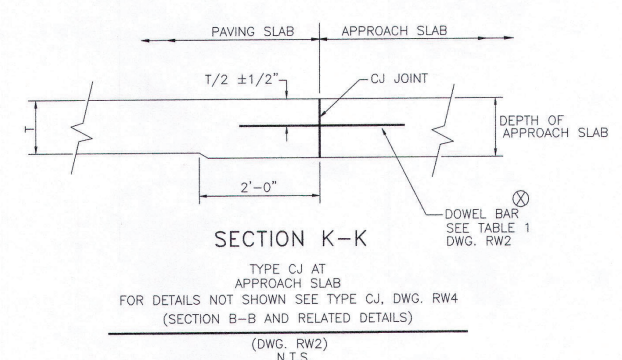

	CITY OF NEW ORLEANS DEPARTMENT OF PUBLIC WORKS ENGINEERING DIVISION		
	TYPICAL ROADWAY SECTIONS FOR STREET CONSTRUCTION		
THE SELECTION AND USE OF THESE DETAILS, WHILE DESIGNED IN ACCORDANCE WITH GENERALLY ACCEPTED ENGINEERING PRINCIPLES AND PRACTICES, IS THE SOLE RESPONSIBILITY OF THE USER AND SHOULD NOT BE USED WITHOUT CONSULTING A LOUISIANA REGISTERED PROFESSIONAL ENGINEER.	DRAWN BY: N. SCHNEIDER	REVIEWED BY: M.T. B.V. R.S. B.J. A.Y.	RECOMMENDED BY: NOLVEN D. PHAN, CHIEF ENGINEER
DATE: 2/3/2015	SCALE: AS NOTED	APPROVED: MARK D. JERNIGAN, DIRECTOR	



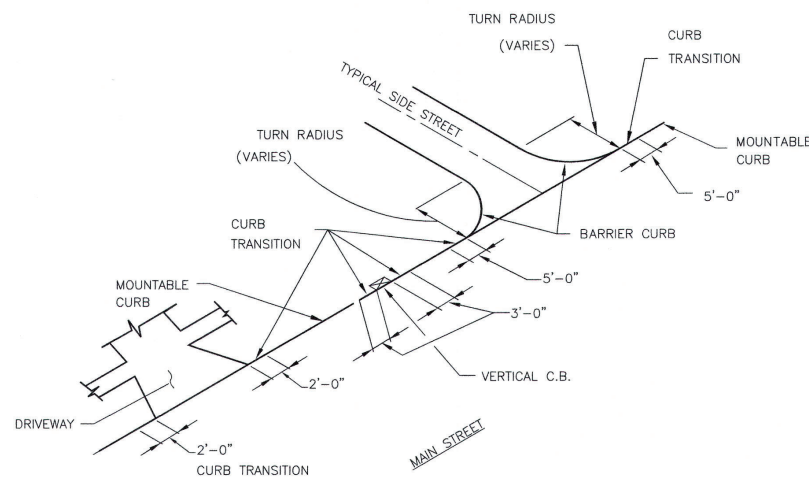

LOCATIONS OF CURB TRANSITION

N.T.S.

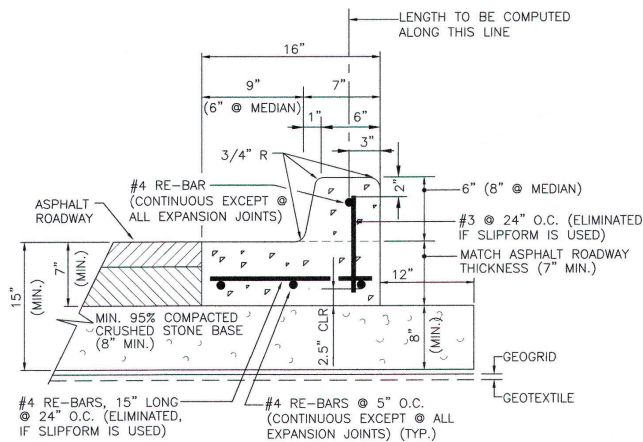

BARRIER CURB & GUTTERBOTTOM

N.T.S.

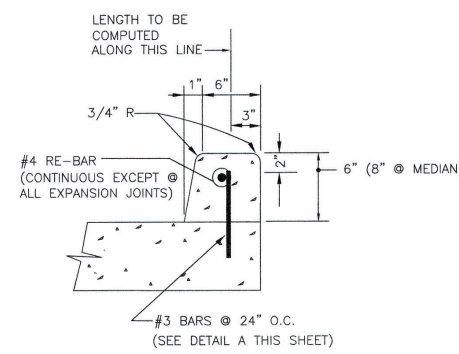

DOWELED BARRIER CURB

N.T.S.

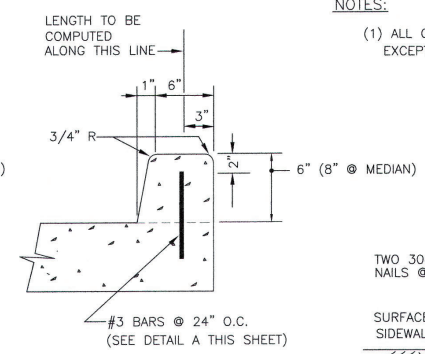

INTEGRAL BARRIER CURB

N.T.S.

NOTES:

(1) ALL CONCRETE GUTTERBOTTOM AND CURBS TO BE 4000 PSI EXCEPT AS OTHERWISE INDICATED.

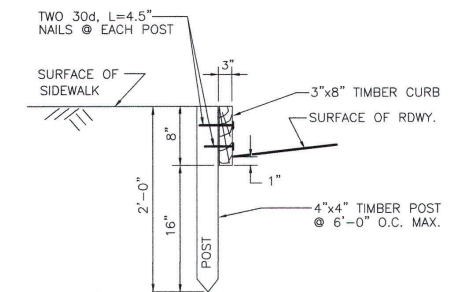

NOTE: TIMBER TO BE TREATED NO. 1 COMMON PINE (12 Lbs./Cf.)

TYPICAL SECTION OF TIMBER CURB

N.T.S.

WHEN SLIP-FORM SYSTEM IS USED THIS FACE TO BE TROWEL CUT TO A DEPTH OF 3" (APPROX.), THEN SCORED WITH A 1" SCORING TOOL AT 20'-0" MAX. INTERVALS OR TO MATCH ROADWAY JOINTS.

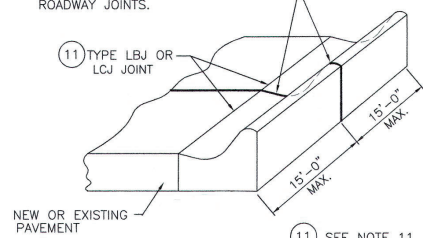

DETAIL SHOWING JOINTS IN CONCRETE CURB AND GUTTER

N.T.S.

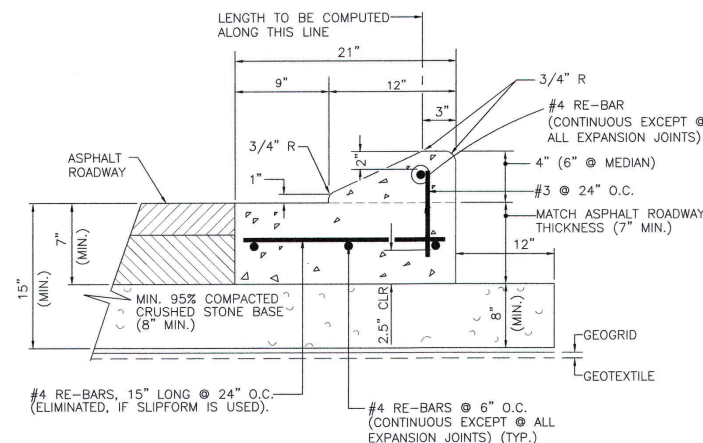

MOUNTABLE CURB & GUTTERBOTTOM

N.T.S.

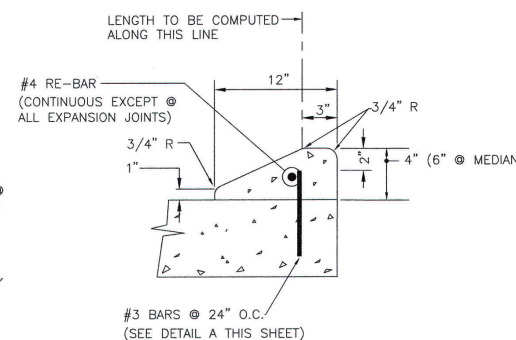

DOWELED MOUNTABLE CURB

N.T.S.

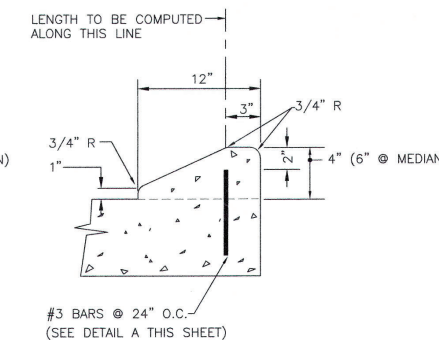

INTEGRAL MOUNTABLE CURB

N.T.S.

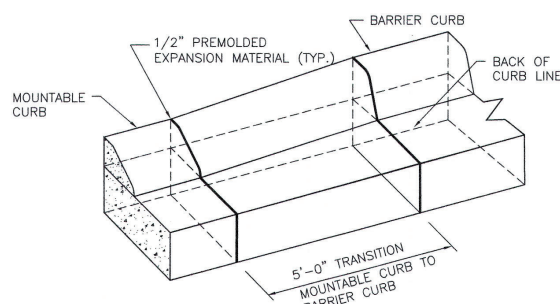

MOUNTABLE-BARRIER CURB TRANSITION

N. T. S.

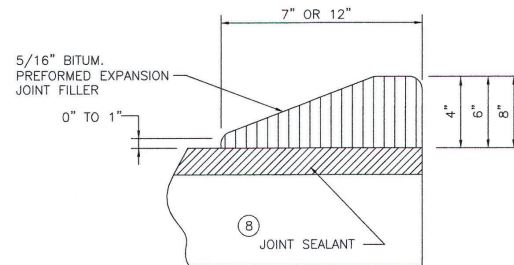

NOTE: WHEN CURB IS POURED MONOLITHICALLY WITH PAVEMENT, THE BITUMINOUS PREFORMED EXPANSION JOINT FILLER SHALL EXTEND TO BOTTOM OF JOINT INSERT.

(B) SEE NOTE 8 ON DWG RW2

JOINT FILLER DETAIL FOR INTEGRAL CONCRETE CURB (MOUNTABLE OR BARRIER TYPE)

(MOUNTABLE CURB IS SHOWN)  
N.T.S.

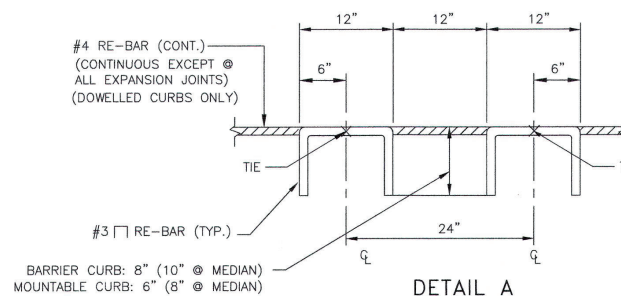

DETAIL A

SHOWING DIMENSIONS AND SPACING OF DEF. REINF. STEEL BARS FOR CONC. CURB  
N.T.S.

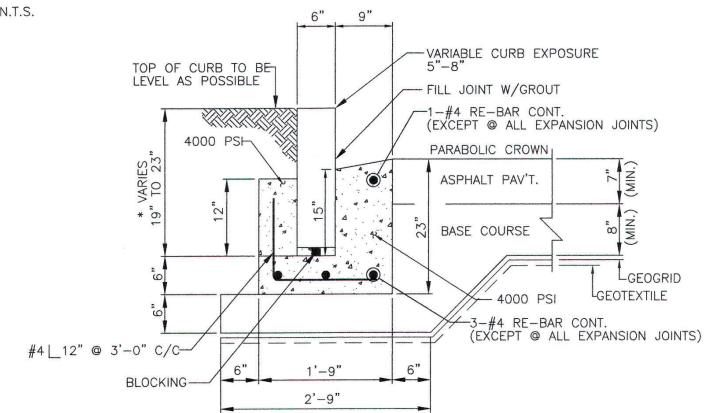

TYPICAL GRANITE BLOCK CURBING

\*APPROX. 19" TO 23" (ASSUME EXIST. GRANITE CURB IS 19" HIGH)  
N.T.S.

	CITY OF NEW ORLEANS DEPARTMENT OF PUBLIC WORKS ENGINEERING DIVISION		
	TYPICAL ROADWAY SECTIONS FOR STREET CONSTRUCTION		
THE SELECTION AND USE OF THESE DETAILS, WHILE DESIGNED IN ACCORDANCE WITH GENERALLY ACCEPTED ENGINEERING PRINCIPLES AND PRACTICES, IS THE SOLE RESPONSIBILITY OF THE USER AND SHOULD NOT BE USED WITHOUT CONSULTING A LOUISIANA REGISTERED PROFESSIONAL ENGINEER.	DRAWN BY: N. SCHNEIDER	REVIEWED BY: M.T. B.V. R.S. B.J. A.Y.	RECOMMENDED BY: [Signature] INDEPENDENT PROFESSIONAL ENGINEER
	DATE: 2/3/2015	SCALE: AS NOTED	APPROVED: [Signature] MARK D. JEROME, DIRECTOR
			DRAWING No. <b>RW4</b>

**"NO BID" RESPONSE FORM**

If you do not wish to bid/submit a bid on this solicitation, please provide written notification of your decision. Your responses assist with planning future solicitations. Please indicate below in the appropriate area the reason(s) for your decision and return this page. Responses do not prohibit you from receiving future opportunities unless you request to be removed from future communications. This form may be returned to the address listed below, emailed to [pmarquette@hano.org](mailto:pmarquette@hano.org), or faxed to 504-286-8224.

**Check all that apply:**

- I am submitting a "No Bid" at this time.

**Please keep my name on the Agency's Bidder's List.**

- Too busy at this time
- Job too small
- Job too large
- Territory too large to cover
- Cannot meet delivery requirements
- I cannot meet the Terms and Conditions of the solicitation because:
- I do not provide products/services of this nature.
- Insufficient time to respond to solicitation
- Unable to meet bond/insurance requirements
- Specifications too restrictive. Please explain:

\_\_\_\_\_

- Specifications unclear. Please explain:

\_\_\_\_\_

- Other: \_\_\_\_\_

- Please remove my name from this product/service category. I wish to submit a revised Vendor Registration Form. You may receive a copy by email by contacting Procurement at [pmarquette@hano.org](mailto:pmarquette@hano.org).

- I no longer wish to do business with Housing Authority of New Orleans. Please remove my name from the Agency's Source List(s).

\_\_\_\_\_  
Name of Company

\_\_\_\_\_  
Date

\_\_\_\_\_  
Printed Name of Authorized Representative

\_\_\_\_\_  
Phone Number

\_\_\_\_\_  
Signature of Authorized Representative

\_\_\_\_\_  
Email

Please return this completed form to:  
**Housing Authority of New Orleans**  
Procurement & Contracts Department  
4100 Touro St.  
New Orleans, LA 70122  
Email: [pmarquette@hano.org](mailto:pmarquette@hano.org) Fax: 504-286-8224



# IFB Attachment A (Form of Bid)



FORM OF BID

**(ATTACHMENT A)**

(This Form must be fully completed and included in the “hard copy” as a required bid submittal.)

Instructions: Unless otherwise specifically required, the items listed below must be completed and included in the bid submittal. Please complete this form by marking an “X,” where provided, to verify that the referenced completed form or information has been included within the “hard copy” bid submittal submitted by the bidder. Also, complete the Section 3 Statement and the Bidder’s Statement as noted below:

X=ITEM INCLUDED	SUBMITTAL ITEMS <i>(One original and Three copies of each bid, including one with original signatures)</i>
_____	1 Form of Bid (Attachment A)
_____	2 Form HUD-5369-A (Attachment E)
_____	3 Form SF-LLL (Disclosure of Lobbying Activities (Attachment B-1)
_____	4 Form HUD-50071 (Certification of Payments to Influence Federal Transactions (Attachment B-2)
_____	5 Form HUD-50070 - (Certification of a Drug-Free Workplace (Attachment B-3)
_____	6 Profile of Firm Form (Attachment C)
_____	7 Entry of Proposed Fees (Louisiana Uniform Public Work Bid Form (Attachment I)
_____	8 Acknowledgment of Addenda
_____	9 Equal Employment Opportunity Statement/Supplier Diversity
_____	10 Certification of Contractor Non-Exclusion
_____	11 Subcontractor/Joint Venture Information-If no Subs, you <u>MUST</u> include a statement indicating you will not use Sub-Contractors.
_____	12 Section 3 Business Preference Documentation
_____	13 Statement of Bidder’s Qualifications (Attachment Q)
_____	14 Vendor Registration Form (Attachment L)
_____	15 Corporate Resolution (Attachment R)
_____	16 Core List of Employees
_____	17 Bid Bond, no less than 5% of base bid amount
_____	18 Company’s Equal Opportunity Statement (EEO Statement on Company Letterhead)

**SECTION 3 STATEMENT**

Are you claiming a Section 3 business preference? YES\_or NO\_. If “YES,” pursuant to the Section 3 portion within the Conditions and Specifications, and pursuant to the documentation justifying such, which priority are you claiming?\_\_\_\_\_.

**BIDDER’S STATEMENT**

The undersigned bidder hereby states that by completing and submitting this Form and all other documents within this bid submittal, he/she is verifying that all information provided herein is, to the best of his/her knowledge, true and accurate, and that if the HA discovers that any information entered herein to be false, such shall entitle the HA to not consider or make award or to cancel any award with the undersigned party. Further, by completing and submitting the bid submittal, and by entering and submitting the costs where provided within the noted Internet System, the undersigned bidder is thereby agreeing to abide by all terms and conditions pertaining to this IFB as issued by the HA, either in hard copy or on the noted Internet System, including an agreement to execute the attached Sample Contract form. Pursuant to all IFB Documents, this Form of Bid, and all attachments, and pursuant to all completed Documents submitted, including these forms and all attachments, the undersigned proposes to supply the HA with the services described herein for the fee(s) entered within the areas provided within the noted Internet System pertaining to this IFB.

\_\_\_\_\_  
Signature                                      Date                                      Printed Name                                      Company

# Attachment B

## HUD-5369



**U.S. Department of Housing and  
Urban Development**  
Office of Public and Indian Housing

**Instructions to Bidders for Contracts  
Public and Indian Housing Programs**



# Instructions to Bidders for Contracts

## Public and Indian Housing Programs

### Table of Contents

Clause	Page
1. Bid Preparation and Submission	1
2. Explanations and Interpretations to Prospective Bidders	1
3. Amendments to Invitations for Bids	1
4. Responsibility of Prospective Contractor	1
5. Late Submissions, Modifications, and Withdrawal of Bids	1
6. Bid Opening	2
7. Service of Protest	2
8. Contract Award	2
9. Bid Guarantee	3
10. Assurance of Completion	3
11. Preconstruction Conference	3
12. Indian Preference Requirements	3

### 1. Bid Preparation and Submission

(a) Bidders are expected to examine the specifications, drawings, all instructions, and, if applicable, the construction site (see also the contract clause entitled **Site Investigation and Conditions Affecting the Work** of the *General Conditions of the Contract for Construction*). Failure to do so will be at the bidders' risk.

(b) All bids must be submitted on the forms provided by the Public Housing Agency/Indian Housing Authority (PHA/IHA). Bidders shall furnish all the information required by the solicitation. Bids must be signed and the bidder's name typed or printed on the bid sheet and each continuation sheet which requires the entry of information by the bidder. Erasures or other changes must be initialed by the person signing the bid. Bids signed by an agent shall be accompanied by evidence of that agent's authority. (Bidders should retain a copy of their bid for their records.)

(c) Bidders must submit as part of their bid a completed form HUD-5369-A, "Representations, Certifications, and Other Statements of Bidders."

(d) All bid documents shall be sealed in an envelope which shall be clearly marked with the words "Bid Documents," the Invitation for Bids (IFB) number, any project or other identifying number, the bidder's name, and the date and time for receipt of bids.

(e) If this solicitation requires bidding on all items, failure to do so will disqualify the bid. If bidding on all items is not required, bidders should insert the words "No Bid" in the space provided for any item on which no price is submitted.

(f) Unless expressly authorized elsewhere in this solicitation, alternate bids will not be considered.

(g) Unless expressly authorized elsewhere in this solicitation, bids submitted by telegraph or facsimile (fax) machines will not be considered.

(h) If the proposed contract is for a Mutual Help project (as described in 24 CFR Part 905, Subpart E) that involves Mutual Help contributions of work, material, or equipment, supplemental information regarding the bid advertisement is provided as an attachment to this solicitation.

### 2. Explanations and Interpretations to Prospective Bidders

(a) Any prospective bidder desiring an explanation or interpretation of the solicitation, specifications, drawings, etc., must request it at least 7 days before the scheduled time for bid opening. Requests may be oral or written. Oral requests must be confirmed in writing. The only oral clarifications that will be provided will be those clearly related to solicitation procedures, i.e., not substantive technical information. No other oral explanation or interpretation will be provided. Any information given a prospective bidder concerning this solicitation will be furnished promptly to all other prospective bidders as a written amendment to the solicitation, if that information is necessary in submitting bids, or if the lack of it would be prejudicial to other prospective bidders.

(b) Any information obtained by, or provided to, a bidder other than by formal amendment to the solicitation shall not constitute a change to the solicitation.

### 3. Amendments to Invitations for Bids

(a) If this solicitation is amended, then all terms and conditions which are not modified remain unchanged.

(b) Bidders shall acknowledge receipt of any amendment to this solicitation (1) by signing and returning the amendment, (2) by identifying the amendment number and date on the bid form, or (3) by letter, telegram, or facsimile, if those methods are authorized in the solicitation. The PHA/IHA must receive acknowledgement by the time and at the place specified for receipt of bids. Bids which fail to acknowledge the bidder's receipt of any amendment will result in the rejection of the bid if the amendment(s) contained information which substantively changed the PHA's/IHA's requirements.

(c) Amendments will be on file in the offices of the PHA/IHA and the Architect at least 7 days before bid opening.

### 4. Responsibility of Prospective Contractor

(a) The PHA/IHA will award contracts only to responsible prospective contractors who have the ability to perform successfully under the terms and conditions of the proposed contract. In determining the responsibility of a bidder, the PHA/IHA will consider such matters as the bidder's:

- (1) Integrity;
- (2) Compliance with public policy;
- (3) Record of past performance; and
- (4) Financial and technical resources (including construction and technical equipment).

(b) Before a bid is considered for award, the bidder may be requested by the PHA/IHA to submit a statement or other documentation regarding any of the items in paragraph (a) above. Failure by the bidder to provide such additional information shall render the bidder nonresponsible and ineligible for award.

## 5. Late Submissions, Modifications, and Withdrawal of Bids

(a) Any bid received at the place designated in the solicitation after the exact time specified for receipt will not be considered unless it is received before award is made and it:

(1) Was sent by registered or certified mail not later than the fifth calendar day before the date specified for receipt of offers (e.g., an offer submitted in response to a solicitation requiring receipt of offers by the 20th of the month must have been mailed by the 15th);

(2) Was sent by mail, or if authorized by the solicitation, was sent by telegram or via facsimile, and it is determined by the PHA/IHA that the late receipt was due solely to mishandling by the PHA/IHA after receipt at the PHA/IHA; or

(3) Was sent by U.S. Postal Service Express Mail Next Day Service - Post Office to Addressee, not later than 5:00 p.m. at the place of mailing two working days prior to the date specified for receipt of proposals. The term "working days" excludes weekends and observed holidays.

(b) Any modification or withdrawal of a bid is subject to the same conditions as in paragraph (a) of this provision.

(c) The only acceptable evidence to establish the date of mailing of a late bid, modification, or withdrawal sent either by registered or certified mail is the U.S. or Canadian Postal Service postmark both on the envelope or wrapper and on the original receipt from the U.S. or Canadian Postal Service. Both postmarks must show a legible date or the bid, modification, or withdrawal shall be processed as if mailed late. "Postmark" means a printed, stamped, or otherwise placed impression (exclusive of a postage meter machine impression) that is readily identifiable without further action as having been supplied and affixed by employees of the U.S. or Canadian Postal Service on the date of mailing. Therefore, bidders should request the postal clerk to place a hand cancellation bull's-eye postmark on both the receipt and the envelope or wrapper.

(d) The only acceptable evidence to establish the time of receipt at the PHA/IHA is the time/date stamp of PHA/IHA on the proposal wrapper or other documentary evidence of receipt maintained by the PHA/IHA.

(e) The only acceptable evidence to establish the date of mailing of a late bid, modification, or withdrawal sent by Express Mail Next Day Service-Post Office to Addressee is the date entered by the post office receiving clerk on the "Express Mail Next Day Service-Post Office to Addressee" label and the postmark on both the envelope or wrapper and on the original receipt from the U.S. Postal Service. "Postmark" has the same meaning as defined in paragraph (c) of this provision, excluding postmarks of the Canadian Postal Service. Therefore, bidders should request the postal clerk to place a legible hand cancellation bull's eye postmark on both the receipt and Failure by a bidder to acknowledge receipt of the envelope or wrapper.

(f) Notwithstanding paragraph (a) of this provision, a late modification of an otherwise successful bid that makes its terms more favorable to the PHA/IHA will be considered at any time it is received and may be accepted.

(g) Bids may be withdrawn by written notice, or if authorized by this solicitation, by telegram (including mailgram) or facsimile machine transmission received at any time before the exact time set for opening of bids; provided that written confirmation of telegraphic or facsimile withdrawals over the signature of the bidder is mailed and postmarked prior to the specified bid opening time. A bid may be withdrawn in person by a bidder or its authorized representative if, before the exact time set for opening of bids, the identity of the person requesting withdrawal is established and the person signs a receipt for the bid.

## 6. Bid Opening

All bids received by the date and time of receipt specified in the solicitation will be publicly opened and read. The time and place of opening will be as specified in the solicitation. Bidders and other interested persons may be present.

## 7. Service of Protest

(a) Definitions. As used in this provision:

"Interested party" means an actual or prospective bidder whose direct economic interest would be affected by the award of the contract.

"Protest" means a written objection by an interested party to this solicitation or to a proposed or actual award of a contract pursuant to this solicitation.

(b) Protests shall be served on the Contracting Officer by obtaining written and dated acknowledgement from —

[Contracting Officer designate the official or location where a protest may be served on the Contracting Officer]

(c) All protests shall be resolved in accordance with the PHA's/IHA's protest policy and procedures, copies of which are maintained at the PHA/IHA.

## 8. Contract Award

(a) The PHA/IHA will evaluate bids in response to this solicitation without discussions and will award a contract to the responsible bidder whose bid, conforming to the solicitation, will be most advantageous to the PHA/IHA considering only price and any price-related factors specified in the solicitation.

(b) If the apparent low bid received in response to this solicitation exceeds the PHA's/IHA's available funding for the proposed contract work, the PHA/IHA may either accept separately priced items (see 8(e) below) or use the following procedure to determine contract award. The PHA/IHA shall apply in turn to each bid (proceeding in order from the apparent low bid to the high bid) each of the separately priced bid deductible items, if any, in their priority order set forth in this solicitation. If upon the application of the first deductible item to all initial bids, a new low bid is within the PHA's/IHA's available funding, then award shall be made to that bidder. If no bid is within the available funding amount, then the PHA/IHA shall apply the second deductible item. The PHA/IHA shall continue this process until an evaluated low bid, if any, is within the PHA's/IHA's available funding. If upon the application of all deductibles, no bid is within the PHA's/IHA's available funding, or if the solicitation does not request separately priced deductibles, the PHA/IHA shall follow its written policy and procedures in making any award under this solicitation.

(c) In the case of tie low bids, award shall be made in accordance with the PHA's/IHA's written policy and procedures.

(d) The PHA/IHA may reject any and all bids, accept other than the lowest bid (e.g., the apparent low bid is unreasonably low), and waive informalities or minor irregularities in bids received, in accordance with the PHA's/IHA's written policy and procedures.

(e) Unless precluded elsewhere in the solicitation, the PHA/IHA may accept any item or combination of items bid.

(f) The PHA/IHA may reject any bid as nonresponsive if it is materially unbalanced as to the prices for the various items of work to be performed. A bid is materially unbalanced when it is based on prices significantly less than cost for some work and prices which are significantly overstated for other work.

(g) A written award shall be furnished to the successful bidder within the period for acceptance specified in the bid and shall result in a binding contract without further action by either party.

#### **9. Bid Guarantee (applicable to construction and equipment contracts exceeding \$25,000)**

All bids must be accompanied by a negotiable bid guarantee which shall not be less than five percent (5%) of the amount of the bid. The bid guarantee may be a certified check, bank draft, U.S. Government Bonds at par value, or a bid bond secured by a surety company acceptable to the U.S. Government and authorized to do business in the state where the work is to be performed. In the case where the work under the contract will be performed on an Indian reservation area, the bid guarantee may also be an irrevocable Letter of Credit (see provision 10, Assurance of Completion, below). Certified checks and bank drafts must be made payable to the order of the PHA/IHA. The bid guarantee shall insure the execution of the contract and the furnishing of a method of assurance of completion by the successful bidder as required by the solicitation. Failure to submit a bid guarantee with the bid shall result in the rejection of the bid. Bid guarantees submitted by unsuccessful bidders will be returned as soon as practicable after bid opening.

#### **10. Assurance of Completion**

(a) Unless otherwise provided in State law, the successful bidder shall furnish an assurance of completion prior to the execution of any contract under this solicitation. This assurance may be [Contracting Officer check applicable items] —

[ ] (1) a performance and payment bond in a penal sum of 100 percent of the contract price; or, as may be required or permitted by State law;

[ ] (2) separate performance and payment bonds, each for 50 percent or more of the contract price;

[ ] (3) a 20 percent cash escrow;

[ ] (4) a 25 percent irrevocable letter of credit; or,

[ ] (5) an irrevocable letter of credit for 10 percent of the total contract price with a monitoring and disbursements agreement with the IHA (applicable only to contracts awarded by an IHA under the Indian Housing Program).

(b) Bonds must be obtained from guarantee or surety companies acceptable to the U.S. Government and authorized to do business in the state where the work is to be performed. Individual sureties will not be considered. U.S. Treasury Circular Number 570, published annually in the Federal Register, lists companies approved to act as sureties on bonds securing Government contracts, the maximum underwriting limits on each contract bonded, and the States in which the company is licensed to do business. Use of companies listed in this circular is mandatory. Copies of the circular may be downloaded on the U.S. Department of Treasury website <http://www.fms.treas.gov/c570/index.html>, or ordered for a minimum fee by contacting the Government Printing Office at (202) 512-2168.

(c) Each bond shall clearly state the rate of premium and the total amount of premium charged. The current power of attorney for the person who signs for the surety company must be attached to the bond. The effective date of the power of attorney shall not precede the date of the bond. The effective date of the bond shall be on or after the execution date of the contract.

(d) Failure by the successful bidder to obtain the required assurance of completion within the time specified, or within such extended period as the PHA/IHA may grant based upon reasons determined adequate by the PHA/IHA, shall render the bidder ineligible for award. The PHA/IHA may then either award the contract to the next lowest responsible bidder or solicit new bids. The PHA/IHA may retain the ineligible bidder's bid guarantee.

#### **11. Preconstruction Conference (applicable to construction contracts)**

After award of a contract under this solicitation and prior to the start of work, the successful bidder will be required to attend a preconstruction conference with representatives of the PHA/IHA and its architect/engineer, and other interested parties convened by the PHA/IHA. The conference will serve to acquaint the participants with the general plan of the construction operation and all other requirements of the contract (e.g., Equal Employment Opportunity, Labor Standards). The PHA/IHA will provide the successful bidder with the date, time, and place of the conference.

#### **12. Indian Preference Requirements (applicable only if this solicitation is for a contract to be performed on a project for an Indian Housing Authority)**

(a) HUD has determined that the contract awarded under this solicitation is subject to the requirements of section 7(b) of the Indian Self-Determination and Education Assistance Act (25 U.S.C. 450e(b)). Section 7(b) requires that any contract or subcontract entered into for the benefit of Indians shall require that, to the greatest extent feasible

(1) Preferences and opportunities for training and employment (other than core crew positions; see paragraph (h) below) in connection with the administration of such contracts or subcontracts be given to qualified "Indians." The Act defines "Indians" to mean persons who are members of an Indian tribe and defines "Indian tribe" to mean any Indian tribe, band, nation, or other organized group or community, including any Alaska Native village or regional or village corporation as defined in or established pursuant to the Alaska Native Claims Settlement Act, which is recognized as eligible for the special programs and services provided by the United States to Indians because of their status as Indians; and,

(2) Preference in the award of contracts or subcontracts in connection with the administration of contracts be given to Indian organizations and to Indian-owned economic enterprises, as defined in section 3 of the Indian Financing Act of 1974 (25 U.S.C. 1452). That Act defines "economic enterprise" to mean any Indian-owned commercial, industrial, or business activity established or organized for the purpose of profit, except that the Indian ownership must constitute not less than 51 percent of the enterprise; "Indian organization" to mean the governing body of any Indian tribe or entity established or recognized by such governing body; "Indian" to mean any person who is a member of any tribe, band, group, pueblo, or community which is recognized by the Federal Government as eligible for services from the Bureau of Indian Affairs and any "Native" as defined in the Alaska Native Claims Settlement Act; and Indian "tribe" to mean any Indian tribe, band, group, pueblo, or community including Native villages and Native groups (including

corporations organized by Kenai, Juneau, Sitka, and Kodiak) as defined in the Alaska Native Claims Settlement Act, which is recognized by the Federal Government as eligible for services from the Bureau of Indian Affairs.

(b) (1) The successful Contractor under this solicitation shall comply with the requirements of this provision in awarding all subcontracts under the contract and in providing training and employment opportunities.

(2) A finding by the IHA that the contractor, either (i) awarded a subcontract without using the procedure required by the IHA, (ii) falsely represented that subcontracts would be awarded to Indian enterprises or organizations; or, (iii) failed to comply with the contractor's employment and training preference bid statement shall be grounds for termination of the contract or for the assessment of penalties or other remedies.

(c) If specified elsewhere in this solicitation, the IHA may restrict the solicitation to qualified Indian-owned enterprises and Indian organizations. If two or more (or a greater number as specified elsewhere in the solicitation) qualified Indian-owned enterprises or organizations submit responsive bids, award shall be made to the qualified enterprise or organization with the lowest responsive bid. If fewer than the minimum required number of qualified Indian-owned enterprises or organizations submit responsive bids, the IHA shall reject all bids and readvertise the solicitation in accordance with paragraph (d) below.

(d) If the IHA prefers not to restrict the solicitation as described in paragraph (c) above, or if after having restricted a solicitation an insufficient number of qualified Indian enterprises or organizations submit bids, the IHA may advertise for bids from non-Indian as well as Indian-owned enterprises and Indian organizations. Award shall be made to the qualified Indian enterprise or organization with the lowest responsive bid if that bid is -

(1) Within the maximum HUD-approved budget amount established for the specific project or activity for which bids are being solicited; and

(2) No more than the percentage specified in 24 CFR 905.175(c) higher than the total bid price of the lowest responsive bid from any qualified bidder. If no responsive bid by a qualified Indian-owned economic enterprise or organization is within the stated range of the total bid price of the lowest responsive bid from any qualified enterprise, award shall be made to the bidder with the lowest bid.

(e) Bidders seeking to qualify for preference in contracting or subcontracting shall submit proof of Indian ownership with their bids. Proof of Indian ownership shall include but not be limited to:

(1) Certification by a tribe or other evidence that the bidder is an Indian. The IHA shall accept the certification of a tribe that an individual is a member.

(2) Evidence such as stock ownership, structure, management, control, financing and salary or profit sharing arrangements of the enterprise.

(f) (1) All bidders must submit with their bids a statement describing how they will provide Indian preference in the award of subcontracts. The specific requirements of that statement and the factors to be used by the IHA in determining the statement's adequacy are included as an attachment to this solicitation. Any bid that fails to include the required statement shall be rejected as nonresponsive. The IHA may require that comparable statements be provided by subcontractors to the successful Contractor, and may require the Contractor to reject any bid or proposal by a subcontractor that fails to include the statement.

(2) Bidders and prospective subcontractors shall submit a certification (supported by credible evidence) to the IHA in any instance where the bidder or subcontractor believes it is infeasible to provide Indian preference in subcontracting. The acceptance or rejection by the IHA of the certification shall be final. Rejection shall disqualify the bid from further consideration.

(g) All bidders must submit with their bids a statement detailing their employment and training opportunities and their plans to provide preference to Indians in implementing the contract; and the number or percentage of Indians anticipated to be employed and trained. Comparable statements from all proposed subcontractors must be submitted. The criteria to be used by the IHA in determining the statement(s)'s adequacy are included as an attachment to this solicitation. Any bid that fails to include the required statement(s), or that includes a statement that does not meet minimum standards required by the IHA shall be rejected as nonresponsive.

(h) Core crew employees. A core crew employee is an individual who is a bona fide employee of the contractor at the time the bid is submitted; or an individual who was not employed by the bidder at the time the bid was submitted, but who is regularly employed by the bidder in a supervisory or other key skilled position when work is available. Bidders shall submit with their bids a list of all core crew employees.

(i) Preference in contracting, subcontracting, employment, and training shall apply not only on-site, on the reservation, or within the IHA's jurisdiction, but also to contracts with firms that operate outside these areas (e.g., employment in modular or manufactured housing construction facilities).

(j) Bidders should contact the IHA to determine if any additional local preference requirements are applicable to this solicitation.

(k) The IHA [ ] does [ ] does not [Contracting Officer check applicable box] maintain lists of Indian-owned economic enterprises and Indian organizations by specialty (e.g., plumbing, electrical, foundations), which are available to bidders to assist them in meeting their responsibility to provide preference in connection with the administration of contracts and subcontracts.



# Attachment B-1

## SF-LLL

### Disclosure of Lobbying Activities



# DISCLOSURE OF LOBBYING ACTIVITIES

Approved by OMB

Complete this form to disclose lobbying activities pursuant to 31 U.S.C. 1352

0348-0046

(See reverse for public burden disclosure.)

<b>1. Type of Federal Action:</b> <input type="checkbox"/> a. contract <input type="checkbox"/> b. grant <input type="checkbox"/> c. cooperative agreement <input type="checkbox"/> d. loan <input type="checkbox"/> e. loan guarantee <input type="checkbox"/> f. loan insurance	<b>2. Status of Federal Action:</b> <input type="checkbox"/> a. bid/offer/application <input type="checkbox"/> b. initial award <input type="checkbox"/> c. post-award	<b>3. Report Type:</b> <input type="checkbox"/> a. initial filing <input type="checkbox"/> b. material change <b>For Material Change Only:</b> year _____ quarter _____ date of last report _____
<b>4. Name and Address of Reporting Entity:</b> <input type="checkbox"/> Prime <input type="checkbox"/> Subawardee Tier _____, <i>if known</i> :  <b>Congressional District, if known:</b>	<b>5. If Reporting Entity in No. 4 is a Subawardee, Enter Name and Address of Prime:</b>   <b>Congressional District, if known:</b>	
<b>6. Federal Department/Agency:</b>	<b>7. Federal Program Name/Description:</b>  CFDA Number, <i>if applicable</i> : _____	
<b>8. Federal Action Number, if known:</b>	<b>9. Award Amount, if known:</b> \$ _____	
<b>10. a. Name and Address of Lobbying Registrant</b> <i>(if individual, last name, first name, MI):</i>	<b>b. Individuals Performing Services</b> <i>(including address if different from No. 10a)</i> <i>(last name, first name, MI):</i>	
<b>11.</b> Information requested through this form is authorized by title 31 U.S.C. section 1352. This disclosure of lobbying activities is a material representation of fact upon which reliance was placed by the tier above when this transaction was made or entered into. This disclosure is required pursuant to 31 U.S.C. 1352. This information will be available for public inspection. Any person who fails to file the required disclosure shall be subject to a civil penalty of not less than \$10,000 and not more than \$100,000 for each such failure.	Signature: _____ Print Name: _____ Title: _____ Telephone No.: _____ Date: _____	
<b>Federal Use Only:</b>		Authorized for Local Reproduction Standard Form LLL (Rev. 7-97)

## INSTRUCTIONS FOR COMPLETION OF SF-LLL, DISCLOSURE OF LOBBYING ACTIVITIES

This disclosure form shall be completed by the reporting entity, whether subawardee or prime Federal recipient, at the initiation or receipt of a covered Federal action, or a material change to a previous filing, pursuant to title 31 U.S.C. section 1352. The filing of a form is required for each payment or agreement to make payment to any lobbying entity for influencing or attempting to influence an officer or employee of any agency, a Member of Congress, an officer or employee of Congress, or an employee of a Member of Congress in connection with a covered Federal action. Complete all items that apply for both the initial filing and material change report. Refer to the implementing guidance published by the Office of Management and Budget for additional information.

1. Identify the type of covered Federal action for which lobbying activity is and/or has been secured to influence the outcome of a covered Federal action.
2. Identify the status of the covered Federal action.
3. Identify the appropriate classification of this report. If this is a followup report caused by a material change to the information previously reported, enter the year and quarter in which the change occurred. Enter the date of the last previously submitted report by this reporting entity for this covered Federal action.
4. Enter the full name, address, city, State and zip code of the reporting entity. Include Congressional District, if known. Check the appropriate classification of the reporting entity that designates if it is, or expects to be, a prime or subaward recipient. Identify the tier of the subawardee, e.g., the first subawardee of the prime is the 1st tier. Subawards include but are not limited to subcontracts, subgrants and contract awards under grants.
5. If the organization filing the report in item 4 checks "Subawardee," then enter the full name, address, city, State and zip code of the prime Federal recipient. Include Congressional District, if known.
6. Enter the name of the Federal agency making the award or loan commitment. Include at least one organizational level below agency name, if known. For example, Department of Transportation, United States Coast Guard.
7. Enter the Federal program name or description for the covered Federal action (item 1). If known, enter the full Catalog of Federal Domestic Assistance (CFDA) number for grants, cooperative agreements, loans, and loan commitments.
8. Enter the most appropriate Federal identifying number available for the Federal action identified in item 1 (e.g., Request for Proposal (RFP) number; Invitation for Bid (IFB) number; grant announcement number; the contract, grant, or loan award number; the application/proposal control number assigned by the Federal agency). Include prefixes, e.g., "RFP-DE-90-001."
9. For a covered Federal action where there has been an award or loan commitment by the Federal agency, enter the Federal amount of the award/loan commitment for the prime entity identified in item 4 or 5.
10. (a) Enter the full name, address, city, State and zip code of the lobbying registrant under the Lobbying Disclosure Act of 1995 engaged by the reporting entity identified in item 4 to influence the covered Federal action.  
  
(b) Enter the full names of the individual(s) performing services, and include full address if different from 10 (a). Enter Last Name, First Name, and Middle Initial (MI).
11. The certifying official shall sign and date the form, print his/her name, title, and telephone number.

According to the Paperwork Reduction Act, as amended, no persons are required to respond to a collection of information unless it displays a valid OMB Control Number. The valid OMB control number for this information collection is OMB No. 0348-0046. Public reporting burden for this collection of information is estimated to average 10 minutes per response, including time for reviewing instructions, searching existing data sources, gathering and maintaining the data needed, and completing and reviewing the collection of information. Send comments regarding the burden estimate or any other aspect of this collection of information, including suggestions for reducing this burden, to the Office of Management and Budget, Paperwork Reduction Project (0348-0046), Washington, DC 20503.

**Attachment B-2  
HUD-50071  
Certification of  
Payments to  
Influence Federal  
Transactions**





# Certification of Payments to Influence Federal Transactions

U.S. Department of Housing  
and Urban Development  
Office of Public and Indian Housing

Public reporting burden for this information collection is estimated to average 30 minutes. This includes the time for collecting, reviewing, and reporting data. The information requested is required to obtain a benefit. This form is used to ensure federal funds are not used to influence members of Congress. There are no assurances of confidentiality. HUD may not conduct or sponsor, and an applicant is not required to respond to a collection of information unless it displays a currently valid OMB control number.

Applicant Name

Program/Activity Receiving Federal Grant Funding

The undersigned certifies, to the best of his or her knowledge and belief, that:

(1) No Federal appropriated funds have been paid or will be paid, by or on behalf of the undersigned, to any person for influencing or attempting to influence an officer or employee of an agency, a Member of Congress, an officer or employee of Congress, or an employee of a Member of Congress in connection with the awarding of any Federal contract, the making of any Federal grant, the making of any Federal loan, the entering into of any cooperative agreement, and the extension, continuation, renewal, amendment, or modification of any Federal contract, grant, loan, or cooperative agreement.

(2) If any funds other than Federal appropriated funds have been paid or will be paid to any person for influencing or attempting to influence an officer or employee of an agency, a Member of Congress, an officer or employee of Congress, or an employee of a Member of Congress in connection with this Federal contract, grant, loan, or cooperative agreement, the undersigned shall complete and submit Standard Form-LLL, Disclosure Form to Report Lobbying, in accordance with its instructions.

(3) The undersigned shall require that the language of this certification be included in the award documents for all subawards at all tiers (including subcontracts, subgrants, and contracts under grants, loans, and cooperative agreements) and that all sub recipients shall certify and disclose accordingly.

This certification is a material representation of fact upon which reliance was placed when this transaction was made or entered into. Submission of this certification is a prerequisite for making or entering into this transaction imposed by Section 1352, Title 31, U.S. Code. Any person who fails to file the required certification shall be subject to a civil penalty of not less than \$10,000 and not more than \$100,000 for each such failure.

I hereby certify that all the information stated herein, as well as any information provided in the accompaniment herewith, is true and accurate.

**Warning:** HUD will prosecute false claims and statements. Conviction may result in criminal and/or civil penalties. (18 U.S.C. 1001, 1010, 1012; 31 U.S.C. 3729, 3802)

Name of Authorized Official

Title

Signature

Date (mm/dd/yyyy)

**Attachment B-3**  
**HUD-50070**  
**Certification of a**  
**Drug-Free Workplace**



# Certification for a Drug-Free Workplace

U.S. Department of Housing  
and Urban Development

Applicant Name

Program/Activity Receiving Federal Grant Funding

Acting on behalf of the above named Applicant as its Authorized Official, I make the following certifications and agreements to the Department of Housing and Urban Development (HUD) regarding the sites listed below:

I certify that the above named Applicant will or will continue to provide a drug-free workplace by:

a. Publishing a statement notifying employees that the unlawful manufacture, distribution, dispensing, possession, or use of a controlled substance is prohibited in the Applicant's workplace and specifying the actions that will be taken against employees for violation of such prohibition.

b. Establishing an on-going drug-free awareness program to inform employees ---

(1) The dangers of drug abuse in the workplace;

(2) The Applicant's policy of maintaining a drug-free workplace;

(3) Any available drug counseling, rehabilitation, and employee assistance programs; and

(4) The penalties that may be imposed upon employees for drug abuse violations occurring in the workplace.

c. Making it a requirement that each employee to be engaged in the performance of the grant be given a copy of the statement required by paragraph a.;

d. Notifying the employee in the statement required by paragraph a. that, as a condition of employment under the grant, the employee will ---

(1) Abide by the terms of the statement; and

(2) Notify the employer in writing of his or her conviction for a violation of a criminal drug statute occurring in the workplace no later than five calendar days after such conviction;

e. Notifying the agency in writing, within ten calendar days after receiving notice under subparagraph d.(2) from an employee or otherwise receiving actual notice of such conviction. Employers of convicted employees must provide notice, including position title, to every grant officer or other designee on whose grant activity the convicted employee was working, unless the Federalagency has designated a central point for the receipt of such notices. Notice shall include the identification number(s) of each affected grant;

f. Taking one of the following actions, within 30 calendar days of receiving notice under subparagraph d.(2), with respect to any employee who is so convicted ---

(1) Taking appropriate personnel action against such an employee, up to and including termination, consistent with the requirements of the Rehabilitation Act of 1973, as amended; or

(2) Requiring such employee to participate satisfactorily in a drug abuse assistance or rehabilitation program approved for such purposes by a Federal, State, or local health, law enforcement, or other appropriate agency;

g. Making a good faith effort to continue to maintain a drug-free workplace through implementation of paragraphs a. thru f.

**2. Sites for Work Performance.** The Applicant shall list (on separate pages) the site(s) for the performance of work done in connection with the HUD funding of the program/activity shown above: Place of Performance shall include the street address, city, county, State, and zip code. Identify each sheet with the Applicant name and address and the program/activity receiving grant funding.)

Check here  if there are workplaces on file that are not identified on the attached sheets.

I hereby certify that all the information stated herein, as well as any information provided in the accompaniment herewith, is true and accurate.

**Warning:** HUD will prosecute false claims and statements. Conviction may result in criminal and/or civil penalties.  
(18 U.S.C. 1001, 1010, 1012; 31 U.S.C. 3729, 3802)

Name of Authorized Official		Title
Signature		Date
X		

# Attachment C

# Profile of Firm Form





**PROFILE OF FIRM FORM**  
**(Attachment C)**

**Does the Contractor intend to hire Sub-Contractors? Yes \_\_\_\_\_ No \_\_\_\_\_ If yes, this form MUST be submitted for EACH Sub-Contractor.**

(This Form must be fully completed and included in the "hard copy" as a required bid submittal.)

(1) Prime \_\_\_\_\_ Sub-contractor \_\_\_\_\_ (This form must be completed by and for each).

(2) Name of Firm: \_\_\_\_\_ Telephone: \_\_\_\_\_ Fax: \_\_\_\_\_

(3) Street Address, City, State, Zip: \_\_\_\_\_

(4) Please attach a brief biography/resume of the company, including the following information:

(a) Year Firm Established; (b) Year Firm Established in [JURISDICTION]; (c) Former Name and Year Established (if applicable); (d) Name of Parent Company and Date Acquired (if applicable).

(5) Identify Principals/Partners in Firm (submit under Tab No. 5 a brief professional resume for each):

NAME	TITLE	% OF OWNERSHIP

(6) Identify the individual(s) that will act as project manager and any other supervisory personnel that will work on project; please submit under Tab No. 5 a brief resume for each. (Do not duplicate any resumes required above):

NAME	TITLE

(7) Bidder Diversity Statement: You must circle all of the following that apply to the ownership of this firm and enter where provided the correct percentage (%) of ownership of each:

Caucasian American (Male) \_\_\_\_\_%     
  Public-Held Corporation \_\_\_\_\_%     
  Government Agency \_\_\_\_\_%     
  Non-Profit Organization \_\_\_\_\_%

Resident- (RBE), Minority- (MBE), or Woman-Owned (WBE) Business Enterprise (Qualifies by virtue of 51% or more ownership and active management by one or more of the following:

Resident-Owned\* \_\_\_\_\_%     
  African American \_\_\_\_\_%     
  \*\*Native American \_\_\_\_\_%     
  Hispanic American \_\_\_\_\_%     
  Asian/Pacific American \_\_\_\_\_%     
  Hasidic Jew \_\_\_\_\_%     
  Asian/Indian American \_\_\_\_\_%

Woman-Owned (MBE) \_\_\_\_\_%     
  Woman-Owned (Caucasian) \_\_\_\_\_%     
  Disabled Veteran \_\_\_\_\_%     
  Other (Specify): \_\_\_\_\_%

WMBE Certification Number (if known): \_\_\_\_\_

Certified by (Agency): \_\_\_\_\_

\_\_\_\_\_  
Signature    Date    Printed Name    Company

**PROFILE OF FIRM FORM**  
**(Attachment C)**

**(This Form must be fully completed and submitted in "hard copy" as a required bid submittal.)**

- (8) Federal Tax ID No.: \_\_\_\_\_
- (9) [APPROPRIATE JURISDICTION] Business License No.: \_\_\_\_\_
- (10) State of \_\_\_\_\_ License Type and No.: \_\_\_\_\_
- (11) Worker's Compensation Insurance Carrier: \_\_\_\_\_  
Policy No.: \_\_\_\_\_ Expiration Date: \_\_\_\_\_
- (12) General Liability Insurance Carrier: \_\_\_\_\_  
Policy No. \_\_\_\_\_ Expiration Date: \_\_\_\_\_
- (13) Professional Liability Insurance Carrier: \_\_\_\_\_  
Policy No. \_\_\_\_\_ Expiration Date: \_\_\_\_\_
- (14) Debarred Statement: Has this firm, or any principal(s) ever been debarred from providing any services by the Federal Government, any state government, the State of \_\_\_\_\_, or any local government agency within or without the State of \_\_\_\_\_? Yes  No   
If "Yes," please attach a full detailed explanation, including dates, circumstances and current status.
- (15) Disclosure Statement: Does this firm or any principals thereof have any current, past personal or professional relationship with any Commissioner or Officer of the HA? Yes  No   
If "Yes," please attach a full detailed explanation, including dates, circumstances and current status.
- (16) Non-Collusive Affidavit: The undersigned party submitting this bid hereby certifies that such bid is genuine and not collusive and that said bidder entity has not colluded, conspired, connived or agreed, directly or indirectly, with any bidder or person, to put in a sham bid or to refrain from proposing, and has not in any manner, directly or indirectly sought by agreement or collusion, or communication or conference, with any person, to fix the bid price of affiant or of any other bidder, to fix overhead, profit or cost element of said bid price, or that of any other bidder or to secure any advantage against the HA or any person interested in the proposed contract; and that all statements in said bid are true.
- (17) Verification Statement: The undersigned bidder hereby states that by completing and submitting this form he/she is verifying that all information provided herein is, to the best of his/her knowledge, true and accurate, and agrees that if the HA discovers that any information entered herein is false, that shall entitle the HA to not consider nor make award or to cancel any award with the undersigned party.

\_\_\_\_\_  
Signature

\_\_\_\_\_  
Date

\_\_\_\_\_  
Printed Name

\_\_\_\_\_  
Company

**Attachment D**  
**Section 3 Submittal**  
**Form (Complete if**  
**you plan to**  
**participate in**  
**Section 3)**



## Section 3 Business Preference Submittal Form

(Attachment D)

---

- 10 **Introduction:** This form must be fully completed, accompanied by all required attachments, for any bidder/bidder claiming a Section 3 Business Preference (hereinafter, "Preference").
- 11 This fully completed form and any attachments thereto, will become a part of any ensuing contract.
- 12 Each bidder/bidder shall mark an "X" where provided following for all that apply to his/her claim of a Preference.
- 13 The bidder/bidder shall provide as an attachment to this completed form a detailed work plan clearly explaining how each following "denoted effort" or "claim" will be accomplished). Failure on the part of the bidder/bidder to include any such required attachment fully explaining the claim of the bidder/bidder shall result in the HA not considering the claim for a Preference (though the HA will, if awarded, later require the bidder/bidder to submit the information to satisfy the Section 3 requirements of the ensuing contract).
- 14 Please note that, even if a bidder/bidder does not complete and submit this form claiming a Preference, the HA may require this form to be completed by the successful bidder/bidder as an attachment to the ensuing contract to document the Section 3 Plan required for the ensuing contract.
- 20 **Current Section 3 Status:** The undersigned bidder/bidder hereby claims that it is a Section 3 business concern and claims such preference in that he/she can provide evidence that (the bidder/bidder has attached justifying documentation for each item following marked with an "X"):
- 21  It is 51% or more owned by a Section 3 resident:
- 2.1.1  HA resident lease;
- 2.1.2  Evidence of participation in a public assistance program;
- 2.1.3  Articles of Incorporation;
- 2.1.4  Fictitious or Assumed Business Name Certificate;
- 2.1.5  List of owners/stockholders and % of each;
- 2.1.6  Latest Board minutes appointing officers;
- 2.1.7  Organization chart with names and titles and brief functional statement;
- 2.1.8  Partnership Agreement;
- 2.1.9  Corporation Annual Report.
- 22  At least 30% of its full time employees include persons that are currently Section 3 residents, or within 3 years of the date of first employment with the business concern were Section 3 residents:



2.2.1 To justify this claim, please see the immediate following:

(1)	(2)	(3)
Classification	Total Number of Current Permanent Employees	Total Number of Section 3 Resident Employees
Trainees		
Apprentices		
Journeypersons		
Laborers		
Supervisory		
Superintendent		
Professional		
Clerical		
Other:		

2.2.2 Attach a listing of all employees listed within column (3) above, including name and total annual income.

23        He/she has a commitment to subcontract in excess of 25% of the dollar award of all subcontracts to be awarded to a Section 3 business concern.

2.3.1 To justify this claim, please see the immediate following:

(1)	(2)	(3)
Name of Section 3 Firm Receiving the Subcontract	Total Amount of Subcontract(s)	Percentage the Subcontract(s) is/are of the Total Proposed Contract Amount
	\$	%
	\$	%
	\$	%

2.3.2 Attach for each firm listed immediately above:

2.3.2.1 A detailed description of the subcontracted activity; and

2.3.2.2 A fully completed Profile of Firm form.

30 **Section 3 Preference Claim, Training and Employment Opportunities:** The undersigned bidder/bidder hereby claims that it will, as detailed within 24 CFR §135.34, provide such "opportunities" as denoted following; to:

- 31  Residents of the housing development or developments for which the section 3 covered assistance is expended (category 1 residents);
- 32  Residents of other housing developments managed by the HA that is expending the section 3 covered housing assistance (category 2 residents);
- 33  Participants in HUD Youthbuild programs being carried out in the metropolitan area (or nonmetropolitan county) in which the section 3 covered assistance is expended (category 3 residents);
- 34  Other section 3 residents.

3.8 Section 3 Preference Claim, Section 3 Business Concerns: The undersigned bidder/bidder hereby claims that it will, as a result of the contract award, and as detailed within 24 CFR §135.36, provide such "opportunities" as denoted following; to:

- 41  Business concerns that are 51 percent or more owned by residents of the housing development or developments for which the section 3 covered assistance is expended, or whose full-time, permanent workforce includes 30 percent of these persons as employees (category 1 businesses);
- 42  Business concerns that are 51 percent or more owned by residents of other housing developments or developments managed by the HA that is expending the section 3 covered assistance, or whose full-time, permanent workforce includes 30 percent of these persons as employees (category 2 businesses); or
- 43  HUD Youthbuild programs being carried out in the metropolitan area (or nonmetropolitan county/parish) in which the section 3 covered assistance is expended (category 3 businesses).
- 44  Business concerns that are 51 percent or more owned by section 3 residents, or whose permanent, full-time workforce includes no less than 30 percent section 3 residents (category 4 businesses), or that subcontract in excess of 25 percent of the total amount of subcontracts to business concerns identified in paragraphs (a)(1)(i) and (a)(1)(ii) of this section.

5.0 As further detailed herein, which of the following priority are you claiming? (NOTE: Mark with an "X" the highest claimed Priority only.)

PRIORITY CLAIMED (Mark "X")	FACTOR DESCRIPTION
	SECTION 3 BUSINESS PREFERENCE PARTICIPATION:
	Priority I, Category 1a: Business concerns that are 51 percent or more owned by residents of the housing development or developments for which the Section 3-covered assistance is expended.
	Priority II, Category 1b: Business concerns whose workforce includes 30 percent of residents of the

	housing development for which the Section 3-covered assistance is expended, or within three (3) years of the date of first employment with the business concern, were residents of the Section 3-covered housing development.
	Priority III, Category 2a: Business concerns that are 51 percent or more owned by residents of any other housing development or developments.
	Priority IV, Category 2b: Business concerns whose workforce includes 30 percent of residents of any other public housing development or developments, or within three (3) years of the date of first employment with the business concern, were "Section 3" residents of any other public housing development.
	Priority V, Category 3: Business concerns participating in HUD Youth-build programs being carried out in the metropolitan area in which the Section 3-covered assistance is expended.
	Priority VI, Category 4a: Business concerns that are 51 percent or more owned by Section 3 residents in the metropolitan area, or whose permanent, full-time workforce includes no less than 30 percent of Section 3 residents in the metropolitan area, or within three (3) years of the date of employment with the business concern, were Section 3 residents in the metropolitan area.
	Priority VII, Category 4b: Business concerns that subcontract in excess of 25 percent of the total amount of subcontracts to Section 3 business concerns.

60 As detailed within 24 CFR §135, Appendix I, *Examples of Efforts To Offer Training and Employment Opportunities to Section 3 Residents*, denote the "efforts" your firm hereby formally commits to implement if you are awarded a contract:

- 61 \_\_\_ Entering into "first source" hiring agreements with organizations representing Section 3 residents.
- 62 \_\_\_ Sponsoring a HUD-certified "Step-Up" employment and training program for section 3 residents.
- 63 \_\_\_ Establishing training programs, which are consistent with the requirements of the Department of Labor, for public and Indian housing residents and other section 3 residents in the building trades.
- 64 \_\_\_ Advertising the training and employment positions by distributing flyers (which identify the positions to be filled, the qualifications required, and where to obtain additional information about the application process) to every occupied dwelling unit in the housing

development or developments where category 1 or category 2 persons (as these terms are defined in §135.34) reside.

- 6.5 \_\_\_ Advertising the training and employment positions by posting flyers (which identify the positions to be filled, the qualifications required, and where to obtain additional information about the application process) in the common areas or other prominent areas of the housing development or developments. For HAs, post such advertising in the housing development or developments where category 1 or category 2 persons reside; for all other recipients, post such advertising in the housing development or developments and transitional housing in the neighborhood or service area of the section 3 covered project.
- 6.6 \_\_\_ Contacting resident councils, resident management corporations, or other resident organizations, where they exist, in the housing development or developments where category 1 or category 2 persons reside, and community organizations in HUD-assisted neighborhoods, to request the assistance of these organizations in notifying residents of the training and employment positions to be filled.
- 6.7 \_\_\_ Sponsoring (scheduling, advertising, financing or providing in-kind services) a job informational meeting to be conducted by an HA or contractor representative or representatives at a location in the housing development or developments where category 1 or category 2 persons reside or in the neighborhood or service area of the section 3 covered project.
- 6.8 \_\_\_ Arranging assistance in conducting job interviews and completing job applications for residents of the housing development or developments where category 1 or category 2 persons reside and in the neighborhood or service area in which a section 3 project is located.
- 6.9 \_\_\_ Arranging for a location in the housing development or developments where category 1 persons reside, or the neighborhood or service area of the project, where job applications may be delivered to and collected by a recipient or contractor representative or representatives.
- 6.10 \_\_\_ Conducting job interviews at the housing development or developments where category 1 or category 2 persons reside, or at a location within the neighborhood or service area of the section 3 covered project.
- 6.11 \_\_\_ Contacting agencies administering HUD Youthbuild programs, and requesting their assistance in recruiting HUD Youthbuild program participants for the HA's or contractor's training and employment positions.
- 6.12 \_\_\_ Consulting with State and local agencies administering training programs funded through JTPA or JOBS, probation and parole agencies, unemployment compensation programs, community organizations and other officials or organizations to assist with recruiting Section 3 residents for the HA's or contractor's training and employment positions.
- 6.13 \_\_\_ Advertising the jobs to be filled through the local media, such as community television networks, newspapers of general circulation, and radio advertising.
- 6.14 \_\_\_ Employing a job coordinator, or contracting with a business concern that is licensed in the field of job placement (preferably one of the section 3 business concerns identified in part 135), that will undertake, on behalf of the HA, other recipient or contractor, the efforts to match



eligible and qualified section 3 residents with the training and employment positions that the HA or contractor intends to fill.

- 6.15 \_\_\_ For an HA, employing section 3 residents directly on either a permanent or a temporary basis to perform work generated by section 3 assistance. (This type of employment is referred to as "force account labor" in HUD's Indian housing regulations. See 24 CFR §905.102, and §905.201(a)(6).)
- 6.16 \_\_\_ Where there are more qualified section 3 residents than there are positions to be filled, maintaining a file of eligible qualified section 3 residents for future employment positions.
- 6.17 \_\_\_ Undertaking job counseling, education and related programs in association with local educational institutions.
- 6.18 \_\_\_ Undertaking such continued job training efforts as may be necessary to ensure the continued employment of section 3 residents previously hired for employment opportunities.
- 6.19 \_\_\_ After selection of bidders but prior to execution of contracts, incorporating into the contract a negotiated provision for a specific number of public housing or other section 3 residents to be trained or employed on the section 3 covered assistance.
- 6.20 \_\_\_ Coordinating plans and implementation of economic development (e.g., job training and preparation, business development assistance for residents) with the planning for housing and community development.

7.0 As detailed within 24 CFR §135, Appendix II, *Examples of Efforts To Award Contracts to Section 3 Business Concerns*, denote following the "efforts" your firm hereby formally commits to implement if you are awarded a contract:

- 7.1 \_\_\_ Utilizing procurement procedures for section 3 business concerns similar to those provided in 24 CFR part 905 for business concerns owned by Native Americans (see section III of this Appendix).
- 7.2 \_\_\_ In determining the responsibility of potential contractors, consider their record of section 3 compliance as evidenced by past actions and their current plans for the pending contract.
- 7.3 \_\_\_ Contacting business assistance agencies, minority contractors associations and community organizations to inform them of contracting opportunities and requesting their assistance in identifying section 3 businesses which may solicit bids or bids for contracts for work in connection with section 3 covered assistance.
- 7.4 \_\_\_ Advertising contracting opportunities by posting notices, which provide general information about the work to be contracted and where to obtain additional information, in the common areas or other prominent areas of the housing development or developments owned and managed by the HA.
- 7.5 \_\_\_ For HAs, contacting resident councils, resident management corporations, or other resident organizations, where they exist, and requesting their assistance in identifying category 1 and category 2 business concerns.

- 7.6 \_\_\_ Providing written notice to all known section 3 business concerns of the contracting opportunities. This notice should be in sufficient time to allow the section 3 business concerns to respond to the bid invitations or Invitation for Bids.
- 7.7 \_\_\_ Following up with section 3 business concerns that have expressed interest in the contracting opportunities by contacting them to provide additional information on the contracting opportunities.
- 7.8 \_\_\_ Coordinating pre-bid meetings at which section 3 business concerns could be informed of upcoming contracting and subcontracting opportunities.
- 7.9 \_\_\_ Carrying out workshops on contracting procedures and specific contract opportunities in a timely manner so that section 3 business concerns can take advantage of upcoming contracting opportunities, with such information being made available in languages other than English where appropriate.
- 7.10 \_\_\_ Advising section 3 business concerns as to where they may seek assistance to overcome limitations such as inability to obtain bonding, lines of credit, financing, or insurance.
- 7.11 \_\_\_ Arranging solicitations, times for the presentation of bids, quantities, specifications, and delivery schedules in ways to facilitate the participation of section 3 business concerns.
- 7.12 \_\_\_ Where appropriate, breaking out contract work items into economically feasible units to facilitate participation by section 3 business concerns.
- 7.13 \_\_\_ Contacting agencies administering HUD Youthbuild programs, and notifying these agencies of the contracting opportunities.
- 7.14 \_\_\_ Advertising the contracting opportunities through trade association papers and newsletters, and through the local media, such as community television networks, newspapers of general circulation, and radio advertising.
- 7.15 \_\_\_ Developing a list of eligible section 3 business concerns.
- 7.16 \_\_\_ For HAs, participating in the "Contracting with Resident-Owned Businesses" program provided under 24 CFR part 963.
- 7.17 \_\_\_ Establishing or sponsoring programs designed to assist residents of public or Indian housing in the creation and development of resident-owned businesses.
- 7.18 \_\_\_ Establishing numerical goals (number of awards and dollar amount of contracts) for award of contracts to section 3 business concerns.
- 7.19 \_\_\_ Supporting businesses which provide economic opportunities to low income persons by linking them to the support services available through the Small Business Administration (SBA), the Department of Commerce and comparable agencies at the State and local levels.
- 7.20 \_\_\_ Encouraging financial institutions, in carrying out their responsibilities under the Community Reinvestment Act, to provide no or low interest loans for providing working capital and other financial business needs.
- 7.21 \_\_\_ Actively supporting joint ventures with section 3 business concerns.

7.22 \_\_\_ Actively supporting the development or maintenance of business incubators which assist Section 3 business concerns.

8.0 The undersigned bidder/bidder hereby declares:

8.1 The information within this completed form (and any attachments) is, to the best of his/her knowledge, true and accurate.

8.2 He/she is aware that if the HA discovers that any such information is not true and accurate, such shall allow the HA to:

8.2.1 NOT award the bidder/bidder a Preference; and

8.2.2 If the HA deems such is warranted (e.g. in the case of submitting information the bidder/bidder knows to be untrue), declare such bidder/bidder to be nonresponsive and not allow the bidder/bidder to receive an award.

8.3 He/she is aware that if he/she receives an award as the result of this competitive solicitation, even though he/she may not receive a Preference from the HA as a result of this submittal, he/she will still be required to, to the greatest extent feasible, implement a Section 3 Plan, including a commitment to interview and consider hiring Section 3 persons (most specifically, residents of the HA) whenever the successful bidder/bidder has need to hire additional employees during the term of the ensuing contract.

\_\_\_\_\_  
Signature

\_\_\_\_\_  
Date

\_\_\_\_\_  
Printed Name

\_\_\_\_\_  
Company

**Attachment E**  
**HUD- 5369-A**  
**HANO**  
*Housing Authority of New Orleans*



**U.S. Department of Housing  
and Urban Development**  
Office of Public and Indian Housing

**Representations, Certifications,  
and Other Statements of Bidders**  
**Public and Indian Housing Programs**

# Representations, Certifications, and Other Statements of Bidders

## Public and Indian Housing Programs

### Table of Contents

Clause	Page
1. Certificate of Independent Price Determination	1
2. Contingent Fee Representation and Agreement	1
3. Certification and Disclosure Regarding Payments to Influence Certain Federal Transactions	1
4. Organizational Conflicts of Interest Certification	2
5. Bidder's Certification of Eligibility	2
6. Minimum Bid Acceptance Period	2
7. Small, Minority, Women-Owned Business Concern Representation	2
8. Indian-Owned Economic Enterprise and Indian Organization Representation	2
9. Certification of Eligibility Under the Davis-Bacon Act	3
10. Certification of Nonsegregated Facilities	3
11. Clean Air and Water Certification	3
12. Previous Participation Certificate	3
13. Bidder's Signature	3

### 1. Certificate of Independent Price Determination

#### (a) The bidder certifies that--

(1) The prices in this bid have been arrived at independently, without, for the purpose of restricting competition, any consultation, communication, or agreement with any other bidder or competitor relating to (i) those prices, (ii) the intention to submit a bid, or (iii) the methods or factors used to calculate the prices offered;

(2) The prices in this bid have not been and will not be knowingly disclosed by the bidder, directly or indirectly, to any other bidder or competitor before bid opening (in the case of a sealed bid solicitation) or contract award (in the case of a competitive proposal solicitation) unless otherwise required by law; and

(3) No attempt has been made or will be made by the bidder to induce any other concern to submit or not to submit a bid for the purpose of restricting competition.

(b) Each signature on the bid is considered to be a certification by the signatory that the signatory--

(1) Is the person in the bidder's organization responsible for determining the prices being offered in this bid or proposal, and that the signatory has not participated and will not participate in any action contrary to subparagraphs (a)(1) through (a)(3) above; or

(2) (i) Has been authorized, in writing, to act as agent for the following principals in certifying that those principals have not participated, and will not participate in any action contrary to subparagraphs (a)(1) through (a)(3) above.

\_\_\_\_\_ [insert full name of person(s) in the bidder's organization responsible for determining the prices offered in this bid or proposal, and the title of his or her position in the bidder's organization];

(ii) As an authorized agent, does certify that the principals named in subdivision (b)(2)(i) above have not participated, and will not participate, in any action contrary to subparagraphs (a)(1) through (a)(3) above; and

(iii) As an agent, has not personally participated, and will not participate in any action contrary to subparagraphs (a)(1) through (a)(3) above.

(c) If the bidder deletes or modifies subparagraph (a)2 above, the bidder must furnish with its bid a signed statement setting forth in detail the circumstances of the disclosure.

[ ] [Contracting Officer check if following paragraph is applicable]

(d) Non-collusive affidavit. (applicable to contracts for construction and equipment exceeding \$50,000)

(1) Each bidder shall execute, in the form provided by the PHA/IHA, an affidavit to the effect that he/she has not colluded with any other person, firm or corporation in regard to any bid submitted in response to this solicitation. If the successful bidder did not submit the affidavit with his/her bid, he/she must submit it within three (3) working days of bid opening. Failure to submit the affidavit by that date may render the bid nonresponsive. No contract award will be made without a properly executed affidavit.

(2) A fully executed "Non-collusive Affidavit" [ ] is, [ ] is not included with the bid.

### 2. Contingent Fee Representation and Agreement

(a) Definitions. As used in this provision:

"Bona fide employee" means a person, employed by a bidder and subject to the bidder's supervision and control as to time, place, and manner of performance, who neither exerts, nor proposes to exert improper influence to solicit or obtain contracts nor holds out as being able to obtain any contract(s) through improper influence.

"Improper influence" means any influence that induces or tends to induce a PHA/IHA employee or officer to give consideration or to act regarding a PHA/IHA contract on any basis other than the merits of the matter.

(b) The bidder represents and certifies as part of its bid that, except for full-time bona fide employees working solely for the bidder, the bidder:

(1) [ ] has, [ ] has not employed or retained any person or company to solicit or obtain this contract; and

(2) [ ] has, [ ] has not paid or agreed to pay to any person or company employed or retained to solicit or obtain this contract any commission, percentage, brokerage, or other fee contingent upon or resulting from the award of this contract.

(c) If the answer to either (a)(1) or (a)(2) above is affirmative, the bidder shall make an immediate and full written disclosure to the PHA/IHA Contracting Officer.

(d) Any misrepresentation by the bidder shall give the PHA/IHA the right to (1) terminate the contract; (2) at its discretion, deduct from contract payments the amount of any commission, percentage, brokerage, or other contingent fee; or (3) take other remedy pursuant to the contract.

### 3. Certification and Disclosure Regarding Payments to Influence Certain Federal Transactions (applicable to contracts exceeding \$100,000)

(a) The definitions and prohibitions contained in Section 1352 of title 31, United States Code, are hereby incorporated by reference in paragraph (b) of this certification.

(b) The bidder, by signing its bid, hereby certifies to the best of his or her knowledge and belief as of December 23, 1989 that:

(1) No Federal appropriated funds have been paid or will be paid to any person for influencing or attempting to influence an officer or employee of any agency, a Member of Congress, an officer or employee of Congress, or an employee of a Member of Congress on his or her behalf in connection with the awarding of a contract resulting from this solicitation;

(2) If any funds other than Federal appropriated funds (including profit or fee received under a covered Federal transaction) have been paid, or will be paid, to any person for influencing or attempting to influence an officer or employee of any agency, a Member of Congress, an officer or employee of Congress, or an employee of a Member of Congress on his or her behalf in connection with this solicitation, the bidder shall complete and submit, with its bid, OMB standard form LLL, "Disclosure of Lobbying Activities;" and

(3) He or she will include the language of this certification in all subcontracts at any tier and require that all recipients of subcontract awards in excess of \$100,000 shall certify and disclose accordingly.

(c) Submission of this certification and disclosure is a prerequisite for making or entering into this contract imposed by section 1352, title 31, United States Code. Any person who makes an expenditure prohibited under this provision or who fails to file or amend the disclosure form to be filed or amended by this provision, shall be subject to a civil penalty of not less than \$10,000, and not more than \$100,000, for each such failure.

(d) Indian tribes (except those chartered by States) and Indian organizations as defined in section 4 of the Indian Self-Determination and Education Assistance Act (25 U.S.C. 450B) are exempt from the requirements of this provision.

#### 4. Organizational Conflicts of Interest Certification

The bidder certifies that to the best of its knowledge and belief and except as otherwise disclosed, he or she does not have any organizational conflict of interest which is defined as a situation in which the nature of work to be performed under this proposed contract and the bidder's organizational, financial, contractual, or other interests may, without some restriction on future activities:

- (a) Result in an unfair competitive advantage to the bidder; or,
- (b) Impair the bidder's objectivity in performing the contract work.

[ ] In the absence of any actual or apparent conflict, I hereby certify that to the best of my knowledge and belief, no actual or apparent conflict of interest exists with regard to my possible performance of this procurement.

#### 5. Bidder's Certification of Eligibility

(a) By the submission of this bid, the bidder certifies that to the best of its knowledge and belief, neither it, nor any person or firm which has an interest in the bidder's firm, nor any of the bidder's subcontractors, is ineligible to:

(1) Be awarded contracts by any agency of the United States Government, HUD, or the State in which this contract is to be performed; or,

(2) Participate in HUD programs pursuant to 24 CFR Part 24.

(b) The certification in paragraph (a) above is a material representation of fact upon which reliance was placed when making award. If it is later determined that the bidder knowingly rendered an erroneous certification, the contract may be terminated for default, and the bidder may be debarred or suspended from participation in HUD programs and other Federal contract programs.

#### 6. Minimum Bid Acceptance Period

(a) "Acceptance period," as used in this provision, means the number of calendar days available to the PHA/IHA for awarding a contract from the date specified in this solicitation for receipt of bids.

(b) This provision supersedes any language pertaining to the acceptance period that may appear elsewhere in this solicitation.

(c) The PHA/IHA requires a minimum acceptance period of [Contracting Officer insert time period] calendar days.

(d) In the space provided immediately below, bidders may specify a longer acceptance period than the PHA's/IHA's minimum requirement. The bidder allows the following acceptance period: calendar days.

(e) A bid allowing less than the PHA's/IHA's minimum acceptance period will be rejected.

(f) The bidder agrees to execute all that it has undertaken to do, in compliance with its bid, if that bid is accepted in writing within (1) the acceptance period stated in paragraph (c) above or (2) any longer acceptance period stated in paragraph (d) above.

#### 7. Small, Minority, Women-Owned Business Concern Representation

The bidder represents and certifies as part of its bid/ offer that it --

(a) [ ] is, [ ] is not a small business concern. "Small business concern," as used in this provision, means a concern, including its affiliates, that is independently owned and operated, not dominant in the field of operation in which it is bidding, and qualified as a small business under the criteria and size standards in 13 CFR 121.

(b) [ ] is, [ ] is not a women-owned business enterprise. "Women-owned business enterprise," as used in this provision, means a business that is at least 51 percent owned by a woman or women who are U.S. citizens and who also control and operate the business.

(c) [ ] is, [ ] is not a minority business enterprise. "Minority business enterprise," as used in this provision, means a business which is at least 51 percent owned or controlled by one or more minority group members or, in the case of a publicly owned business, at least 51 percent of its voting stock is owned by one or more minority group members, and whose management and daily operations are controlled by one or more such individuals. For the purpose of this definition, minority group members are:

(Check the block applicable to you)

- [ ] Black Americans
- [ ] Asian Pacific Americans
- [ ] Hispanic Americans
- [ ] Asian Indian Americans
- [ ] Native Americans
- [ ] Hasidic Jewish Americans

#### 8. Indian-Owned Economic Enterprise and Indian Organization Representation (applicable only if this solicitation is for a contract to be performed on a project for an Indian Housing Authority)

The bidder represents and certifies that it:

(a) [ ] is, [ ] is not an Indian-owned economic enterprise. "Economic enterprise," as used in this provision, means any commercial, industrial, or business activity established or organized for the purpose of profit, which is at least 51 percent Indian owned. "Indian," as used in this provision, means any person who is a member of any tribe, band, group, pueblo, or community which is recognized by the Federal Government as eligible for services from the Bureau of Indian Affairs and any "Native" as defined in the Alaska Native Claims Settlement Act.

(b) [ ] is, [ ] is not an Indian organization. "Indian organization," as used in this provision, means the governing body of any Indian tribe or entity established or recognized by such governing body. Indian "tribe" means any Indian tribe, band, group, pueblo, or

community including Native villages and Native groups (including corporations organized by Kenai, Juneau, Sitka, and Kodiak) as defined in the Alaska Native Claims Settlement Act, which is recognized by the Federal Government as eligible for services from the Bureau of Indian Affairs.

**9. Certification of Eligibility Under the Davis-Bacon Act** (applicable to construction contracts exceeding \$2,000)

(a) By the submission of this bid, the bidder certifies that neither it nor any person or firm who has an interest in the bidder's firm is a person or firm ineligible to be awarded contracts by the United States Government by virtue of section 3(a) of the Davis-Bacon Act or 29 CFR 5.12(a)(1).

(b) No part of the contract resulting from this solicitation shall be subcontracted to any person or firm ineligible to be awarded contracts by the United States Government by virtue of section 3(a) of the Davis-Bacon Act or 29 CFR 5.12(a)(1).

(c) The penalty for making false statements is prescribed in the U. S. Criminal Code, 18 U.S.C. 1001.

**10. Certification of Nonsegregated Facilities** (applicable to contracts exceeding \$10,000)

(a) The bidder's attention is called to the clause entitled **Equal Employment Opportunity** of the General Conditions of the Contract for Construction.

(b) "Segregated facilities," as used in this provision, means any waiting rooms, work areas, rest rooms and wash rooms, restaurants and other eating areas, time clocks, locker rooms and other storage or dressing areas, parking lots, drinking fountains, recreation or entertainment areas, transportation, and housing facilities provided for employees, that are segregated by explicit directive or are in fact segregated on the basis of race, color, religion, or national origin because of habit, local custom, or otherwise.

(c) By the submission of this bid, the bidder certifies that it does not and will not maintain or provide for its employees any segregated facilities at any of its establishments, and that it does not and will not permit its employees to perform their services at any location under its control where segregated facilities are maintained. The bidder agrees that a breach of this certification is a violation of the Equal Employment Opportunity clause in the contract.

(d) The bidder further agrees that (except where it has obtained identical certifications from proposed subcontractors for specific time periods) prior to entering into subcontracts which exceed \$10,000 and are not exempt from the requirements of the Equal Employment Opportunity clause, it will:

- (1) Obtain identical certifications from the proposed subcontractors;
- (2) Retain the certifications in its files; and
- (3) Forward the following notice to the proposed subcontractors (except if the proposed subcontractors have submitted identical certifications for specific time periods):

**Notice to Prospective Subcontractors of Requirement for Certifications of Nonsegregated Facilities**

A Certification of Nonsegregated Facilities must be submitted before the award of a subcontract exceeding \$10,000 which is not exempt from the provisions of the Equal Employment Opportunity clause of the prime contract. The certification may be submitted either for each subcontract or for all subcontracts during a period (i.e., quarterly, semiannually, or annually).

**Note:** The penalty for making false statements in bids is prescribed in 18 U.S.C. 1001.

**11. Clean Air and Water Certification** (applicable to contracts exceeding \$100,000)

The bidder certifies that:

(a) Any facility to be used in the performance of this contract [ ] is, [ ] is not listed on the Environmental Protection Agency List of Violating Facilities:

(b) The bidder will immediately notify the PHA/IHA Contracting Officer, before award, of the receipt of any communication from the Administrator, or a designee, of the Environmental Protection Agency, indicating that any facility that the bidder proposes to use for the performance of the contract is under consideration to be listed on the EPA List of Violating Facilities; and,

(c) The bidder will include a certification substantially the same as this certification, including this paragraph (c), in every nonexempt subcontract.

**12. Previous Participation Certificate** (applicable to construction and equipment contracts exceeding \$50,000)

(a) The bidder shall complete and submit with his/her bid the Form HUD-2530, "Previous Participation Certificate." If the successful bidder does not submit the certificate with his/her bid, he/she must submit it within three (3) working days of bid opening. Failure to submit the certificate by that date may render the bid nonresponsive. No contract award will be made without a properly executed certificate.

(b) A fully executed "Previous Participation Certificate" [ ] is, [ ] is not included with the bid.

**13. Bidder's Signature**

The bidder hereby certifies that the information contained in these certifications and representations is accurate, complete, and current.

\_\_\_\_\_  
(Signature and Date)

\_\_\_\_\_  
(Typed or Printed Name)

\_\_\_\_\_  
(Title)

\_\_\_\_\_  
(Company Name)

\_\_\_\_\_  
(Company Address)



# Attachment F Supplemental Conditions



## SUPPLEMENTAL CONDITIONS

### **The Contractor shall possess a major classification in Building Construction**

The following supplements and/or modifies the "General Conditions for Construction Contracts," form HUD-5370:

**Time of Completion.** The Contractor shall commence work under this contract at the time stipulated in the written "Notice to Proceed" (NTP) issued by the local authority. The Contractor shall complete the work in **12 months**. The work shall be considered complete only when the Local Authority has issued its formal "Certificate of Acceptance".

### **Liquidated Damages**

The cost per day in Liquidated Damages for delay on completion of this project is **\$500.00**.

### **Contract Type**

The contract resulting from this IFB shall be a fixed price contract.

### **Davis Bacon**

Davis Wage Rates are in effect for this project.

### **Bonding**

All bids must be accompanied by a bid bond/guarantee, which shall be in the form of a certified check, cashier's check, or bid bond for not more than five percent (5%) of the contract price of work to be done, as evidence of good faith of the bidder.

The awarded bidder will be required to provide a performance and payment bond in an amount not less than 100% of the amount of the contract, for faithful performance of their duties.

### **Employment, Training and Contracting Policy**

#### **PART I- POLICY, PURPOSE, REQUIREMENTS, DEFINITIONS**

- A. INTRODUCTION AND SUMMARY
- B. DEFINITIONS
- C. HANO SECTION 3 & DBE/WBE POLICY STATEMENTS
- D. SECTION 3 NEW HIRE AND CONTRACTING REQUIREMENTS
- E. DBE/WBE CONTRACT REQUIREMENTS

## **PART II- PROCUREMENT & CONTRACTOR REQUIREMENTS AND PROCEDURES**

- A. SECTION 3 CONTRACTING PROCEDURES.
- B. DBE/WBE CONTRACTING PROCEDURES
- C. REPORTING OPEN POSITIONS

## **PART III - COMPLIANCE REQUIREMENTS**

- A. COMPLIANCE REQUIREMENTS FOR HIRING & CONTRACTING
- B. PROJECT LABOR AGREEMENTS OR COMMUNITY WORKFORCE AGREEMENTS

## **PART IV - TRAINING REQUIREMENTS**

- A. TRAINING AND INTERNSHIP REQUIREMENTS

## **PART V - CONTRACTING AND COMPLIANCE FORMS**

- A. SECTION -3 INDIVIDUAL VERIFICATION FORM
- B. SECTION -3 EMPLOYMENT ACTION PLAN
- C. SECTION -3 TRAINING ACTION PLAN
- D. CONTRACTING ACTION PLAN FOR SECTION 3/DBE/WBE
- E. LIST OF CORE EMPLOYEES
- F. CONTRACTING SCHEDULE
- G. SECTION -3 EMPLOYMENT AND TRAINING SCHEDULE
- H. LETTER OF INTENT
- I. STATEMENT OF UNDERSTANDING
- J. CONTRACTORS SECTION -3 EMPLOYMENT AND TRAINING COMPLIANCE REPORT
- K. EMPLOYER PAID TRAINING REPORT
- L. SECTION -3 MANHOUR REPORT
- M. CONTRACTING COMPLIANCE REPORT
- N. EMPLOYMENT ASSESSMENT

### **Invoicing**

Invoices shall be submitted monthly to the Department of Finance with a copy to the Modernization and Development Department. The invoice shall provide an invoice number, service dates, purchase order number, Task Order number, and a description of services provided and the name/title of employee who rendered the services. Invoices shall be submitted on the contractor's own invoice form.

### **Payments**

All vendors should submit invoices to the Finance Department on or before the days listed below. All vendor invoices are due on the 1<sup>st</sup> or 15<sup>th</sup> of the month. Invoice payments are as follows:

- *Invoices received on the 16<sup>th</sup> of the current month thru the 1<sup>st</sup> day of the next month will be paid on the 1<sup>st</sup> of the following month.*

- **Example: An invoice received on August 27<sup>th</sup> will be processed commencing September 1<sup>st</sup> and paid on October 1<sup>st</sup>.**
- *Invoices received on the 2<sup>nd</sup> of the current month thru the 15<sup>th</sup> of the current month will be paid on the 15<sup>th</sup> of the following month.*
- **Example: An invoice received on August 4<sup>th</sup> will be processed commencing August 15<sup>th</sup> and paid on September 15<sup>th</sup>.**

#### **Request for Taxpayer Number and Certification (W-9)**

The respondent(s) shall provide a copy of its Request for Taxpayer Number and Certification (W-9) at the time and date specified by the Authority.

#### **Public Access to Procurement Information/Confidentiality**

All information submitted in response to a solicitation issued by the Housing Authority of New Orleans (HANO) shall remain confidential until after final approval by HANO's Board of Commissioners and/or the United States Department of Housing and Urban Development (HUD). HANO's policy regarding public access is in strict accordance with the guidelines set forth in its Procurement Policy, Section 5.3.4, HUD Handbook 7460.8 REV 2, Section 1.6, Public Access to Procurement Information and Section 7.2 (J) Confidentiality. Furthermore, pursuant to Louisiana Revised Statute 40:526(8), HANO shall not disclose information submitted to HANO in confidence in response to this IFB, and not otherwise required by law to be submitted, where such information should reasonably be considered confidential.

#### **Indemnification**

The successful Respondent(s) will be required to protect, defend, indemnify, keep, save, and hold HANO, its officers, officials, employees and agents free and harmless from and against any and all liabilities, losses, penalties, damages, settlements, environmental liability, costs, charges, professional fees or other expenses or liabilities of every kind, nature and character arising out of or relating to any and all claims, liens, demands, obligations, actions, suits, judgments or settlements, proceedings or causes of action of every kind, nature and character (collectively, "claims") in connection with or arising directly or indirectly out of the acts or omissions and/or the performance thereof by the successful Respondent, its officers, officials, agents, employees, and subcontractors, including, but not limited to, the enforcement of the indemnification provision. The successful Respondent(s) will be further required to investigate, handle, respond to, provide defense for and defend all suits for any and all claims, at its sole expense and agrees to bear all other costs and expenses related thereto, even if the claims are considered groundless, false or fraudulent.

HANO will have the right, at its option and at its expense, to participate in the defense of any suit, without relieving the successful Respondent of any of its obligations under this indemnity provision. The indemnities to be set forth in the contract resulting from this IFB will survive the expiration or termination of that contract.



### **Rights, Use, and Ownership of Assessment Materials**

Assessment materials generated as a result of performing the Scope of Services contained in this contract shall be confidential and proprietary, and shall be for the exclusive use and ownership of The Housing Authority of New Orleans. Such materials shall include, but not be limited to data, cost estimates, and reports generated that contain descriptive and/or identifying information regarding individual properties owned by HANO and/or HANO's portfolio of properties. Such materials shall not be shared, signed, sold or disclosed to parties other than those named on the contract without the express written permission of the Housing Authority of New Orleans' Contracting Officer. Any violations of this provision shall be considered a breach of, and grounds for immediate termination in accordance with the General Contract Conditions, HUD Form 5370-C, Paragraph 4, Termination for Convenience and Default.

### **Ethics Policy**

The selected Respondent shall abide by the applicable provisions of the Housing Authority of New Orleans' Ethics Policy and State of Louisiana Ethics Code.

### **Third Party Claims on Software**

HANO shall be held harmless from any third party legal claims involving the use by HANO of any software product or technique provided by the selected Respondent.

### **Licenses and Certifications**

The successful Respondent shall possess all of the required State and Local licenses and certifications required to perform work of the type required by this contract in the City of New Orleans. In addition, the Respondent shall comply with all laws, ordinances and regulations applicable to the services contemplated herein. Respondents are presumed to be familiar with all federal, state and local laws, ordinances, codes, rules and regulations that may in any way affect the delivery of services.

**The project shall be awarded only to contractors who are licensed under State of Louisiana Contractors License Law La. R.S. 37:2150-2192 with a major classification in Building Construction/Roofing.**

### **Contractual Obligations**

At any time, should the proposed services require the use of products or services of another company, such services shall be disclosed, and HANO will hold the selected respondent(s) responsible for the proposed services.

### **Certification of Legal Entity**

Prior to execution of the Contract Agreement, the Respondent shall certify that joint ventures, partnerships, team agreements, new corporations or other entities that either exist or will be formally structured are, or will be legal and binding under Louisiana law.

### **Certifications**

In submitting the bid, the Respondent is indicating a willingness to comply with all terms and conditions of the IFB, including but not limited to those set forth in HUD Form 5370-C, General Contract Conditions, Non-Construction, and these Supplemental Conditions.

### **Personnel**

In submitting their bids, Respondents are representing that the personnel described in their bids shall be available to perform the services described for the duration of the contract period, barring illness, accident or other unforeseeable events of a similar nature in which cases the Respondent must be able to provide a qualified replacement. Such representation shall be valid for a minimum of 120 calendar days after the bid due date and time. Furthermore, all personnel shall be considered to be, at all times, the sole employees of the Respondent under its sole direction, and not employees or agents of HANO.

### **Respondent Status**

The successful Respondent will be held to be an independent Consultant, and will not be an employee of HANO.

### **Assignment**

The successful Respondent shall not enter into any subcontracts, retain consultants, or assign, transfer, convey, sublet, or otherwise delegate its obligations under the contract resulting from this IFB, or any of its rights, title or interest therein, or its power to execute such contract to any person, company or corporation without the prior written consent and approval of the HANO.

### **Advertising**

In submitting a bid, the successful Respondent agrees not to use the results from it as a part of any commercial advertising. HANO does not permit law firms to advertise or promote the fact of their relationship with HANO in the course of marketing efforts, unless HANO specifically agrees otherwise.

### **Media Relations**

The Contractor shall not make public comment on HANO matters without express written approval from HANO's Director of Communications. All media inquiries shall be referred to the Administrative Receiver and to the Director of Communications.

### **Assumption of Risk**

Contractor is aware and acknowledges that HANO has no knowledge and/or duty to investigate the physical condition of any prospective property and/or the health conditions of any prospective property owners and/or occupants, including but not limited to tenants, subtenants, invitees, assignees, and/or any other person that has entered and/or lived in a prospective property. Contractor hereby agrees to assume any and all risk(s) associated with any potential infectious diseases, viruses, or the like, including but not

limited to COVID-19 (Novel Coronavirus Disease), that may be present in a prospective property and/or a prospective property's owner(s) and/or occupant(s). Contractor agrees, acknowledges, and assumes all potential risks, including risk of infection, transmission, and/or contraction of any infectious disease, virus, and/or illness, to view and/or enter a prospective property. Contractor further agrees to hold harmless and release HANO, including any and all agents, assigns, and/or successors, from any and all liability and/or potential claims, whether from Contractor or third party, arising from and/or in any way related to Contractor's alleged infection, transmission, and/or contraction of any infectious disease, virus, and/or illness from a prospective property, except any claim and/or cause of action arising from HANO's gross negligence and/or willful misconduct.

# Attachment G

## HUD 5370





# General Conditions for Construction Contracts - Public Housing Programs

U.S. Department of Housing and Urban  
Development  
Office of Public and Indian Housing  
OMB Approval No. 2577-0157 (exp. 11/30/2023)

**Applicability. This form is applicable to any  
construction/development contract greater than \$250,000.**

Public reporting burden for this collection of information is estimated to average 1 hour. This includes the time for collecting, reviewing, and reporting the data. The information requested is required to obtain a benefit. This form includes those clauses required by OMB's common rule on grantee procurement, implemented at HUD in 2 CFR 200, and those requirements set forth in Section 3 of the Housing and Urban Development Act of 1968 and its amendment by the Housing and Community Development Act of 1992, implemented by HUD at 24 CFR Part 75. The form is required for construction contracts awarded by Public Housing Agencies (PHAs). The form is used by Housing Authorities in solicitations to provide necessary contract clauses. If the form were not used, PHAs would be unable to enforce their contracts. There are no assurances of confidentiality. HUD may not conduct or sponsor, and an applicant is not required to respond to a collection of information unless it displays a currently valid OMB control number.

Clause		Page	Clause		Page
1.	Definitions	2	<b>Administrative Requirements</b>		
2.	Contractor's Responsibility for Work	2	25.	Contract Period	9
3.	Architect's Duties, Responsibilities and Authority	2	26.	Order of Precedence	9
4.	Other Contracts	3	27.	Payments	9
<b>Construction Requirements</b>			28.	Contract Modifications	10
5.	Preconstruction Conference and Notice to Proceed	3	29.	Changes	10
6.	Construction Progress Schedule	3	30.	Suspension of Work	11
7.	Site Investigation and Conditions Affecting the Work	3	31.	Disputes	11
8.	Differing Site Conditions	4	32.	Default	11
9.	Specifications and Drawings for Construction	4	33.	Liquidated	12
10.	As-Built Drawings	5	34.	Termination of Convenience	12
11.	Material and Workmanship	5	35.	Assignment of Contract	12
12.	Permits and Codes	5	36.	Insurance	12
13.	Health, Safety, and Accident Prevention	6	37.	Subcontracts	13
14.	Temporary Buildings and Transportation Materials	6	38.	Subcontracting with Small and Minority Firms, Women's Business Enterprise, and Labor Surplus Area Firms	13
15.	Availability and Use of Utility Services	6	39.	Equal Employment Opportunity	13
16.	Protection of Existing Vegetation, Structures, Equipment, Utilities, and Improvements	6	40.	Employment, Training, and Contracting Opportunities for Low-Income Persons, Section 3 of the Housing and Urban Development Act of 1968	14
17.	Temporary Buildings and Transportation Materials	7	41.	Interest of Members of Congress	15
18.	Clean Air and Water	7	42.	Interest of Members, Officers, or Employees and Former Members, Officers, or Employees	15
19.	Energy Efficiency	7	43.	Limitations on Payments Made to Influence	15
20.	Inspection and Acceptance of Construction	7	44.	Royalties and Patents	15
21.	Use and Possession Prior to	8	45.	Examination and Retention of Contractor's Records	15
22.	Warranty of Title	8	46.	Labor Standards-Davis-Bacon and Related Acts	15
23.	Warranty of	8	47.	Non-Federal Prevailing Wage Rates	19
24.	Prohibition Against Liens	9	48.	Procurement of Recovered Materials	19

---

## 1. Definitions

- (a) "Architect" means the person or other entity engaged by the PHA to perform architectural, engineering, design, and other services related to the work as provided for in the contract. When a PHA uses an engineer to act in this capacity, the terms "architect" and "engineer" shall be synonymous. The Architect shall serve as a technical representative of the Contracting Officer. The Architect's authority is as set forth elsewhere in this contract.
- (b) "Contract" means the contract entered into between the PHA and the Contractor. It includes the forms of Bid, the Bid Bond, the Performance and Payment Bond or Bonds or other assurance of completion, the Certifications, Representations, and Other Statements of Bidders (form HUD-5370), these General Conditions of the Contract for Construction (form HUD-5370), the applicable wage rate determinations from the U.S. Department of Labor, any special conditions included elsewhere in the contract, the specifications, and drawings. It includes all formal changes to any of those documents by addendum, change order, or other modification.
- (c) "Contracting Officer" means the person delegated the authority by the PHA to enter into, administer, and/or terminate this contract and designated as such in writing to the Contractor. The term includes any successor Contracting Officer and any duly authorized representative of the Contracting Officer also designated in writing. The Contracting Officer shall be deemed the authorized agent of the PHA in all dealings with the Contractor.
- (d) "Contractor" means the person or other entity entering into the contract with the PHA to perform all of the work required under the contract.
- (e) "Drawings" means the drawings enumerated in the schedule of drawings contained in the Specifications and as described in the contract clause entitled Specifications and Drawings for Construction herein.
- (f) "HUD" means the United States of America acting through the Department of Housing and Urban Development including the Secretary, or any other person designated to act on its behalf. HUD has agreed, subject to the provisions of an Annual Contributions Terms and Conditions (ACC), to provide financial assistance to the PHA, which includes assistance in financing the work to be performed under this contract. As defined elsewhere in these General Conditions or the contract documents, the determination of HUD may be required to authorize changes in the work or for release of funds to the PHA for payment to the Contractor. Notwithstanding HUD's role, nothing in this contract shall be construed to create any contractual relationship between the Contractor and HUD.
- (g) "Project" means the entire project, whether construction or rehabilitation, the work for which is provided for in whole or in part under this contract.
- (h) "PHA" means the Public Housing Agency organized under applicable state laws which is a party to this contract.
- (j) "Specifications" means the written description of the technical requirements for construction and includes the criteria and tests for determining whether the requirements are met.
- (l) "Work" means materials, workmanship, and manufacture and fabrication of components.

## 2. Contractor's Responsibility for Work

- (a) The Contractor shall furnish all necessary labor, materials, tools, equipment, and transportation necessary for performance of the work. The Contractor shall also furnish all necessary water, heat, light, and power not made available to the Contractor by the PHA pursuant to the clause entitled Availability and Use of Utility Services herein.
- (b) The Contractor shall perform on the site, and with its own organization, work equivalent to at least [ ] (12 percent unless otherwise indicated) of the total amount of work to be performed under the order. This percentage may be reduced by a supplemental agreement to this order if, during performing the work, the Contractor requests a reduction and the Contracting Officer determines that the reduction would be to the advantage of the PHA.
- (c) At all times during performance of this contract and until the work is completed and accepted, the Contractor shall directly superintend the work or assign and have on the work site a competent superintendent who is satisfactory to the Contracting Officer and has authority to act for the Contractor.
- (d) The Contractor shall be responsible for all damages to persons or property that occur as a result of the Contractor's fault or negligence, and shall take proper safety and health precautions to protect the work, the workers, the public, and the property of others. The Contractor shall hold and save the PHA, its officers and agents, free and harmless from liability of any nature occasioned by the Contractor's performance. The Contractor shall also be responsible for all materials delivered and work performed until completion and acceptance of the entire work, except for any completed unit of work which may have been accepted under the contract.
- (e) The Contractor shall lay out the work from base lines and bench marks indicated on the drawings and be responsible for all lines, levels, and measurements of all work executed under the contract. The Contractor shall verify the figures before laying out the work and will be held responsible for any error resulting from its failure to do so.
- (f) The Contractor shall confine all operations (including storage of materials) on PHA premises to areas authorized or approved by the Contracting Officer.
- (g) The Contractor shall at all times keep the work area, including storage areas, free from accumulations of waste materials. After completing the work and before final inspection, the Contractor shall (1) remove from the premises all scaffolding, equipment, tools, and materials (including rejected materials) that are not the property of the PHA and all rubbish caused by its work; (2) leave the work area in a clean, neat, and orderly condition satisfactory to the Contracting Officer; (3) perform all specified tests; and, (4) deliver the installation in complete and operating condition.
- (h) The Contractor's responsibility will terminate when all work has been completed, the final inspection made, and the work accepted by the Contracting Officer. The Contractor will then be released from further obligation except as required by the warranties specified elsewhere in the contract.

## 3. Architect's Duties, Responsibilities, and Authority

- (a) The Architect for this contract, and any successor, shall be designated in writing by the Contracting Officer.

- (b) The Architect shall serve as the Contracting Officer's technical representative with respect to architectural, **Schedule** engineering, and design matters related to the work performed under the contract. The Architect may provide direction on contract performance. Such direction shall be within the scope of the contract and may not be of a nature which: (1) institutes additional work outside the scope of the contract; (2) constitutes a change as defined in the Changes clause herein; (3) causes an increase or decrease in the cost of the contract; (4) alters the Construction Progress Schedule; or (5) changes any of the other express terms or conditions of the contract.
- (c) The Architect's duties and responsibilities may include but shall not be limited to:
- (1) Making periodic visits to the work site, and on the basis of his/her on-site inspections, issuing written reports to the PHA which shall include all observed deficiencies. The Architect shall file a copy of the report with the Contractor's designated representative at the site;
  - (2) Making modifications in drawings and technical specifications and assisting the Contracting Officer in the preparation of change orders and other contract modifications for issuance by the Contracting Officer;
  - (3) Reviewing and making recommendations with respect to - (i) the Contractor's construction progress schedules; (ii) the Contractor's shop and detailed drawings; (iii) the machinery, mechanical and other equipment and materials or other articles proposed for use by the Contractor; and, (iv) the Contractor's price breakdown and progress payment estimates; and,
  - (4) Assisting in inspections, signing Certificates of Completion, and making recommendations with respect to acceptance of work completed under the contract.

#### 4. Other Contracts

The PHA may undertake or award other contracts for additional work at or near the site of the work under this contract. The Contractor shall fully cooperate with the other contractors and with PHA employees and shall carefully adapt scheduling and performing the work under this contract to accommodate the additional work, heeding any direction that may be provided by the Contracting Officer. The Contractor shall not commit or permit any act that will interfere with the performance of work by any other contractor or by PHA employees

### Construction Requirements

#### 5. Pre-construction Conference and Notice to Proceed

of the work, and that it has investigated and satisfied itself

- (a) Within ten calendar days of contract execution, and prior to the commencement of work, the Contractor shall attend a preconstruction conference with representatives of the PHA, its Architect, and other interested parties convened by the PHA. The conference will serve to acquaint the participants with the general plan of the construction operation and all other requirements of the contract. The PHA will provide the Contractor with the date, time, and place of the conference.
- (b) The contractor shall begin work upon receipt of a written Notice to Proceed from the Contracting Officer or designee. The Contractor shall not begin work prior to receiving such notice.

#### 6. Construction Progress

- (a) The Contractor shall, within five days after the work commences on the contract or another period of time determined by the Contracting Officer, prepare and submit to the Contracting Officer for approval three copies of a practicable schedule showing the order in which the Contractor proposes to perform the work, and the dates on which the Contractor contemplates starting and completing the several salient features of the work (including acquiring labor, materials, and equipment). The schedule shall be in the form of a progress chart of suitable scale to indicate appropriately the percentage of work scheduled for completion by any given date during the period. If the Contractor fails to submit a schedule within the time prescribed, the Contracting Officer may withhold approval of progress payments or take other remedies under the contract until the Contractor submits the required schedule.
- (b) The Contractor shall enter the actual progress on the chart as required by the Contracting Officer, and immediately deliver three copies of the annotated schedule to the Contracting Officer. If the Contracting Officer determines, upon the basis of inspection conducted pursuant to the clause entitled Inspection and Acceptance of Construction, herein that the Contractor is not meeting the approved schedule, the Contractor shall take steps necessary to improve its progress, including those that may be required by the Contracting Officer, without additional cost to the PHA. In this circumstance, the Contracting Officer may require the Contractor to increase the number of shifts, overtime operations, days of work, and/or the amount of construction plant, and to submit for approval any supplementary schedule or schedules in chart form as the Contracting Officer deems necessary to demonstrate how the approved rate of progress will be regained.
- (c) Failure of the Contractor to comply with the requirements of the Contracting Officer under this clause shall be grounds for a determination by the Contracting Officer that the Contractor is not prosecuting the work with sufficient diligence to ensure completion within the time specified in the Contract. Upon making this determination, the Contracting Officer may terminate the Contractor's right to proceed with the work, or any separable part of it, in accordance with the Default clause of this contract.

#### 7. Site Investigation and Conditions Affecting the Work

- (a) The Contractor acknowledges that it has taken steps reasonably necessary to ascertain the nature and location as to the general and local conditions which can affect the work or its cost, including but not limited to, (1) conditions bearing upon transportation, disposal, handling, and storage of materials; (2) the availability of labor, water, electric power, and roads; (3) uncertainties of weather, river stages, tides, or similar physical conditions at the site; (4) the conformation and conditions of the ground; and (5) the character of equipment and facilities needed preliminary to and during work performance. The Contractor also acknowledges that it has satisfied itself as to the character, quality, and quantity of surface and subsurface materials or obstacles to be encountered insofar as this information is

reasonably ascertainable from an inspection of the site, including all exploratory work done by the PHA, as well as from the drawings and specifications made a part of this contract. Any failure of the Contractor to take the actions described and acknowledged in this paragraph will not relieve the Contractor from responsibility for estimating properly the difficulty and cost of successfully performing the work, or for proceeding to successfully perform the work without additional expense to the PHA.

(b) The PHA assumes no responsibility for any conclusions or interpretations made by the Contractor based on the information made available by the PHA. Nor does the PHA assume responsibility for any understanding reached or representation made concerning conditions which can affect the work by any of its officers or agents before the execution of this contract, unless that understanding or representation is expressly stated in this contract.

## 8. Differing Site Conditions

(a) The Contractor shall promptly, and before the conditions are disturbed, give a written notice to the Contracting Officer of (1) subsurface or latent physical conditions at the site which differ materially from those indicated in this contract, or (2) unknown physical conditions at the site(s), of an unusual nature, which differ materially from those ordinarily encountered and generally recognized as inhering in work of the character provided for in the contract.

(b) The Contracting Officer shall investigate the site conditions promptly after receiving the notice. Work shall not proceed at the affected site, except at the Contractor's risk, until the Contracting Officer has provided written instructions to the Contractor. If the conditions do materially so differ and cause an increase or decrease in the Contractor's cost of, or the time required for, performing any part of the work under this contract, whether or not changed as a result of the conditions, the Contractor shall file a claim in writing to the PHA within ten days after receipt of such instructions and, in any event, before proceeding with the work. An equitable adjustment in the contract price, the delivery schedule, or both shall be made under this clause and the contract modified in writing accordingly.

(c) No request by the Contractor for an equitable adjustment to the contract under this clause shall be allowed, unless the Contractor has given the written notice required; provided, that the time prescribed in (a) above for giving written notice may be extended by the Contracting Officer.

(d) No request by the Contractor for an equitable adjustment to the contract for differing site conditions shall be allowed if made after final payment under this contract.

## 9. Specifications and Drawings for Construction

(a) The Contractor shall keep on the work site a copy of the drawings and specifications and shall at all times give the Contracting Officer access thereto. Anything mentioned in the specifications and not shown on the drawings, or shown on the drawings and not mentioned in the specifications, shall be of like effect as if shown or mentioned in both. In case of difference between drawings and specifications, the specifications shall govern. In case of discrepancy in the figures, in the drawings, or in the specifications, the matter shall be

promptly submitted to the Contracting Officer, who shall promptly make a determination in writing. Any adjustment by the Contractor without such a determination shall be at its own risk and expense. The Contracting Officer shall furnish from time to time such detailed drawings and other information as considered necessary, unless otherwise provided.

(b) Wherever in the specifications or upon the drawings the words "directed", "required", "ordered", "designated", "prescribed", or words of like import are used, it shall be understood that the "direction", "requirement", "order", "designation", or "prescription", of the Contracting Officer is intended and similarly the words "approved", "acceptable", "satisfactory", or words of like import shall mean "approved by", or "acceptable to", or "satisfactory to" the Contracting Officer, unless otherwise expressly stated.

(c) Where "as shown" "as indicated", "as detailed", or words of similar import are used, it shall be understood that the reference is made to the drawings accompanying this contract unless stated otherwise. The word "provided" as used herein shall be understood to mean "provide complete in place" that is "furnished and installed".

(d) "Shop drawings" means drawings, submitted to the PHA by the Contractor, subcontractor, or any lower tier subcontractor, showing in detail (1) the proposed fabrication and assembly of structural elements and (2) the installation (i.e., form, fit, and attachment details) of materials of equipment. It includes drawings, diagrams, layouts, schematics, descriptive literature, illustrations, schedules, performance and test data, and similar materials furnished by the Contractor to explain in detail specific portions of the work required by the contract. The PHA may duplicate, use, and disclose in any manner and for any purpose shop drawings delivered under this contract.

(e) If this contract requires shop drawings, the Contractor shall coordinate all such drawings, and review them for accuracy, completeness, and compliance with other contract requirements and shall indicate its approval thereon as evidence of such coordination and review. Shop drawings submitted to the Contracting Officer without evidence of the Contractor's approval may be returned for resubmission. The Contracting Officer will indicate an approval or disapproval of the shop drawings and if not approved as submitted shall indicate the PHA's reasons therefore. Any work done before such approval shall be at the Contractor's risk. Approval by the Contracting Officer shall not relieve the Contractor from responsibility for any errors or omissions in such drawings, nor from responsibility for complying with the requirements of this contract, except with respect to variations described and approved in accordance with (f) below.

(f) If shop drawings show variations from the contract requirements, the Contractor shall describe such variations in writing, separate from the drawings, at the time of submission. If the Architect approves any such variation and the Contracting Officer concurs, the Contracting Officer shall issue an appropriate modification to the contract, except that, if the variation is minor or does not involve a change in price or in time of performance, a modification need not be issued.

(g) It shall be the responsibility of the Contractor to make timely requests of the PHA for such large scale and full size drawings, color schemes, and other additional information, not already in his possession, which shall be



required in the planning and production of the work. Such requests may be submitted as the need arises, but each such request shall be filed in ample time to permit appropriate action to be taken by all parties involved so as to avoid delay.

- (h) The Contractor shall submit to the Contracting Officer for approval four copies (unless otherwise indicated) of all shop drawings as called for under the various headings of these specifications. Three sets (unless otherwise indicated) of all shop drawings, will be retained by the PHA and one set will be returned to the Contractor. As required by the Contracting Officer, the Contractor, upon completing the work under this contract, shall furnish a complete set of all shop drawings as finally approved. These drawings shall show all changes and revisions made up to the time the work is completed and accepted.
- (i) This clause shall be included in all subcontracts at any tier. It shall be the responsibility of the Contractor to ensure that all shop drawings prepared by subcontractors are submitted to the Contracting Officer.

#### 10. As-Built Drawings

- (a) "As-built drawings," as used in this clause, means drawings submitted by the Contractor or subcontractor at any tier to show the construction of a particular structure or work as actually completed under the contract. "As-built drawings" shall be synonymous with "Record drawings."
- (b) As required by the Contracting Officer, the Contractor shall provide the Contracting Officer accurate information to be used in the preparation of permanent as-built drawings. For this purpose, the Contractor shall record on one set of contract drawings all changes from the installations originally indicated, and record final locations of underground lines by depth from finish grade and by accurate horizontal offset distances to permanent surface improvements such as buildings, curbs, or edges of walks.
- (c) This clause shall be included in all subcontracts at any tier. It shall be the responsibility of the Contractor to ensure that all as-built drawings prepared by subcontractors are submitted to the Contracting Officer.

#### 11. Material and Workmanship

- (a) All equipment, material, and articles furnished under this contract shall be new and of the most suitable grade for the purpose intended, unless otherwise specifically provided in this contract. References in the contract to equipment, material, articles, or patented processes by trade name, make, or catalog number, shall be regarded as establishing a standard of quality and shall not be construed as limiting competition. The Contractor may, at its option, use any equipment, material, article, or process that, in the judgment of, and as approved by the Contracting Officer, is equal to that named in the specifications, unless otherwise specifically provided in this contract.
- (b) Approval of equipment and materials.
- (1) The Contractor shall obtain the Contracting Officer's approval of the machinery and mechanical and other equipment to be incorporated into the work. When requesting approval, the Contractor shall furnish to the Contracting Officer the name of the manufacturer, the model number, and other information concerning the performance, capacity, nature, and rating of the

machinery and mechanical and other equipment. When required by this contract or by the Contracting Officer, the Contractor shall also obtain the Contracting Officer's approval of the material or articles which the Contractor contemplates incorporating into the work. When requesting approval, the Contractor shall provide full information concerning the material or articles. Machinery, equipment, material, and articles that do not have the required approval shall be installed or used at the risk of subsequent rejection.

- (2) When required by the specifications or the Contracting Officer, the Contractor shall submit appropriately marked samples (and certificates related to them) for approval at the Contractor's expense, with all shipping charges prepaid. The Contractor shall label, or otherwise properly mark on the container, the material or product represented, its place of origin, the name of the producer, the Contractor's name, and the identification of the construction project for which the material or product is intended to be used.
- (3) Certificates shall be submitted in triplicate, describing each sample submitted for approval and certifying that the material, equipment or accessory complies with contract requirements. The certificates shall include the name and brand of the product, name of manufacturer, and the location where produced.
- (4) Approval of a sample shall not constitute a waiver of the PHA right to demand full compliance with contract requirements. Materials, equipment and accessories may be rejected for cause even though samples have been approved.
- (5) Wherever materials are required to comply with recognized standards or specifications, such specifications shall be accepted as establishing the technical qualities and testing methods, but shall not govern the number of tests required to be made nor modify other contract requirements. The Contracting Officer may require laboratory test reports on items submitted for approval or may approve materials on the basis of data submitted in certificates with samples. Check tests will be made on materials delivered for use only as frequently as the Contracting Officer determines necessary to insure compliance of materials with the specifications. The Contractor will assume all costs of retesting materials which fail to meet contract requirements and/or testing materials offered in substitution for those found deficient.
- (6) After approval, samples will be kept in the Project office until completion of work. They may be built into the work after a substantial quantity of the materials they represent has been built in and accepted.
- (c) Requirements concerning lead-based paint. The Contractor shall comply with the requirements concerning lead-based paint contained in the Lead-Based Paint Poisoning Prevention Act (42 U.S.C. 4821-4846) as implemented by 24 CFR Part 35.

#### 12. Permits and Codes

- (a) The Contractor shall give all notices and comply with all applicable laws, ordinances, codes, rules and regulations. Notwithstanding the requirement of the Contractor to comply with the drawings and specifications in the contract, all work installed shall comply with all applicable codes and regulations as amended by any

waivers. Before installing the work, the Contractor shall examine the drawings and the specifications for compliance with applicable codes and regulations bearing on the work and shall immediately report any discrepancy it may discover to the Contracting Officer.

Where the requirements of the drawings and specifications fail to comply with the applicable code or regulation, the Contracting Officer shall modify the contract by change order pursuant to the clause entitled Changes herein to conform to the code or regulation.

- (b) The Contractor shall secure and pay for all permits, fees, and licenses necessary for the proper execution and completion of the work. Where the PHA can arrange for the issuance of all or part of these permits, fees and licenses, without cost to the Contractor, the contract amount shall be reduced accordingly.

### 13. Health, Safety, and Accident Prevention

(a) In performing this contract, the Contractor shall:

- (1) Ensure that no laborer or mechanic shall be required to work in surroundings or under working conditions which are unsanitary, hazardous, or dangerous to his/her health and/or safety as determined under construction safety and health standards promulgated by the Secretary of Labor by regulation;
- (2) Protect the lives, health, and safety of other persons;
- (3) Prevent damage to property, materials, supplies, and equipment; and,
- (4) Avoid work interruptions.

(b) For these purposes, the Contractor shall:

- (1) Comply with regulations and standards issued by the Secretary of Labor at 29 CFR Part 1926. Failure to comply may result in imposition of sanctions pursuant to the Contract Work Hours and Safety Standards Act (Public Law 91-54, 83 Stat. 96), 40 U.S.C. 3701 et seq.; and
- (2) Include the terms of this clause in every subcontract so that such terms will be binding on each subcontractor.

(c) The Contractor shall maintain an accurate record of exposure data on all accidents incident to work performed under this contract resulting in death, traumatic injury, occupational disease, or damage to property, materials, supplies, or equipment, and shall report this data in the manner prescribed by 29 CFR Part 1904.

(d) The Contracting Officer shall notify the Contractor of any noncompliance with these requirements and of the corrective action required. This notice, when delivered to the Contractor or the Contractor's representative at the site of the work, shall be deemed sufficient notice of the noncompliance and corrective action required. After receiving the notice, the Contractor shall immediately take corrective action. If the Contractor fails or refuses to take corrective action promptly, the Contracting Officer may issue an order stopping all or part of the work until satisfactory corrective action has been taken. The Contractor shall not base any claim or request for equitable adjustment for additional time or money on any stop order issued under these circumstances.

(e) The Contractor shall be responsible for its subcontractors' compliance with the provisions of this clause. The Contractor shall take such action with respect to any subcontract as the PHA, the Secretary of Housing and Urban Development, or the Secretary of Labor shall direct as a means of enforcing such provisions.

### 14. Temporary Heating

The Contractor shall provide and pay for temporary heating, covering, and enclosures necessary to properly protect all work and materials against damage by dampness and cold, to dry out the work, and to facilitate the completion of the work. Any permanent heating equipment used shall be turned over to the PHA in the condition and at the time required by the specifications.

### 15. Availability and Use of Utility Services

(a) The PHA shall make all reasonably required amounts of utilities available to the Contractor from existing outlets and supplies, as specified in the contract. Unless otherwise provided in the contract, the amount of each utility service consumed shall be charged to or paid for by the Contractor at prevailing rates charged to the PHA or, where the utility is produced by the PHA, at reasonable rates determined by the Contracting Officer. The Contractor shall carefully conserve any utilities furnished without charge.

(b) The Contractor, at its expense and in a manner satisfactory to the Contracting Officer, shall install and maintain all necessary temporary connections and distribution lines, and all meters required to measure the amount of each utility used for the purpose of determining charges. Before final acceptance of the work by the PHA, the Contractor shall remove all the temporary connections, distribution lines, meters, and associated paraphernalia.

### 16. Protection of Existing Vegetation, Structures, Equipment, Utilities, and Improvements

(a) The Contractor shall preserve and protect all structures, equipment, and vegetation (such as trees, shrubs, and grass) on or adjacent to the work site, which are not to be removed under this contract, and which do not unreasonably interfere with the work required under this contract.

(b) The Contractor shall only remove trees when specifically authorized to do so, and shall avoid damaging vegetation that will remain in place. If any limbs or branches of trees are broken during performance of this contract, or by the careless operation of equipment, or by workmen, the Contractor shall trim those limbs or branches with a clean cut and paint the cut with a tree-pruning compound as directed by the Contracting Officer.

(c) The Contractor shall protect from damage all existing improvements and utilities (1) at or near the work site and (2) on adjacent property of a third party, the locations of which are made known to or should be known by the Contractor. Prior to disturbing the ground at the construction site, the Contractor shall ensure that all underground utility lines are clearly marked.

(d) The Contractor shall shore up, brace, underpin, secure, and protect as necessary all foundations and other parts of existing structures adjacent to, adjoining, and in the vicinity of the site, which may be affected by the excavations or other operations connected with the construction of the project.

(e) Any equipment temporarily removed as a result of work under this contract shall be protected, cleaned, and replaced in the same condition as at the time of award of this contract.

- (f) New work which connects to existing work shall correspond in all respects with that to which it connects and/or be similar to existing work unless otherwise required by the specifications.
- (g) No structural members shall be altered or in any way weakened without the written authorization of the Contracting Officer, unless such work is clearly specified in the plans or specifications.
- (h) If the removal of the existing work exposes discolored or unfinished surfaces, or work out of alignment, such surfaces shall be refinished, or the material replaced as necessary to make the continuous work uniform and harmonious. This, however, shall not be construed to require the refinishing or reconstruction of dissimilar finishes previously exposed, or finished surfaces in good condition, but in different planes or on different levels **Construction** when brought together by the removal of intervening work, unless such refinishing or reconstruction is specified in the plans or specifications.
- (i) The Contractor shall give all required notices to any adjoining or adjacent property owner or other party before the commencement of any work.
- (j) The Contractor shall indemnify and save harmless the PHA from any damages on account of settlement or the loss of lateral support of adjoining property, any damages from changes in topography affecting drainage, and from all loss or expense and all damages for which the PHA may become liable in consequence of such injury or damage to adjoining and adjacent structures and their premises.
- (k) The Contractor shall repair any damage to vegetation, structures, equipment, utilities, or improvements, including those that are the property of a third party, resulting from failure to comply with the requirements of this contract or failure to exercise reasonable care in performing the work. If the Contractor fails or refuses to repair the damage promptly, the Contracting Officer may have the necessary work performed and charge the cost to the Contractor.

## 17. Temporary Buildings and Transportation of Materials

- (a) Temporary buildings (e.g., storage sheds, shops, offices, sanitary facilities) and utilities may be erected by the Contractor only with the approval of the Contracting Officer and shall be built with labor and materials furnished by the Contractor without expense to the PHA. The temporary buildings and utilities shall remain the property of the Contractor and shall be removed by the Contractor at its expense upon completion of the work. With the written consent of the Contracting Officer, the buildings and utilities may be abandoned and need not be removed.
- (b) The Contractor shall, as directed by the Contracting Officer, use only established roadways, or use temporary roadways constructed by the Contractor when and as authorized by the Contracting Officer. When materials are transported in prosecuting the work, vehicles shall not be loaded beyond the loading capacity recommended by the manufacturer of the vehicle or prescribed by any federal, state, or local law or regulation. When it is necessary to cross curbs or sidewalks, the Contractor shall protect them from damage. The Contractor shall repair or pay for the repair of any damaged curbs, sidewalks, or roads.

## 18. Clean Air and Water

The contractor shall comply with the Clean Air Act, as amended, 42 USC 7401 et seq., the Federal Water Pollution Control Water Act, as amended, 33 U.S.C. 1251 et seq., and standards issued pursuant thereto in the facilities in which this contract is to be performed.

## 19. Energy Efficiency

The Contractor shall comply with mandatory standards and policies relating to energy efficiency which are contained in the energy conservation plan issued in compliance with the Energy Policy and Conservation Act (Pub.L. 94-163) for the State in which the work under the contract is performed.

## 20. Inspection and Acceptance of

- (a) Definitions. As used in this clause -
- (1) "Acceptance" means the act of an authorized representative of the PHA by which the PHA approves and assumes ownership of the work performed under this contract. Acceptance may be partial or complete.
- (2) "Inspection" means examining and testing the work performed under the contract (including, when appropriate, raw materials, equipment, components, and intermediate assemblies) to determine whether it conforms to contract requirements.
- (3) "Testing" means that element of inspection that determines the properties or elements, including functional operation of materials, equipment, or their components, by the application of established scientific principles and procedures.
- (b) The Contractor shall maintain an adequate inspection system and perform such inspections as will ensure that the work performed under the contract conforms to contract requirements. All work is subject to PHA inspection and test at all places and at all reasonable times before acceptance to ensure strict compliance with the terms of the contract.
- (c) PHA inspections and tests are for the sole benefit of the PHA and do not: (1) relieve the Contractor of responsibility for providing adequate quality control measures; (2) relieve the Contractor of responsibility for loss or damage of the material before acceptance; (3) constitute or imply acceptance; or, (4) affect the continuing rights of the PHA after acceptance of the completed work under paragraph (j) below.
- (d) The presence or absence of the PHA inspector does not relieve the Contractor from any contract requirement, nor is the inspector authorized to change any term or condition of the specifications without the Contracting Officer's written authorization. All instructions and approvals with respect to the work shall be given to the Contractor by the Contracting Officer.
- (e) The Contractor shall promptly furnish, without additional charge, all facilities, labor, and material reasonably needed for performing such safe and convenient inspections and tests as may be required by the Contracting Officer. The PHA may charge to the Contractor any additional cost of inspection or test when work is not ready at the time specified by the Contractor for inspection or test, or when prior rejection makes reinspection or retest necessary. The PHA shall perform all inspections and tests in a manner that will not unnecessarily delay the work. Special, full size, and performance tests shall be performed as described in the contract.

- (f) The PHA may conduct routine inspections of the construction site on a daily basis.
- (g) The Contractor shall, without charge, replace or correct work found by the PHA not to conform to contract requirements, unless the PHA decides that it is in its interest to accept the work with an appropriate adjustment in contract price. The Contractor shall promptly segregate and remove rejected material from the premises.
- (h) If the Contractor does not promptly replace or correct rejected work, the PHA may (1) by contract or otherwise, replace or correct the work and charge the cost to the Contractor, or (2) terminate for default the Contractor's right to proceed.
- (i) If any work requiring inspection is covered up without approval of the PHA, it must, if requested by the Contracting Officer, be uncovered at the expense of the Contractor. If at any time before final acceptance of the entire work, the **Construction PHA** considers it necessary or advisable, to examine work already completed by removing or tearing it out, the Contractor, shall on request, promptly furnish all necessary facilities, labor, and material. If such work is found to be defective or nonconforming in any material respect due to the fault of the Contractor or its subcontractors, the Contractor shall defray all the expenses of the examination and of satisfactory reconstruction. If, however, such work is found to meet the requirements of the contract, the Contracting Officer shall make an equitable adjustment to cover the cost of the examination and reconstruction, including, if completion of the work was thereby delayed, an extension of time.
- (j) The Contractor shall notify the Contracting Officer, in writing, as to the date when in its opinion all or a designated portion of the work will be substantially completed and ready for inspection. If the Architect determines that the state of preparedness is as represented, the PHA will promptly arrange for the inspection. Unless otherwise specified in the contract, the PHA shall accept, as soon as practicable after completion and inspection, all work required by the contract or that portion of the work the Contracting Officer determines and designates can be accepted separately. Acceptance shall be final and conclusive except for latent defects, fraud, gross mistakes amounting to fraud, or the PHA's right under any warranty or guarantee.

## 21. Use and Possession Prior to Completion

- (a) The PHA shall have the right to take possession of or use any completed or partially completed part of the work. Before taking possession of or using any work, the Contracting Officer shall furnish the Contractor a list of items of work remaining to be performed or corrected on those portions of the work that the PHA intends to take possession of or use. However, failure of the Contracting Officer to list any item of work shall not relieve the Contractor of responsibility for complying with the terms of the contract. The PHA's possession or use shall not be deemed an acceptance of any work under the contract.
- (b) While the PHA has such possession or use, the Contractor shall be relieved of the responsibility for (1) the loss of or damage to the work resulting from the PHA's possession or use, notwithstanding the terms of the clause entitled Permits and Codes herein; (2) all maintenance costs on the areas occupied; and, (3) furnishing heat, light, power, and water used in the areas

occupied without proper remuneration therefore. If prior possession or use by the PHA delays the progress of the work or causes additional expense to the Contractor, an equitable adjustment shall be made in the contract price or the time of completion, and the contract shall be modified in writing accordingly.

## 22. Warranty of Title

The Contractor warrants good title to all materials, supplies, and equipment incorporated in the work and agrees to deliver the premises together with all improvements thereon free from any claims, liens or charges, and agrees further that neither it nor any other person, firm or corporation shall have any right to a lien upon the premises or anything appurtenant thereto.

## 23. Warranty of

- (a) In addition to any other warranties in this contract, the Contractor warrants, except as provided in paragraph (j) of this clause, that work performed under this contract conforms to the contract requirements and is free of any defect in equipment, material, or workmanship performed by the Contractor or any subcontractor or supplier at any tier. This warranty shall continue for a period of \_\_\_\_\_ (one year unless otherwise indicated) from the date of final acceptance of the work. If the PHA takes possession of any part of the work before final acceptance, this warranty shall continue for a period of (one year unless otherwise indicated) from the date that the PHA takes possession.
- (b) The Contractor shall remedy, at the Contractor's expense, any failure to conform, or any defect. In addition, the Contractor shall remedy, at the Contractor's expense, any damage to PHA-owned or controlled real or personal property when the damage is the result of—
  - (1) The Contractor's failure to conform to contract requirements; or
  - (2) Any defects of equipment, material, workmanship or design furnished by the Contractor.
- (c) The Contractor shall restore any work damaged in fulfilling the terms and conditions of this clause. The Contractor's warranty with respect to work repaired or replaced will run for (one year unless otherwise indicated) from the date of repair or replacement.
- (d) The Contracting Officer shall notify the Contractor, in writing, within a reasonable time after the discovery of any failure, defect or damage.
- (e) If the Contractor fails to remedy any failure, defect, or damage within a reasonable time after receipt of notice, the PHA shall have the right to replace, repair or otherwise remedy the failure, defect, or damage at the Contractor's expense.
- (f) With respect to all warranties, express or implied, from subcontractors, manufacturers, or suppliers for work performed and materials furnished under this contract, the Contractor shall:
  - (1) Obtain all warranties that would be given in normal commercial practice;
  - (2) Require all warranties to be executed in writing, for the benefit of the PHA; and,
  - (3) Enforce all warranties for the benefit of the PHA.
- (g) In the event the Contractor's warranty under paragraph (a) of this clause has expired, the PHA may bring suit at its own expense to enforce a subcontractor's, manufacturer's or supplier's warranty.



- (h) Unless a defect is caused by the negligence of the Contractor or subcontractor or supplier at any tier, the Contractor shall not be liable for the repair of any defect of material or design furnished by the PHA nor for the repair of any damage that results from any defect in PHA furnished material or design.
- (i) Notwithstanding any provisions herein to the contrary, the establishment of the time periods in paragraphs (a) and (c) above relate only to the specific obligation of the Contractor to correct the work, and have no relationship to the time within which its obligation to comply with the contract may be sought to be enforced, nor to the time within which proceedings may be commenced to establish the Contractor's liability with respect to its obligation other than specifically to correct the work.
- (j) This warranty shall not limit the PHA's rights under the Inspection and Acceptance of Construction clause of this contract with respect to latent defects, gross mistakes or fraud.

**24. Prohibition Against Liens**

The Contractor is prohibited from placing a lien on the PHA's property. This prohibition shall apply to all subcontractors at any tier and all materials suppliers.

**Administrative Requirements**

**25. Contract Period**

this contract within \_\_\_\_\_ calendar days of the effective date of the contract, or within the time schedule established in the notice to proceed issued by the Contracting Officer.

**26. Order of Provisions**

accordance with the terms and conditions of the

In the event of a conflict between these General Conditions and the Specifications, the General Conditions shall prevail. In the event of a conflict between the contract and any applicable state or local law or regulation, the state or local law or regulation shall prevail; provided that such state or local law or regulation does not conflict with, or is less restrictive than applicable federal law, regulation, or Executive Order. In the event of such a conflict, applicable federal law, regulation, and Executive Order shall prevail.

**27. Payments**

retain ten (10) percent of the amount of progress

- (a) The PHA shall pay the Contractor the price as provided in this contract.
- (b) The PHA shall make progress payments approximately every 30 days as the work proceeds, on estimates of work accomplished which meets the standards of quality established under the contract, as approved by the Contracting Officer. The PHA may, subject to written determination and approval of the Contracting Officer, make more frequent payments to contractors which are qualified small businesses.
- (c) Before the first progress payment under this contract, the Contractor shall furnish, in such detail as requested by the Contracting Officer, a breakdown of the total contract price showing the amount included therein for each principal category of the work, which shall substantiate the payment amount requested in order to provide a

basis for determining progress payments. The breakdown shall be approved by the Contracting Officer and must be acceptable to HUD. If the contract covers more than one project, the Contractor shall furnish a separate breakdown for each. The values and quantities employed in making up this breakdown are for determining the amount of progress payments and shall not be construed as a basis for additions to or deductions from the contract price. The Contractor shall prorate its overhead and profit over the construction period of the contract.

- (d) The Contractor shall submit, on forms provided by the PHA, periodic estimates showing the value of the work performed during each period based upon the approved submitted not later than \_\_\_\_\_ days in advance of the date set for payment and are subject to correction and revision as required. The estimates must be approved by the Contracting Officer with the concurrence of the Architect prior to payment. If the contract covers more than one project, the Contractor shall furnish a separate progress payment estimate for each.
- (e) Along with each request for progress payments and the required estimates, the Contractor shall furnish the following certification, or payment shall not be made: I hereby certify, to the best of my knowledge and belief, that:

- (1) The amounts requested are only for performance in accordance with the specifications, terms, and conditions of the contract;
- (2) Payments to subcontractors and suppliers have been made from previous payments received under the contract, and timely payments will be made from the proceeds of the payment covered by this certification, in accordance with subcontract agreements; and,
- (3) This request for progress payments does not include any amounts which the prime contractor intends to withhold or retain from a subcontractor or supplier in subcontract.

**Name:**

Title:

Date:

- (f) Except as otherwise provided in State law, the PHA shall payments until completion and acceptance of all work under the contract; except, that if upon completion of 50 percent of the work, the Contracting Officer, after consulting with the Architect, determines that the Contractor's performance and progress are satisfactory, the PHA may make the remaining payments in full for the work subsequently completed. If the Contracting Officer subsequently determines that the Contractor's performance and progress are unsatisfactory, the PHA shall reinstate the ten (10) percent (or other percentage as provided in State law) retainage until such time as the Contracting Officer determines that performance and progress are satisfactory.
- (g) The Contracting Officer may authorize material delivered on the site and preparatory work done to be taken into consideration when computing progress payments.

Material delivered to the Contractor at locations other than the site may also be taken into consideration if the Contractor furnishes satisfactory evidence that (1) it has acquired title to such material; (2) the material is properly stored in a bonded warehouse, storage yard, or similar suitable place as may be approved by the Contracting Officer; (3) the material is insured to cover its full value; and (4) the material will be used to perform this contract. Before any progress payment which includes delivered material is made, the Contractor shall furnish such documentation as the Contracting Officer may require to assure the protection of the PHA's interest in such materials. The Contractor shall remain responsible for such stored material notwithstanding the transfer of title to the PHA.

- (h) All material and work covered by progress payments made shall, at the time of payment become the sole property of the PHA, but this shall not be construed as (1) relieving the Contractor from the sole responsibility for all material and work upon which payments have been made or the restoration of any damaged work; or, (2) waiving the right of the PHA to require the fulfillment of all of the terms of the contract. In the event the work of the Contractor has been damaged by other contractors or persons other than employees of the PHA in the course of their employment, the Contractor shall restore such damaged work without cost to the PHA and to seek redress for its damage only from those who directly caused it.
- (i) The PHA shall make the final payment due the Contractor under this contract after (1) completion and final acceptance of all work; and (2) presentation of release of all claims against the PHA arising by virtue of this contract, other than claims, in stated amounts, that the Contractor has specifically excepted from the operation of the release. Each such exception shall embrace no more than one claim, the basis and scope of which shall be clearly defined. The amounts for such excepted claims shall not be included in the request for final payment. A release may also be required of the assignee if the Contractor's claim to amounts payable under this contract has been assigned.
- (j) Prior to making any payment, the Contracting Officer may require the Contractor to furnish receipts or other evidence of payment from all persons performing work and supplying material to the Contractor, if the Contracting Officer determines such evidence is necessary to substantiate claimed costs.
- (k) The PHA shall not; (1) determine or adjust any claims for payment or disputes arising there under between the Contractor and its subcontractors or material suppliers; or, (2) withhold any moneys for the protection of the subcontractors or material suppliers. The failure or refusal of the PHA to withhold moneys from the Contractor shall in no wise impair the obligations of any surety or sureties under any bonds furnished under this contract.

## 28. Contract Modifications

- (a) Only the Contracting Officer has authority to modify any term or condition of this contract. Any contract modification shall be authorized in writing.
- (b) The Contracting Officer may modify the contract unilaterally (1) pursuant to a specific authorization stated in a contract clause (e.g., Changes); or (2) for administrative matters which do not change the rights or

responsibilities of the parties (e.g., change in the PHA address). All other contract modifications shall be in the form of supplemental agreements signed by the Contractor and the Contracting Officer.

- (c) When a proposed modification requires the approval of HUD prior to its issuance (e.g., a change order that exceeds the PHA's approved threshold), such modification shall not be effective until the required approval is received by the PHA.

## 29. Changes

- (a) The Contracting Officer may, at any time, without notice to the sureties, by written order designated or indicated to be a change order, make changes in the work within the general scope of the contract including changes:
  - (1) In the specifications (including drawings and designs);
  - (2) In the method or manner of performance of the work;
  - (3) PHA-furnished facilities, equipment, materials, services, or site; or,
  - (4) Directing the acceleration in the performance of the work.
- (b) Any other written order or oral order (which, as used in this paragraph (b), includes direction, instruction, interpretation, or determination) from the Contracting Officer that causes a change shall be treated as a change order under this clause; provided, that the Contractor gives the Contracting Officer written notice stating (1) the date, circumstances and source of the order and (2) that the Contractor regards the order as a change order.
- (c) Except as provided in this clause, no order, statement or conduct of the Contracting Officer shall be treated as a change under this clause or entitle the Contractor to an equitable adjustment.
- (d) If any change under this clause causes an increase or decrease in the Contractor's cost of, or the time required for the performance of any part of the work under this contract, whether or not changed by any such order, the Contracting Officer shall make an equitable adjustment and modify the contract in writing. However, except for a adjustment based on defective specifications, no proposal for any change under paragraph (b) above shall be allowed for any costs incurred more than 20 days (5 days for oral orders) before the Contractor gives written notice as required. In the case of defective specifications for which the PHA is responsible, the equitable adjustment shall include any increased cost reasonably incurred by the Contractor in attempting to comply with the defective specifications.
- (e) The Contractor must assert its right to an adjustment under this clause within 30 days after (1) receipt of a written change order under paragraph (a) of this clause, or (2) the furnishing of a written notice under paragraph (b) of this clause, by submitting a written statement describing the general nature and the amount of the proposal. If the facts justify it, the Contracting Officer may extend the period for submission. The proposal may be included in the notice required under paragraph (b) above. No proposal by the Contractor for an equitable adjustment shall be allowed if asserted after final payment under this contract.
- (f) The Contractor's written proposal for equitable adjustment shall be submitted in the form of a lump sum proposal supported with an itemized breakdown of all increases and decreases in the contract in at least the following details:

- (1) Direct Costs. Materials (list individual items, the quantity and unit cost of each, and the aggregate cost); Transportation and delivery costs associated with materials; Labor breakdowns by hours or unit costs (identified with specific work to be performed); Construction equipment exclusively necessary for the change; Costs of preparation and/ or revision to shop drawings resulting from the change; Worker's Compensation and Public Liability Insurance; Employment taxes under FICA and FUTA; and, Bond Costs when size of change warrants revision.
- (2) Indirect Costs. Indirect costs may include overhead, general and administrative expenses, and fringe benefits not normally treated as direct costs.
- (3) Profit. The amount of profit shall be negotiated and may vary according to the nature, extent, and complexity of the work required by the change. The allowability of the direct and indirect costs shall be determined in accordance with the Contract Cost Principles and Procedures for Commercial Firms in Part 31 of the Federal Acquisition Regulation (48 CFR 1-31), as implemented by HUD Handbook 2210.18, in effect on the date of this contract. The Contractor shall not be allowed a profit on the profit received by any subcontractor. Equitable adjustments for deleted work shall include a credit for profit and may include a credit for indirect costs. On proposals covering both increases and decreases in the amount of the contract, the application of indirect costs and profit shall be on the net-change in direct costs for the Contractor or subcontractor performing the work.
- (g) The Contractor shall include in the proposal its request for time extension (if any), and shall include sufficient information and dates to demonstrate whether and to what extent the change will delay the completion of the contract in its entirety.
- (h) The Contracting Officer shall act on proposals within 30 days after their receipt, or notify the Contractor of the date when such action will be taken.
- (i) Failure to reach an agreement on any proposal shall be a dispute under the clause entitled Disputes herein. Nothing in this clause, however, shall excuse the Contractor from proceeding with the contract as changed.
- (j) Except in an emergency endangering life or property, no change shall be made by the Contractor without a prior order from the Contracting Officer.

### 30. Suspension of Work

- (a) The Contracting Officer may order the Contractor in writing to suspend, delay, or interrupt all or any part of the work of this contract for the period of time that the Contracting Officer determines appropriate for the convenience of the PHA.
- (b) If the performance of all or any part of the work is, for an unreasonable period of time, suspended, delayed, or interrupted (1) by an act of the Contracting Officer in the administration of this contract, or (2) by the Contracting Officer's failure to act within the time specified (or within a reasonable time if not specified) in this contract an adjustment shall be made for any increase in the cost of performance of the contract (excluding profit) necessarily caused by such unreasonable suspension, delay, or interruption and the contract modified in writing accordingly. However, no adjustment shall be made under this clause for any suspension, delay, or interruption to the extent that performance would have

- been so suspended, delayed, or interrupted by any other cause, including the fault or negligence of the Contractor or for which any equitable adjustment is provided for or excluded under any other provision of this contract.
- (c) A claim under this clause shall not be allowed (1) for any costs incurred more than 20 days before the Contractor shall have notified the Contracting Officer in writing of the act or failure to act involved (but this requirement shall not apply as to a claim resulting from a suspension order); and, (2) unless the claim, in an amount stated, is asserted in writing as soon as practicable after the termination of the suspension, delay, or interruption, but not later than the date of final payment under the contract.

### 31. Disputes

- (a) "Claim," as used in this clause, means a written demand or written assertion by one of the contracting parties seeking, as a matter of right, the payment of money in a sum certain, the adjustment or interpretation of contract terms, or other relief arising under or relating to the contract. A claim arising under the contract, unlike a claim relating to the contract, is a claim that can be resolved under a contract clause that provides for the relief sought by the claimant. A voucher, invoice, or other routine request for payment that is not in dispute when submitted is not a claim. The submission may be converted to a claim by complying with the requirements of this clause, if it is disputed either as to liability or amount or is not acted upon in a reasonable time.
- (b) Except for disputes arising under the clauses entitled Labor Standards - Davis Bacon and Related Acts, herein, all disputes arising under or relating to this contract, including any claims for damages for the alleged breach thereof which are not disposed of by agreement, shall be resolved under this clause.
- (c) All claims by the Contractor shall be made in writing and submitted to the Contracting Officer for a written decision. A claim by the PHA against the Contractor shall be subject to a written decision by the Contracting Officer.
- (d) The Contracting Officer shall, within 60 (unless otherwise indicated) days after receipt of the request, decide the claim or notify the Contractor of the date by which the decision will be made.
- (e) The Contracting Officer's decision shall be final unless the Contractor (1) appeals in writing to a higher level in the PHA in accordance with the PHA's policy and procedures, (2) refers the appeal to an independent mediator or arbitrator, or (3) files suit in a court of competent jurisdiction. Such appeal must be made within (30 unless otherwise indicated) days after receipt of the Contracting Officer's decision.
- (f) The Contractor shall proceed diligently with performance of this contract, pending final resolution of any request for relief, claim, appeal, or action arising under or relating to the contract, and comply with any decision of the Contracting Officer.

### 32. Default

- (a) If the Contractor refuses or fails to prosecute the work, or any separable part thereof, with the diligence that will insure its completion within the time specified in this contract, or any extension thereof, or fails to complete said work within this time, the Contracting Officer may, by written notice to the Contractor, terminate the right to

proceed with the work (or separable part of the work) that has been delayed. In this event, the PHA may take over the work and complete it, by contract or otherwise, and may take possession of and use any materials, equipment, and plant on the work site necessary for completing the work. The Contractor and its sureties shall be liable for any damage to the PHA resulting from the **Convenience** Contractor's refusal or failure to complete the work within the specified time, whether or not the Contractor's right to proceed with the work is terminated. This liability includes any increased costs incurred by the PHA in completing the work.

- (b) The Contractor's right to proceed shall not be terminated or the Contractor charged with damages under this clause if—
- (1) The delay in completing the work arises from unforeseeable causes beyond the control and without the fault or negligence of the Contractor. Examples of such causes include (i) acts of God, or of the public enemy, (ii) acts of the PHA or other governmental entity in either its sovereign or contractual capacity, (iii) acts of another contractor in the performance of a contract with the PHA, (iv) fires, (v) floods, (vi) epidemics, (vii) quarantine restrictions, (viii) strikes, (ix) freight embargoes, (x) unusually severe weather, or (xi) delays of subcontractors or suppliers at any tier arising from unforeseeable causes beyond the control and without the fault or negligence of both the Contractor and the subcontractors or suppliers; and
  - (2) The Contractor, within days (10 days unless otherwise indicated) from the beginning of such delay (unless extended by the Contracting Officer) notifies the Contracting Officer in writing of the causes of delay. The Contracting Officer shall ascertain the facts and the extent of the delay. If, in the judgment of the Contracting Officer, the findings of fact warrant such action, time for completing the work shall be extended by written modification to the contract. The findings of the Contracting Officer shall be reduced to a written decision which shall be subject to the provisions of the Disputes clause of this contract.
- (c) If, after termination of the Contractor's right to proceed, it is determined that the Contractor was not in default, or that the delay was excusable, the rights and obligations of the parties will be the same as if the termination had been for convenience of the PHA.

### 33. Liquidated Damages

- (a) If the Contractor fails to complete the work within the time specified in the contract, or any extension, as specified in the clause entitled Default of this contract, the Contractor shall pay to the PHA as liquidated damages, the sum of \$ \_\_\_\_\_ [Contracting Officer insert amount] for each day of delay. If different completion dates are specified in the contract for separate parts or stages of the work, the amount of liquidated damages shall be assessed on those parts or stages which are delayed. To the extent that the Contractor's delay or nonperformance is excused under another clause in this contract, liquidated damages shall not be due the PHA. The Contractor remains liable for damages caused other than by delay.
- (b) If the PHA terminates the Contractor's right to proceed, the resulting damage will consist of liquidated damages until such reasonable time as may be required for final

completion of the work together with any increased costs occasioned the PHA in completing the work.

- (c) If the PHA does not terminate the Contractor's right to proceed, the resulting damage will consist of liquidated damages until the work is completed or accepted.

### 34. Termination for

- (a) The Contracting Officer may terminate this contract in whole, or in part, whenever the Contracting Officer determines that such termination is in the best interest of the PHA. Any such termination shall be effected by delivery to the Contractor of a Notice of Termination specifying the extent to which the performance of the work under the contract is terminated, and the date upon which such termination becomes effective.
- (b) If the performance of the work is terminated, either in whole or in part, the PHA shall be liable to the Contractor for reasonable and proper costs resulting from such termination upon the receipt by the PHA of a properly presented claim setting out in detail: (1) the total cost of the work performed to date of termination less the total amount of contract payments made to the Contractor; (2) the cost (including reasonable profit) of settling and paying claims under subcontracts and material orders for work performed and materials and supplies delivered to the site, payment for which has not been made by the PHA to the Contractor or by the Contractor to the subcontractor or supplier; (3) the cost of preserving and protecting the work already performed until the PHA or assignee takes possession thereof or assumes responsibility therefore; (4) the actual or estimated cost of legal and accounting services reasonably necessary to prepare and present the termination claim to the PHA; and (5) an amount constituting a reasonable profit on the value of the work performed by the Contractor.
- (c) The Contracting Officer will act on the Contractor's claim within days (60 days unless otherwise indicated) of receipt of the Contractor's claim.
- (d) Any disputes with regard to this clause are expressly made subject to the provisions of the Disputes clause of this contract.

### 35. Assignment of Contract

The Contractor shall not assign or transfer any interest in this contract; except that claims for monies due or to become due from the PHA under the contract may be assigned to a bank, trust company, or other financial institution. Such assignments of claims shall only be made with the written concurrence of the Contracting Officer. If the Contractor is a partnership, this contract shall inure to the benefit of the surviving or remaining member(s) of such partnership as approved by the Contracting Officer.

### 36. Insurance

- (a) Before commencing work, the Contractor and each subcontractor shall furnish the PHA with certificates of insurance showing the following insurance is in force and will insure all operations under the Contract:
  - (1) Workers' Compensation, in accordance with state or Territorial Workers' Compensation laws.
  - (2) Commercial General Liability with a combined single limit for bodily injury and property damage of not less than \$ \_\_\_\_\_ [Contracting Officer insert amount]



per occurrence to protect the Contractor and each subcontractor against claims for bodily injury or death and damage to the property of others. This shall cover the use of all equipment, hoists, and vehicles on the site(s) not covered by Automobile Liability under (3) below. If the Contractor has a "claims made" policy, then the following additional requirements apply: the policy must provide a "retroactive date" which must be on or before the execution date of the Contract; and the extended reporting period may not be less than five years following the completion date of the Contract.

(3) Automobile Liability on owned and non-owned motor vehicles used on the site(s) or in connection therewith for a combined single limit for bodily injury and property damage of not less than \$ \_\_\_\_\_

[Contracting Officer insert amount] per occurrence.

(b) Before commencing work, the Contractor shall furnish the PHA with a certificate of insurance evidencing that Builder's Risk (fire and extended coverage) Insurance on all work in place and/or materials stored at the building site(s), including foundations and building equipment, is in force. The Builder's Risk Insurance shall be for the benefit of the Contractor and the PHA as their interests may appear and each shall be named in the policy or policies as an insured. The Contractor in installing equipment supplied by the PHA shall carry insurance on such equipment from the time the Contractor takes possession thereof until the Contract work is accepted by the PHA. The Builder's Risk Insurance need not be carried on excavations, piers, footings, or foundations until such time as work on the superstructure is started. It need not be carried on landscape work. Policies shall furnish coverage at all times for the full cash value of all completed construction, as well as materials in place and/or stored at the site(s), whether or not partial payment has been made by the PHA. The Contractor may terminate this insurance on buildings as of the date taken over for occupancy by the PHA. The Contractor is not required to carry Builder's Risk Insurance for modernization work which does not involve structural alterations or additions and where the PHA's existing fire and extended coverage policy can be endorsed to include such work.

(c) All insurance shall be carried with companies which are financially responsible and admitted to do business in the State in which the project is located. If any such insurance is due to expire during the construction period, the Contractor (including subcontractors, as applicable) shall not permit the coverage to lapse and shall furnish evidence of coverage to the Contracting Officer. All certificates of insurance, as evidence of coverage, shall provide that no coverage may be canceled or non-renewed by the insurance company until at least 30 days prior written notice has been given to the Contracting Officer.

### 37. Subcontracts

(a) Definitions. As used in this contract -

(1) "Subcontract" means any contract, purchase order, or other purchase agreement, including modifications and change orders to the foregoing, entered into by a subcontractor to furnish supplies, materials, equipment, and services for the performance of the prime contract or a subcontract.

(2) "Subcontractor" means any supplier, vendor, or firm that furnishes supplies, materials, equipment, or services to or for the Contractor or another subcontractor.

(b) The Contractor shall not enter into any subcontract with any subcontractor who has been temporarily denied participation in a HUD program or who has been suspended or debarred from participating in contracting programs by any agency of the United States Government or of the state in which the work under this contract is to be performed.

(c) The Contractor shall be as fully responsible for the acts or omissions of its subcontractors, and of persons either directly or indirectly employed by them as for the acts or omissions of persons directly employed by the Contractor.

(d) The Contractor shall insert appropriate clauses in all subcontracts to bind subcontractors to the terms and conditions of this contract insofar as they are applicable to the work of subcontractors.

(e) Nothing contained in this contract shall create any contractual relationship between any subcontractor and the PHA or between the subcontractor and HUD.

### 38. Subcontracting with Small and Minority Firms, Women's Business Enterprise, and Labor Surplus Area Firms

The Contractor shall take the following steps to ensure that, whenever possible, subcontracts are awarded to small business firms, minority firms, women's business enterprises, and labor surplus area firms:

- (a) Placing qualified small and minority businesses and women's business enterprises on solicitation lists;
- (b) Ensuring that small and minority businesses and women's business enterprises are solicited whenever they are potential sources;
- (c) Dividing total requirements, when economically feasible, into smaller tasks or quantities to permit maximum participation by small and minority businesses and women's business enterprises;
- (d) Establishing delivery schedules, where the requirements of the contract permit, which encourage participation by small and minority businesses and women's business enterprises; and
- (e) Using the services and assistance of the U.S. Small Business Administration, the Minority Business Development Agency of the U.S. Department of Commerce, and State and local governmental small business agencies.

### 39. Equal Employment Opportunity

During the performance of this contract, the Contractor/Seller agrees as follows:

(a) The Contractor/Seller shall not discriminate against any employee or applicant for employment because of race color, religion, sex, sexual orientation, gender identity, disability, or national origin.

(b) The Contractor/Seller shall take affirmative action to ensure that applicants are employed, and that employees are treated during employment without regard to their race, color, religion, sex, sexual orientation, gender identity, disability, or national origin. Such action shall include, but not be limited to, (1) employment, (2) upgrading demotion, (4) transfer, (5) recruitment or recruitment advertising, (6) layoff or termination, (7) rates of pay or other forms of compensation, and (8) selection for training, including apprenticeship

(c) The Contractor/Seller agrees to post in conspicuous places available to employees and applicants for employment the notices to be provided by the Contracting Officer setting forth the provisions of this nondiscrimination clause.

(d) The Contractor/Seller shall, in all solicitations or advertisements for employees placed by or on behalf of the Contractor/Seller, state that all qualified applicants will receive consideration for employment without regard to race, color, religion, sex, or national origin.

(e) The Contractor/Seller shall send, to each labor union or representative of workers with which it has a collective bargaining agreement or other contract or understanding, the notice to be provided by the Contracting Officer advising the labor union or workers' representative of the Contractor's commitments under this clause, and post copies of the notice in conspicuous places available to employees and applicants for employment.

(f) The Contractor/Seller shall comply with Executive Order 11246, as amended, and the rules, regulations, and orders of the Secretary of Labor.

(g) The Contractor/Seller shall furnish all information and reports required by Executive Order 11246, as amended, Section 503 of the Rehabilitation Act of 1973, as amended, and by rules, regulations, and orders of the Secretary of Labor, or pursuant thereto. The Contractor/Seller shall permit

access to its books, records, and accounts by the Secretary of Labor for purposes of investigation to ascertain compliance with such rules, regulations, and orders.

(h) In the event of a that the Contractor/Seller is in noncompliance with the nondiscrimination clauses of this contract or with any of such rules, regulations, or orders, this contract may be canceled, terminated or suspended in whole or in part and the contractor/seller may be declared ineligible for further Government contracts in accordance with procedures authorized in Executive Order 11246 of September 24, 1965, and such other sanctions may be imposed and remedies invoked as provided in Executive Order 11246 of September 24, 1965, or by rule, regulation, or order of the Secretary of Labor, or as otherwise provided by law.

(i) The contractor/seller will include the provisions of paragraphs (a) through (h) in every subcontract or purchase order unless exempted by rules, regulations, or orders of the Secretary of Labor issued pursuant to section 204 of Executive Order 11246 of September 24, 1965, so that such provisions will be binding upon each sub[contractor/seller] or vendor. The [contractor/seller] will take such action with respect to any subcontract or purchase order as may be directed by the Secretary of Labor as a means of enforcing such provisions including sanctions for noncompliance: Provided, however, that in the event the [contractor/seller] becomes involved in, or is threatened with, litigation with a subcontractor or vendor as a result of such direction, the [contractor/seller] may request the United States to enter into such litigation to protect the interests of the United States.

(j) Compliance with the requirements of this clause shall be to the maximum extent consistent with, but not in derogation of, compliance with section 7(b) of the Indian Self-Determination and Education Assistance Act and the Indian Preference clause of this contract.

#### **40. Employment, Training, and Contracting Opportunities for Low-Income Persons, Section 3 of the Housing and Urban Development Act of 1968.**

(a) The work to be performed under this contract is subject to the requirements of Section 3 of the Housing and Urban Development Act of 1968, as amended, 12 U.S.C. 1701u (section 3). The purpose of section 3 is to ensure that employment and other economic opportunities generated by HUD assistance or HUD-assisted projects covered by Section 3, shall, to the greatest extent feasible, be directed to low- and very low-income persons, particularly persons who are recipients of HUD assistance for housing.

(b) The parties to this contract agree to comply with HUD's regulations in 24 CFR Part 75, which implement Section 3. As evidenced by their execution of this contract, the parties to this contract certify that they are under no contractual or other impediment that would prevent them from complying with the Part 75 regulations.

(c) The contractor agrees to send to each labor organization or representative of workers with which the contractor has a collective bargaining agreement or other understanding, if any, a notice advising the labor organization or workers' representative of the contractor's commitments under this section 3 clause and will post copies of the notice in conspicuous places at the work site where both employees and applicants for training and employment positions can see the notice. The notice shall describe the Section 3 prioritization requirements and shall state the minimum percentages of labor hour requirements established in the Benchmark Notice (FR-6085-N-04).

(d) The contractor agrees to include this section 3 clause in every subcontract subject to compliance with regulations in 24 CFR Part 75, and agrees to take appropriate action, as provided in an applicable provision of the subcontract or in this section 3 clause, upon a finding that the subcontractor is in violation of the regulations in 24 CFR Part 75. The contractor will not subcontract with any subcontractor where the contractor has notice or knowledge that the subcontractor has been found in violation of the regulations in 24 CFR Part 75.

(e) Noncompliance with HUD's regulations in 24 CFR Part 75 may result in sanctions, termination of this contract for default, and debarment or suspension from future HUD assisted contracts.

(f) Contracts, subcontracts, grants, or subgrants subject to Section 7(b) of the Indian Self-Determination and Education Assistance Act (25 U.S.C. 5307(b)) or subject to tribal preference requirements as authorized under 101(k) of the Native American Housing Assistance and Self-Determination Act (25 U.S.C. 4111(k)) must provide preferences in employment, training, and business opportunities to Indians and Indian organizations, and are therefore not subject to the requirements of 24 CFR Part 75.

---

#### 41. Interest of Members of Congress

No member of or delegate to the Congress of the United States of America shall be admitted to any share or part of this contract or to any benefit that may arise therefrom.

#### 42. Interest of Members, Officers, or Employees and Former Members, Officers, or Employees

No member, officer, or employee of the PHA, no member of the governing body of the locality in which the project is situated, no member of the governing body of the locality in which the PHA was activated, and no other public official of such locality or localities who exercises any functions or responsibilities with respect to the project, shall, during his or her tenure, or for one year thereafter, have any interest, direct or indirect, in this contract or the proceeds thereof.

#### 43. Limitations on Payments made to Influence Certain Federal Financial Transactions

- (a) The Contractor agrees to comply with Section 1352 of Title 31, United States Code which prohibits the use of **Acts** Federal appropriated funds to pay any person for influencing or attempting to influence an officer or employee of any agency, a Member of Congress, and officer or employee of Congress, or an employee of a Member of Congress in connection with any of the following covered Federal actions: the awarding of any Federal contract; the making of any Federal grant; the making of any Federal loan; the entering into of any cooperative agreement; or the modification of any Federal contract, grant, loan, or cooperative agreement.
- (b) The Contractor further agrees to comply with the requirement of the Act to furnish a disclosure (OMB Standard Form LLL, Disclosure of Lobbying Activities) if any funds other than Federal appropriated funds (including profit or fee received under a covered Federal transaction) have been paid, or will be paid, to any person for influencing or attempting to influence an officer or employee of any agency, a Member of Congress, an officer or employee of Congress, or an employee of a Member of Congress in connection with a Federal contract, grant, loan, or cooperative agreement.

#### 44. Royalties and Patents

The Contractor shall pay all royalties and license fees. It shall defend all suits or claims for infringement of any patent rights and shall save the PHA harmless from loss on account thereof; except that the PHA shall be responsible for all such loss when a particular design, process or the product of a particular manufacturer or manufacturers is specified and the Contractor has no reason to believe that the specified design, process, or product is an infringement. If, however, the Contractor has reason to believe that any design, process or product specified is an infringement of a patent, the Contractor shall promptly notify the Contracting Officer. Failure to give such notice shall make the Contractor responsible for resultant loss.

#### 45. Examination and Retention of Contractor's Records

- (a) The PHA, HUD, or Comptroller General of the United States, or any of their duly authorized representatives shall, until 3 years after final payment under this contract, have access to and the right to examine any of the Contractor's directly pertinent books, documents, papers, or other records involving transactions related to this contract for the purpose of making audit, examination, excerpts, and transcriptions.
- (b) The Contractor agrees to include in first-tier subcontracts under this contract a clause substantially the same as paragraph (a) above. "Subcontract," as used in this clause, excludes purchase orders not exceeding \$10,000.
- (c) The periods of access and examination in paragraphs (a) and (b) above for records relating to (1) appeals under the Disputes clause of this contract, (2) litigation or settlement of claims arising from the performance of this contract, or (3) costs and expenses of this contract to which the PHA, HUD, or Comptroller General or any of their duly authorized representatives has taken exception shall continue until disposition of such appeals, litigation, claims, or exceptions.

#### 46. Labor Standards - Davis-Bacon and Related

If the total amount of this contract exceeds \$2,000, the Federal labor standards set forth in the clause below shall apply to the development or construction work to be performed under the contract.

- (a) Minimum Wages.
  - (1) All laborers and mechanics employed under this contract in the development or construction of the project(s) involved will be paid unconditionally and not less often than once a week, and without subsequent deduction or rebate on any account (except such payroll deductions as are permitted by regulations issued by the Secretary of Labor under the Copeland Act (29 CFR Part 3)), the full amount of wages and bona fide fringe benefits (or cash equivalents thereof) due at time of payment computed at rates not less than those contained in the wage determination of the Secretary of Labor which is attached hereto and made a part hereof, regardless of any contractual relationship which may be alleged to exist between the Contractor and such laborers and mechanics. Contributions made or costs reasonably anticipated for bona fide fringe benefits under Section 1(b)(2) of the Davis-Bacon Act on behalf of laborers or mechanics are considered wages paid to such laborers or mechanics, subject to the provisions of 29 CFR 5.5(a)(1)(iv); also, regular contributions made or costs incurred for more than a weekly period (but not less often than quarterly) under plans, funds, or programs which cover the regular weekly period, are deemed to be constructively made or incurred during such weekly period. Such laborers and mechanics shall be paid the appropriate wage rate and fringe benefits in the wage determination for the classification of work actually performed, without regard to skill, except as provided in 29 CFR 5.5(a)(4). Laborers or mechanics performing work in more than one classification may be compensated at the rate specified for each classification for the time actually worked therein; provided, that the employer's payroll records accurately set forth the time spent in each classification in which work is performed. The wage determination (including any additional classification and wage rates conformed under 29 CFR 5.5(a)(1)(ii) and the Davis-Bacon poster (WH-1321) shall

be posted at all times by the Contractor and its subcontractors at the site of the work in a prominent and accessible place where it can be easily seen by the workers.

(2) (i) Any class of laborers or mechanics, including

helpers, which is not listed in the wage determination and which is to be employed under the contract shall be classified in conformance with the wage determination. HUD shall approve an additional classification and wage rate and fringe benefits therefor only when all the following criteria have been met: (A) The work to be performed by the classification requested is not performed by a classification in the wage determination; and (B) The classification is utilized in the area by the construction industry; and (C) The proposed wage rate, including any bona fide fringe benefits, bears a reasonable relationship to the wage rates contained in the wage determination.

- (ii) If the Contractor and the laborers and mechanics to be employed in the classification (if known), or their representatives, and HUD or its designee agree on the classification and wage rate (including the amount designated for fringe benefits where appropriate), a report of the action taken shall be sent by HUD or its designee to the Administrator of the Wage and Hour Division, Employee Standards Administration, U.S. Department of Labor, Washington, DC 20210. The Administrator, or an authorized representative, will approve, modify, or disapprove every additional classification action within 30 days of receipt and so advise HUD or its designee or will notify HUD or its designee within the 30-day period that additional time is necessary.
- (iii) In the event the Contractor, the laborers or mechanics to be employed in the classification or their representatives, and HUD or its designee do not agree on the proposed classification and wage rate (including the amount designated for fringe benefits, where appropriate), HUD or its designee shall refer the questions, including the views of all interested parties and the recommendation of HUD or its designee, to the Administrator of the Wage and Hour Division for determination. The Administrator, or an authorized representative, will issue a determination within 30 days of receipt and so advise HUD or its designee or will notify HUD or its designee within the 30-day period that additional time is necessary.
- (iv) The wage rate (including fringe benefits where appropriate) determined pursuant to subparagraphs (a)(2)(ii) or (iii) of this clause shall be paid to all workers performing work in the classification under this contract from the first day on which work is performed in classification.
- (3) Whenever the minimum wage rate prescribed in the contract for a class of laborers or mechanics includes a fringe benefit which is not expressed as an hourly rate, the Contractor shall either pay the benefit as stated in the wage determination or shall pay another bona fide fringe benefit or an hourly cash equivalent thereof.
- (4) If the Contractor does not make payments to a trustee or other third person, the Contractor may consider as part of the wages of any laborer or mechanic the

amount of any costs reasonably anticipated in providing bona fide fringe benefits under a plan or program; provided, that the Secretary of Labor has found, upon the written request of the Contractor, that the applicable standards of the Davis-Bacon Act have been met. The Secretary of Labor may require the Contractor to set aside in a separate account assets for the meeting of obligations under the plan or program.

- (b) Withholding of funds. HUD or its designee shall, upon its own action or upon written request of an authorized representative of the Department of Labor, withhold or cause to be withheld from the Contractor under this contract or any other Federal contract with the same prime Contractor, or any other Federally-assisted contract subject to Davis-Bacon prevailing wage requirements, which is held by the same prime Contractor, so much of the accrued payments or advances as may be considered necessary to pay laborers and mechanics, including apprentices, trainees, and helpers, employed by the Contractor or any subcontractor the full amount of wages required by the contract. In the event of failure to pay any laborer or mechanic, including any apprentice, trainee, or helper, employed or working in the construction or development of the project, all or part of the wages required by the contract, HUD or its designee may, after written notice to the Contractor, take such action as may be necessary to cause the suspension of any further payment, advance, or guarantee of funds until such violations have ceased. HUD or its designee may, after written notice to the Contractor, disburse such amounts withheld for and on account of the Contractor or subcontractor to the respective employees to whom they are due.
- (c) Payrolls and basic records.
- (1) Payrolls and basic records relating thereto shall be maintained by the Contractor during the course of the work and preserved for a period of three years thereafter for all laborers and mechanics working in the construction or development of the project. Such records shall contain the name, address, and social security number of each such worker, his or her correct classification, hourly rates of wages paid (including rates of contributions or costs anticipated for bona fide fringe benefits or cash equivalents thereof of the types described in section 1(b)(2)(B) of the Davis-Bacon Act), daily and weekly number of hours worked, deductions made, and actual wages paid. Whenever the Secretary of Labor has found, under 29 CFR 5.5(a)(1)(iv), that the wages of any laborer or mechanic include the amount of costs reasonably anticipated in providing benefits under a plan or program described in section 1(b)(2)(B) of the Davis-Bacon Act, the Contractor shall maintain records which show that the commitment to provide such benefits is enforceable, that the plan or program is financially responsible, and that the plan or program has been communicated in writing to the laborers or mechanics affected, and records which show the costs anticipated or the actual cost incurred in providing such benefits. Contractors employing apprentices or trainees under approved programs shall maintain written evidence of the registration of apprenticeship programs and certification of trainee programs, the registration of the apprentices and trainees, and the ratios and wage rates prescribed in the applicable programs.



(2) (i) The Contractor shall submit weekly for each week in which any contract work is performed a copy of all payrolls to the Contracting Officer for transmission to HUD or its designee. The payrolls submitted shall set out accurately and completely all of the information required to be maintained under subparagraph (c)(1) of this clause. This information may be submitted in any form desired. Optional Form WH-347 (Federal Stock Number 029-005-00014-1) is available for this purpose and may be purchased from the Superintendent of Documents, U.S. Government Printing Office, Washington, D.C. 20402. The Contractor is responsible for the submission of copies of payrolls by all subcontractors. (Approved by the Office of Management and Budget under OMB Control Number 1214-0149.)

(ii) Each payroll submitted shall be accompanied by a "Statement of Compliance," signed by the Contractor or subcontractor or his or her agent who pays or supervises the payment of the persons employed under the contract and shall certify the following:

- (A) That the payroll for the payroll period contains the information required to be maintained under paragraph (c) (1) of this clause and that such information is correct and complete;
  - (B) That each laborer or mechanic (including each helper, apprentice, and trainee) employed on the contract during the payroll period has been paid the full weekly wages earned, without rebate, either directly or indirectly, and that no deductions have been made either directly or indirectly from the full wages earned, other than permissible deductions as set forth in 29 CFR Part 3; and
  - (C) That each laborer or mechanic has been paid not less than the applicable wage rates and fringe benefits or cash equivalents for the classification of work performed, as specified in the applicable wage determination incorporated into the contract.
- (iii) The weekly submission of a properly executed certification set forth on the reverse side of Optional Form WH-347 shall satisfy the requirements for submission of the "Statement of Compliance" required by subparagraph (c)(2)(ii) of this clause.
- (iv) The falsification of any of the above certifications may subject the Contractor or subcontractor to civil or criminal prosecution under Section 1001 of Title 18 and Section 3729 of Title 31 of the United States Code.

(3) The Contractor or subcontractor shall make the records required under subparagraph (c)(1) available for inspection, copying, or transcription by authorized representatives of HUD or its designee, the Contracting Officer, or the Department of Labor and shall permit such representatives to interview employees during working hours on the job. If the Contractor or subcontractor fails to submit the required records or to make them available, HUD or its designee may, after written notice to the Contractor, take such action as may be necessary to cause the suspension of any further payment, advance, or guarantee of funds. Furthermore, failure to submit the required records upon request or to

make such records available may be grounds for debarment action pursuant to 29 CFR 5.12.

- (d) (1) Apprentices. Apprentices will be permitted to work at less than the predetermined rate for the work they performed when they are employed pursuant to and individually registered in a bona fide apprenticeship program registered with the U.S. Department of Labor, Employment and Training Administration, Office of Apprenticeship and Training, Employer and Labor Services (OATELS), or with a State Apprenticeship Agency recognized by OATELS, or if a person is employed in his or her first 90 days of probationary employment as an apprentice in such an apprenticeship program, who is not individually registered in the program, but who has been certified by OATELS or a State Apprenticeship Agency (where appropriate) to be eligible for probationary employment as an apprentice. The allowable ratio of apprentices to journeymen on the job site in any craft classification shall not be greater than the ratio permitted to the Contractor as to the entire work force under the registered program. Any worker listed on a payroll at an apprentice wage rate, who is not registered or otherwise employed as stated in this paragraph, shall be paid not less than the applicable wage rate on the wage determination for the classification of work actually performed. In addition, any apprentice performing work on the job site in excess of the ratio permitted under the registered program shall be paid not less than the applicable wage rate on the wage determination for the work actually performed. Where a contractor is performing construction on a project in a locality other than that in which its program is registered, the ratios and wage rates (expressed in percentages of the journeyman's hourly rate) specified in the Contractor's or subcontractor's registered program shall be observed. Every apprentice must be paid at not less than the rate specified in the registered program for the apprentice's level of progress, expressed as a percentage of the journeyman hourly rate specified in the applicable wage determination. Apprentices shall be paid fringe benefits in accordance with the provisions of the apprenticeship program. If the apprenticeship program does not specify fringe benefits, apprentices must be paid the full amount of fringe benefits listed on the wage determination for the applicable classification. If the Administrator of the Wage and Hour Division determines that a different practice prevails for the applicable apprentice classification, fringes shall be paid in accordance with that determination. In the event OATELS, or a State Apprenticeship Agency recognized by OATELS, withdraws approval of an apprenticeship program, the Contractor will no longer be permitted to utilize apprentices at less than the applicable predetermined rate for the work performed until an acceptable program is approved.
- (2) Trainees. Except as provided in 29 CFR 5.16, trainees will not be permitted to work at less than the predetermined rate for the work performed unless they are employed pursuant to and individually registered in a program which has received prior approval, evidenced by formal certification by the U.S. Department of Labor, Employment and Training Administration. The ratio of trainees to journeymen on the job site shall not be greater than permitted under

the plan approved by the Employment and Training Administration. Every trainee must be paid at not less than the rate specified in the approved program for the trainee's level of progress, expressed as a percentage of the journeyman hourly rate specified in the applicable wage determination. Trainees shall be paid fringe benefits in accordance with the provisions of the trainee program. If the trainee program does not mention fringe benefits, trainees shall be paid the full amount of fringe benefits listed in the wage determination unless the Administrator of the Wage and Hour Division determines that there is an apprenticeship program associated with the corresponding journeyman wage rate in the wage determination which provides for less than full fringe benefits for apprentices. Any employee listed on the payroll at a trainee rate who is not registered and participating in a training plan approved by the Employment and Training Administration shall be paid not less than the applicable wage rate in the wage determination for the classification of work actually performed. In addition, any trainee performing work on the job site in excess of the ratio permitted under the registered program shall be paid not less than the applicable wage rate in the wage determination for the work actually performed. In the event the Employment and Training Administration withdraws approval of a training program, the Contractor will no longer be permitted to utilize trainees at less than the applicable predetermined rate for the work performed until an acceptable program is approved.

- (3) Equal employment opportunity. The utilization of apprentices, trainees, and journeymen under this clause shall be in conformity with the equal employment opportunity requirements of Executive Order 11246, as amended, and 29 CFR Part 30.
- (e) Compliance with Copeland Act requirements. The Contractor shall comply with the requirements of 29 CFR Part 3, which are hereby incorporated by reference in this contract.
- (f) Contract termination; debarment. A breach of this contract clause may be grounds for termination of the contract and for debarment as a Contractor and a subcontractor as provided in 29 CFR 5.12.
- (g) Compliance with Davis-Bacon and related Act requirements. All rulings and interpretations of the Davis-Bacon and related Acts contained in 29 CFR Parts 1, 3, and 5 are herein incorporated by reference in this contract.
- (h) Disputes concerning labor standards. Disputes arising out of the labor standards provisions of this clause shall not be subject to the general disputes clause of this contract. Such disputes shall be resolved in accordance with the procedures of the Department of Labor set forth in 29 CFR Parts 5, 6, and 7. Disputes within the meaning of this clause include disputes between the Contractor (or any of its subcontractors) and the PHA, HUD, the U.S. Department of Labor, or the employees or their representatives.
- (i) Certification of eligibility.
  - (1) By entering into this contract, the Contractor certifies that neither it (nor he or she) nor any person or firm who has an interest in the Contractor's firm is a person or firm ineligible to be awarded contracts by the United States Government by virtue of section 3(a) of the Davis-Bacon Act or 29 CFR 5.12(a)(1).

- (2) No part of this contract shall be subcontracted to any person or firm ineligible for award of a United States Government contract by virtue of section 3(a) of the Davis-Bacon Act or 29 CFR 5.12(a)(1).
- (3) The penalty for making false statements is prescribed in the U. S. Criminal Code, 18 U.S.C. 1001.
- (j) Contract Work Hours and Safety Standards Act. As used in this paragraph, the terms "laborers" and "mechanics" include watchmen and guards.
  - (1) Overtime requirements. No contractor or subcontractor contracting for any part of the contract work which may require or involve the employment of laborers or mechanics, including watchmen and guards, shall require or permit any such laborer or mechanic in any workweek in which the individual is employed on such work to work in excess of 40 hours in such workweek unless such laborer or mechanic receives compensation at a rate not less than one and one-half times the basic rate of pay for all hours worked in excess of 40 hours in such workweek.
  - (2) Violation; liability for unpaid wages; liquidated damages. In the event of any violation of the provisions set forth in subparagraph (j)(1) of this clause, the Contractor and any subcontractor responsible therefor shall be liable for the unpaid wages. In addition, such Contractor and subcontractor shall be liable to the United States (in the case of work done under contract for the District of Columbia or a territory, to such District or to such territory), for liquidated damages. Such liquidated damages shall be computed with respect to each individual laborer or mechanic (including watchmen and guards) employed in violation of the provisions set forth in subparagraph (j)(1) of this clause, in the sum of \$27 for each calendar day on which such individual was required or permitted to work in excess of the standard workweek of 40 hours without payment of the overtime wages required by provisions set forth in subparagraph (j)(1) of this clause. DOL posts current fines at: <https://www.dol.gov/whd/govcontracts/cwhssa.htm#cmp>
  - (3) Withholding for unpaid wages and liquidated damages. HUD or its designee shall upon its own action or upon written request of an authorized representative of the Department of Labor withhold or cause to be withheld, from any moneys payable on account of work performed by the Contractor or subcontractor under any such contract or any Federal contract with the same prime Contractor, or any other Federally-assisted contract subject to the Contract Work Hours and Safety Standards Act, which is held by the same prime Contractor, such sums as may be determined to be necessary to satisfy any liabilities of such Contractor or subcontractor for unpaid wages and liquidated damages as provided in the provisions set forth in subparagraph (j)(2) of this clause.
- (k) Subcontracts. The Contractor or subcontractor shall insert in any subcontracts all the provisions contained in this clause, and such other clauses as HUD or its designee may by appropriate instructions require, and also a clause requiring the subcontractors to include these provisions in any lower tier subcontracts. The prime Contractor shall be responsible for the compliance by any subcontractor or lower tier subcontractor with all these provisions.

---

47. Non-Federal Prevailing Wage Rates

(a) Any prevailing wage rate (including basic hourly rate and any fringe benefits), determined under State or tribal law to be prevailing, with respect to any employee in any trade or position employed under the contract, is inapplicable to the contract and shall not be enforced against the Contractor or any subcontractor, with respect to employees engaged under the contract whenever such non-Federal prevailing wage rate exceeds:

(1) The applicable wage rate determined by the Secretary of Labor pursuant to the Davis-Bacon Act (40 U.S.C. 3141 et seq.) to be prevailing in the locality with respect to such trade;

(b) An applicable apprentice wage rate based thereon specified in an apprenticeship program registered with the U.S. Department of Labor (DOL) or a DOL-recognized State Apprenticeship Agency; or

(c) An applicable trainee wage rate based thereon specified in a DOL-certified trainee program.

48. Procurement of Recovered Materials.

(a) In accordance with Section 6002 of the Solid Waste Disposal Act, as amended by the Resource Conservation and Recovery Act, the Contractor shall procure items designated in guidelines of the Environmental Protection Agency (EPA) at 40 CFR Part 247 that contain the highest percentage of recovered materials practicable, consistent with maintaining a satisfactory level of competition. The Contractor shall procure items designated in the EPA guidelines that contain the highest percentage of recovered materials practicable unless the Contractor determines that such items: (1) are not reasonably available in a reasonable period of time; (2) fail to meet reasonable performance standards, which shall be determined on the basis of the guidelines of the National Institute of Standards and Technology, if applicable to the item; or (3) are only available at an unreasonable price.

( ) Paragraph (a) of this clause shall apply to items purchased under this contract where: (1) the Contractor purchases in excess of \$10,000 of the item under this contract; or (2) during the preceding Federal fiscal year, the Contractor: (i) purchased any amount of the items for use under a contract that was funded with Federal appropriations and was with a Federal agency or a State agency or agency of a political subdivision of a State; and (ii) purchased a total of in excess of \$10,000 of the item both under and outside that contract.

# Attachment H Acknowledgment of Addenda





ACKNOWLEDGEMENT OF  
ADDENDA (ATTACHMENT H)

Respondent has received the following Addenda, receipt of which is hereby acknowledged:

Addendum Number: \_\_\_\_\_ Date Received: \_\_\_\_\_

Addendum Number: \_\_\_\_\_ Date Received: \_\_\_\_\_

Addendum Number: \_\_\_\_\_ Date Received: \_\_\_\_\_

Addendum Number: \_\_\_\_\_ Date Received: \_\_\_\_\_

\_\_\_\_\_  
(Company Name)

\_\_\_\_\_  
(Signature)

\_\_\_\_\_  
(Printed or Typed Name)

**Attachment I**  
**LOUISIANA UNIFORM**  
**PUBLIC WORK BID**  
**FORM**  
**(Entry of Proposed Fees)**



# LOUISIANA UNIFORM PUBLIC WORK BID FORM

**TO:** The Housing Authority of New Orleans  
4100 Touro Street  
New Orleans, LA 70122  
\_\_\_\_\_  
*(Owner to provide name and address of owner)*

**BID FOR:** DOJ Repairs and Upgrades at Guste III  
Housing Community – Interior and Exterior  
\_\_\_\_\_  
\_\_\_\_\_  
*(Owner to provide name of project and other identifying information)*

The undersigned bidder hereby declares and represents that she/he: a) has carefully examined and understands the Bidding Documents, b) has not received, relied on, or based his bid on any verbal instructions contrary to the Bidding Documents or any addenda, c) has personally inspected and is familiar with the project site, and hereby proposes to provide all labor, materials, tools, appliances and facilities as required to perform, in a workmanlike manner, all work and services for the construction and completion of the referenced project, all in strict accordance with the Bidding Documents prepared by: \_\_\_\_\_ and dated: \_\_\_\_\_  
*(Owner to provide name of entity preparing bidding documents.)*

Bidders must acknowledge all addenda. The Bidder acknowledges receipt of the following **ADDENDA:** (Enter the number the Designer has assigned to each of the addenda that the Bidder is acknowledging) \_\_\_\_\_ .

**TOTAL BASE BID:** For all work required by the Bidding Documents (including any and all unit prices designated “Base Bid” \* but not alternates) the sum of:  
\_\_\_\_\_ Dollars (\$ \_\_\_\_\_)

**ALTERNATES:** For any and all work required by the Bidding Documents for Alternates including any and all unit prices designated as alternates in the unit price description.

**Alternate No. 1** *(Owner to provide description of alternate and state whether add or deduct)* for the lump sum of:  
N/A Dollars (\$ \_\_\_\_\_)

**Alternate No. 2** *(Owner to provide description of alternate and state whether add or deduct)* for the lump sum of:  
N/A Dollars (\$ \_\_\_\_\_)

**Alternate No. 3** *(Owner to provide description of alternate and state whether add or deduct)* for the lump sum of:  
N/A Dollars (\$ \_\_\_\_\_)

**NAME OF BIDDER:** \_\_\_\_\_

**ADDRESS OF BIDDER:** \_\_\_\_\_

**LOUISIANA CONTRACTOR’S LICENSE NUMBER:** \_\_\_\_\_

**NAME OF AUTHORIZED SIGNATORY OF BIDDER:** \_\_\_\_\_

**TITLE OF AUTHORIZED SIGNATORY OF BIDDER:** \_\_\_\_\_

**SIGNATURE OF AUTHORIZED SIGNATORY OF BIDDER \*\*:** \_\_\_\_\_

**DATE:** \_\_\_\_\_

## **THE FOLLOWING ITEMS ARE TO BE INCLUDED WITH THE SUBMISSION OF THIS LOUISIANA UNIFORM PUBLIC WORK BID FORM:**

\* The Unit Price Form shall be used if the contract includes unit prices. Otherwise it is not required and need not be included with the form. The number of unit prices that may be included is not limited and additional sheets may be included if needed.

\*\* **A CORPORATE RESOLUTION OR WRITTEN EVIDENCE** of the authority of the person signing the bid for the public work as prescribed by LA R.S. 38:2212(B)(5).

**BID SECURITY** in the form of a bid bond, certified check or cashier’s check as prescribed by LA R.S. 38:2218(A) attached to and made a part of this bid.

# Attachment J Certification of Contractor Non- Exclusion





**CERTIFICATION OF CONTRACTOR NON-EXCLUSION**

This certification applies to a sole proprietor or any bidding entity or any individual partner, incorporator, director, manager, officer, organizer, or member, who has at least 10% ownership in the bidding entity, for consideration for award of contracts, in accordance with LA R.S. 38:2227.

A conviction of or plea of guilty or no contest to the following state crimes or equivalent federal crimes shall permanently bar any person or the bidding entity from bidding on public projects:

- (a) Public bribery
- (b) Corrupt Influencing
- (c) Extortion
- (d) Money laundering

A conviction of or plea of guilty or no contest to the following state crimes or equivalent federal crimes shall bar any person or the bidding entity from bidding on public projects for a period of five years from the date of conviction or from the date of the entrance of the plea of guilty or no contest:

- (a) Theft
- (b) Identity theft
- (c) Theft of a business record
- (d) False accounting
- (e) Issuing worthless checks
- (f) Bank fraud
- (g) Forgery
- (h) Contractors; misapplication of payments
- (i) Malfeasance in office

The five-year prohibition shall apply only if the crime was committed during the solicitation or execution of a contract or bid awarded pursuant to the provisions of LA R.S. Title 38, Chapter 10 – Public Contracts.

Should information be discovered about a bidding entity that would be cause for debarment, suspension, exclusion, or determination of ineligibility for award of a contract, HANO shall report and submit supporting documentation to the applicable regulatory agency.

I hereby attest that I have not been convicted of, or have not entered a plea of guilty or nolo contendere to any of the crimes listed above or equivalent crimes.

\_\_\_\_\_  
(Print)

\_\_\_\_\_  
(Date)

\_\_\_\_\_  
(Signature)

# Attachment K E-Verification Affidavit

(Only Required Post-Bid by Awarded  
Bidder)



E-VERIFICATION AFFIDAVIT

(Employer)

STATE OF \_\_\_\_\_

CITY/COUNTY OF \_\_\_\_\_

I, \_\_\_\_\_ Being duly sworn, attests and says that:  
(Authorized Signatory)

\_\_\_\_\_ a private organization,  
(Name of Private Company/Employer)

duly registered in the aforementioned state, and contracted to perform work within the State of Louisiana, herein attests that I/we (the employer) are in compliance with the United States Department of Homeland Security's "E-Verify" program, which is mandated pursuant to La RS 38:2212.10. I further attest that I/we are registered in a status verification system to verify that all new employees in my/our (the employer) employ are legal citizens of the United States, or are legal aliens. Further, I/we shall continue to utilize a status verification system to confirm the legal status of all new employees assigned to this project during the term of this contract. In further compliance with the Immigration Reform and Immigrant Responsibility Act of 1996 administrated by the U.S. Department of Homeland Security, I/we shall require all subcontractors to submit to me/us (the employer) a sworn affidavit verifying its compliance with the Immigration Reform and Immigrant Responsibility Act of 1996, 8 U.S.C. 1324(a).

Signature of

\_\_\_\_\_  
(Authorized Signatory)

\_\_\_\_\_  
(Printed Name/Title of Authorized Signatory)

Sworn to and Subscribed before me:

This \_\_\_\_\_ day of \_\_\_\_\_, 20\_\_\_\_\_.

\_\_\_\_\_  
Notary Public

My Commission Expires \_\_\_\_\_

(Must be Notarized to be valid)

# Attachment L

# Vendor Registration

# Form







**VENDOR SETUP FORM**

Company Name: \_\_\_\_\_

Physical Address: \_\_\_\_\_

City: \_\_\_\_\_ State: \_\_\_\_\_ Zip: \_\_\_\_\_

Owner/President: \_\_\_\_\_

Remit To Address: \_\_\_\_\_

City: \_\_\_\_\_ State: \_\_\_\_\_ Zip: \_\_\_\_\_

Contact Name: \_\_\_\_\_ Authorized Signature: \_\_\_\_\_

Contact Number: \_\_\_\_\_ Contact Fax: \_\_\_\_\_

Contact Email: \_\_\_\_\_ Company Website: \_\_\_\_\_

**Banking Information (Required for EFT Payment, if applicable):**

Bank Name: \_\_\_\_\_ Name on Bank Account: \_\_\_\_\_

Routing Number:

Account Number:

Type of Account:  Checking  Savings  Corporate/Commercial

Required: Taxpayer Identification Number: \_\_\_\_\_

**Type of Operation (Check all that apply):**

- Individual  Corporation  Manufacturer  Partnership  Distributor
- Sole Proprietorship  Retail Dealer  Agent/Broker  Limited Liability

**PLEASE ATTACH ANY REVISED INFORMATION INCLUDING W9 AND/OR BANKING UPDATED INFORMATION, AS REQUIRED.....**

Requisition #: \_\_\_\_\_ or N/A \_\_\_\_\_ (Direct pay items do not require a requisition #)

**Approvals:**

Requestor/Department: \_\_\_\_\_ Date: \_\_\_\_\_

Finance Approval: \_\_\_\_\_ Date: \_\_\_\_\_ 1099? Y N

Procurement Approval: \_\_\_\_\_ Date: \_\_\_\_\_

Date Entered: \_\_\_\_\_ Entered By: \_\_\_\_\_

\* Attach Documentation (If Provided)

## Select All Applicable Products/Service in Each Category:

### Voice Services & Products:

- Call Accounting
- Calling Cards
- Local Services
- Voice Bridging
- VoIP Solutions
- Call Center
- Telephone Equipment
- Long Distance Services
- Voice Systems
- Wireless/Cellular
- Other: \_\_\_\_\_
- Other: \_\_\_\_\_

### Network/Internet Services & Products:

- Converged Network Provider
- Internet Access
- Virtual Learning
- Custom Network/Internet Solutions
- Network Equipment
- Wireless LAN/MAN/WAN
- Other: \_\_\_\_\_
- Other: \_\_\_\_\_

### Video Services & Products:

- Audio/Visual Equipment
- Interactive Video & Multimedia Equipment
- Video Bridging
- Integration Services
- Network Access
- Other: \_\_\_\_\_
- Other: \_\_\_\_\_

### e-Learning Solutions:

- Course/Learning Management Application
- Training/Certification
- Course Content Provider
- Hosting – ASP Services
- Other: \_\_\_\_\_
- Other: \_\_\_\_\_

### Computer Services & Products:

- Application Software (Microsoft, Adobe, Lotus, etc.)
- E-mail Applications
- Network Devices
- SAN, Enterprise, Etc.
- Web & Application Hosting/IT Services
- Computers, Servers & Add-On Components
- Internet Content Filtering Applications & Devices
- Peripheral Equipment
- Storage Systems
- Other: \_\_\_\_\_
- Other: \_\_\_\_\_

### Additional Services & Products:

- Auditors
- Electrical Generators & Power Suppression Equip
- Office Furniture
- Consulting
- Library Supplies, Equipment & Furniture
- Office Supplies & Equipment
- Other: \_\_\_\_\_
- Other: \_\_\_\_\_
- Other: \_\_\_\_\_

Circle all that Apply: (DBE) (WBE) (MBE) (Section 3) (Small Business)

Required: (Attach a copy of your certification for all items circled above)

Check one: \_\_\_ African American \_\_\_ Hispanic \_\_\_ Native American \_\_\_ Asian \_\_\_ Caucasian \_\_\_ Other

## **Definitions:**

**Disadvantage Business Enterprise (DBE)** – A business enterprise that is 51% or more owned, controlled, and actively operated by one or more persons who are classified as members of a racial minority group, such as African American, Hispanic American, Asian Pacific American, Asian Indian American, Native American, Aleuts or Hasidic Jewish Americans.

**Woman Business Enterprise (WBE)** - A business enterprise that is 51% or more owned, controlled, and actively operated by one or more women.

**Section 3 Business** - A business that meets one of the following:

1. 51% or more owned and controlled by a resident of any HANO Housing site or whose full-time permanent workforce includes 30% of HANO residents of any housing site;
2. Hud Youthbuild Program in Orleans Parish;
3. Business concerns that are 51% or more owned and controlled by HANO residents or are low or very low-income Orleans Parish Residents or whose full-time permanent workforce includes 30% of HANO residents or low/very low-income Orleans Parish residents;
4. Business that subcontracts in excess of 25% of the total amount of subcontracts to business concerns identified in the preferences above.

**Small Business Enterprise (SBE)** — A business concern, including its affiliates, that is independently owned and operated and is not dominant in the field of operation for which it is bidding and qualifies as a small business under the criteria and size standards in 13 CFR Part 121 (see FAR 19.102).

## DECLARATION BY VENDOR

**I confirm that:**

- i) Neither I nor any employee of \_\_\_\_\_ is in any way connected to the Housing Authority of New Orleans or its employees or an immediate family member of any Housing Authority of New Orleans employee.
- ii) For each relationship, I will include a brief statement describing the relationship.
- iii) The information furnished is correct to the best of my knowledge and belief.

---

Printed Name of Authorized Signatory

---

Signature



## Request for Taxpayer Identification Number and Certification

**Give Form to the  
 requester. Do not  
 send to the IRS.**

▶ Go to [www.irs.gov/FormW9](http://www.irs.gov/FormW9) for instructions and the latest information.

Print or type. See Specific Instructions on page 3.	<p><b>1</b> Name (as shown on your income tax return). Name is required on this line; do not leave this line blank.</p> <hr/> <p><b>2</b> Business name/disregarded entity name, if different from above</p> <hr/> <p><b>3</b> Check appropriate box for federal tax classification of the person whose name is entered on line 1. Check only one of the following seven boxes.</p> <p> <input type="checkbox"/> Individual/sole proprietor or single-member LLC                 <input type="checkbox"/> C Corporation                 <input type="checkbox"/> S Corporation                 <input type="checkbox"/> Partnership                 <input type="checkbox"/> Trust/estate  <input type="checkbox"/> Limited liability company. Enter the tax classification (C=C corporation, S=S corporation, P=Partnership) ▶ _____  <small>Note: Check the appropriate box in the line above for the tax classification of the single-member owner. Do not check LLC if the LLC is classified as a single-member LLC that is disregarded from the owner unless the owner of the LLC is another LLC that is not disregarded from the owner for U.S. federal tax purposes. Otherwise, a single-member LLC that is disregarded from the owner should check the appropriate box for the tax classification of its owner.</small>  <input type="checkbox"/> Other (see instructions) ▶ _____         </p>	<p><b>4</b> Exemptions (codes apply only to certain entities, not individuals; see instructions on page 3):</p> <p>Exempt payee code (if any) _____</p> <p>Exemption from FATCA reporting code (if any) _____</p> <p><small>(Applies to accounts maintained outside the U.S.)</small></p>
	<p><b>5</b> Address (number, street, and apt. or suite no.) See instructions.</p> <hr/> <p><b>6</b> City, state, and ZIP code</p> <hr/> <p><b>7</b> List account number(s) here (optional)</p>	<p>Requester's name and address (optional)</p> <hr/>

### Part I Taxpayer Identification Number (TIN)

Enter your TIN in the appropriate box. The TIN provided must match the name given on line 1 to avoid backup withholding. For individuals, this is generally your social security number (SSN). However, for a resident alien, sole proprietor, or disregarded entity, see the instructions for Part I, later. For other entities, it is your employer identification number (EIN). If you do not have a number, see *How to get a TIN*, later.

**Note:** If the account is in more than one name, see the instructions for line 1. Also see *What Name and Number To Give the Requester* for guidelines on whose number to enter.

<b>Social security number</b>								
<table style="width: 100%; border-collapse: collapse;"> <tr> <td style="width: 25%; border: 1px solid black; height: 20px;"></td> <td style="width: 25%; border: 1px solid black; height: 20px;"></td> <td style="width: 25%; border: 1px solid black; height: 20px;"></td> <td style="width: 25%; border: 1px solid black; height: 20px;"></td> </tr> <tr> <td style="text-align: center;">-</td> <td style="text-align: center;">-</td> <td></td> <td></td> </tr> </table>					-	-		
-	-							
or								
<b>Employer identification number</b>								
<table style="width: 100%; border-collapse: collapse;"> <tr> <td style="width: 25%; border: 1px solid black; height: 20px;"></td> <td style="width: 25%; border: 1px solid black; height: 20px;"></td> <td style="width: 25%; border: 1px solid black; height: 20px;"></td> <td style="width: 25%; border: 1px solid black; height: 20px;"></td> </tr> <tr> <td style="text-align: center;">-</td> <td style="text-align: center;">-</td> <td></td> <td></td> </tr> </table>					-	-		
-	-							

### Part II Certification

Under penalties of perjury, I certify that:

1. The number shown on this form is my correct taxpayer identification number (or I am waiting for a number to be issued to me); and
2. I am not subject to backup withholding because: (a) I am exempt from backup withholding, or (b) I have not been notified by the Internal Revenue Service (IRS) that I am subject to backup withholding as a result of a failure to report all interest or dividends, or (c) the IRS has notified me that I am no longer subject to backup withholding; and
3. I am a U.S. citizen or other U.S. person (defined below); and
4. The FATCA code(s) entered on this form (if any) indicating that I am exempt from FATCA reporting is correct.

**Certification instructions.** You must cross out item 2 above if you have been notified by the IRS that you are currently subject to backup withholding because you have failed to report all interest and dividends on your tax return. For real estate transactions, item 2 does not apply. For mortgage interest paid, acquisition or abandonment of secured property, cancellation of debt, contributions to an individual retirement arrangement (IRA), and generally, payments other than interest and dividends, you are not required to sign the certification, but you must provide your correct TIN. See the instructions for Part II, later.

<b>Sign Here</b>	Signature of U.S. person ▶	Date ▶
------------------	----------------------------	--------

## General Instructions

Section references are to the Internal Revenue Code unless otherwise noted.

**Future developments.** For the latest information about developments related to Form W-9 and its instructions, such as legislation enacted after they were published, go to [www.irs.gov/FormW9](http://www.irs.gov/FormW9).

### Purpose of Form

An individual or entity (Form W-9 requester) who is required to file an information return with the IRS must obtain your correct taxpayer identification number (TIN) which may be your social security number (SSN), individual taxpayer identification number (ITIN), adoption taxpayer identification number (ATIN), or employer identification number (EIN), to report on an information return the amount paid to you, or other amount reportable on an information return. Examples of information returns include, but are not limited to, the following.

- Form 1099-INT (interest earned or paid)

- Form 1099-DIV (dividends, including those from stocks or mutual funds)
- Form 1099-MISC (various types of income, prizes, awards, or gross proceeds)
- Form 1099-B (stock or mutual fund sales and certain other transactions by brokers)
- Form 1099-S (proceeds from real estate transactions)
- Form 1099-K (merchant card and third party network transactions)
- Form 1098 (home mortgage interest), 1098-E (student loan interest), 1098-T (tuition)
- Form 1099-C (canceled debt)
- Form 1099-A (acquisition or abandonment of secured property)

Use Form W-9 only if you are a U.S. person (including a resident alien), to provide your correct TIN.

*If you do not return Form W-9 to the requester with a TIN, you might be subject to backup withholding. See What is backup withholding, later.*

By signing the filled-out form, you:

1. Certify that the TIN you are giving is correct (or you are waiting for a number to be issued),
2. Certify that you are not subject to backup withholding, or
3. Claim exemption from backup withholding if you are a U.S. exempt payee. If applicable, you are also certifying that as a U.S. person, your allocable share of any partnership income from a U.S. trade or business is not subject to the withholding tax on foreign partners' share of effectively connected income, and
4. Certify that FATCA code(s) entered on this form (if any) indicating that you are exempt from the FATCA reporting, is correct. See *What is FATCA reporting*, later, for further information.

**Note:** If you are a U.S. person and a requester gives you a form other than Form W-9 to request your TIN, you must use the requester's form if it is substantially similar to this Form W-9.

**Definition of a U.S. person.** For federal tax purposes, you are considered a U.S. person if you are:

- An individual who is a U.S. citizen or U.S. resident alien;
- A partnership, corporation, company, or association created or organized in the United States or under the laws of the United States;
- An estate (other than a foreign estate); or
- A domestic trust (as defined in Regulations section 301.7701-7).

**Special rules for partnerships.** Partnerships that conduct a trade or business in the United States are generally required to pay a withholding tax under section 1446 on any foreign partners' share of effectively connected taxable income from such business. Further, in certain cases where a Form W-9 has not been received, the rules under section 1446 require a partnership to presume that a partner is a foreign person, and pay the section 1446 withholding tax. Therefore, if you are a U.S. person that is a partner in a partnership conducting a trade or business in the United States, provide Form W-9 to the partnership to establish your U.S. status and avoid section 1446 withholding on your share of partnership income.

In the cases below, the following person must give Form W-9 to the partnership for purposes of establishing its U.S. status and avoiding withholding on its allocable share of net income from the partnership conducting a trade or business in the United States.

- In the case of a disregarded entity with a U.S. owner, the U.S. owner of the disregarded entity and not the entity;
- In the case of a grantor trust with a U.S. grantor or other U.S. owner, generally, the U.S. grantor or other U.S. owner of the grantor trust and not the trust; and
- In the case of a U.S. trust (other than a grantor trust), the U.S. trust (other than a grantor trust) and not the beneficiaries of the trust.

**Foreign person.** If you are a foreign person or the U.S. branch of a foreign bank that has elected to be treated as a U.S. person, do not use Form W-9. Instead, use the appropriate Form W-8 or Form 8233 (see Pub. 515, *Withholding of Tax on Nonresident Aliens and Foreign Entities*).

**Nonresident alien who becomes a resident alien.** Generally, only a nonresident alien individual may use the terms of a tax treaty to reduce or eliminate U.S. tax on certain types of income. However, most tax treaties contain a provision known as a "saving clause." Exceptions specified in the saving clause may permit an exemption from tax to continue for certain types of income even after the payee has otherwise become a U.S. resident alien for tax purposes.

If you are a U.S. resident alien who is relying on an exception contained in the saving clause of a tax treaty to claim an exemption from U.S. tax on certain types of income, you must attach a statement to Form W-9 that specifies the following five items.

1. The treaty country. Generally, this must be the same treaty under which you claimed exemption from tax as a nonresident alien.
2. The treaty article addressing the income.
3. The article number (or location) in the tax treaty that contains the saving clause and its exceptions.
4. The type and amount of income that qualifies for the exemption from tax.
5. Sufficient facts to justify the exemption from tax under the terms of the treaty article.

**Example.** Article 20 of the U.S.-China income tax treaty allows an exemption from tax for scholarship income received by a Chinese student temporarily present in the United States. Under U.S. law, this student will become a resident alien for tax purposes if his or her stay in the United States exceeds 5 calendar years. However, paragraph 2 of the first Protocol to the U.S.-China treaty (dated April 30, 1984) allows the provisions of Article 20 to continue to apply even after the Chinese student becomes a resident alien of the United States. A Chinese student who qualifies for this exception (under paragraph 2 of the first protocol) and is relying on this exception to claim an exemption from tax on his or her scholarship or fellowship income would attach to Form W-9 a statement that includes the information described above to support that exemption.

If you are a nonresident alien or a foreign entity, give the requester the appropriate completed Form W-8 or Form 8233.

## Backup Withholding

**What is backup withholding?** Persons making certain payments to you must under certain conditions withhold and pay to the IRS 24% of such payments. This is called "backup withholding." Payments that may be subject to backup withholding include interest, tax-exempt interest, dividends, broker and barter exchange transactions, rents, royalties, nonemployee pay, payments made in settlement of payment card and third party network transactions, and certain payments from fishing boat operators. Real estate transactions are not subject to backup withholding.

You will not be subject to backup withholding on payments you receive if you give the requester your correct TIN, make the proper certifications, and report all your taxable interest and dividends on your tax return.

**Payments you receive will be subject to backup withholding if:**

1. You do not furnish your TIN to the requester,
2. You do not certify your TIN when required (see the instructions for Part II for details),
3. The IRS tells the requester that you furnished an incorrect TIN,
4. The IRS tells you that you are subject to backup withholding because you did not report all your interest and dividends on your tax return (for reportable interest and dividends only), or
5. You do not certify to the requester that you are not subject to backup withholding under 4 above (for reportable interest and dividend accounts opened after 1983 only).

Certain payees and payments are exempt from backup withholding. See *Exempt payee code*, later, and the separate Instructions for the Requester of Form W-9 for more information.

Also see *Special rules for partnerships*, earlier.

## What is FATCA Reporting?

The Foreign Account Tax Compliance Act (FATCA) requires a participating foreign financial institution to report all United States account holders that are specified United States persons. Certain payees are exempt from FATCA reporting. See *Exemption from FATCA reporting code*, later, and the Instructions for the Requester of Form W-9 for more information.

## Updating Your Information

You must provide updated information to any person to whom you claimed to be an exempt payee if you are no longer an exempt payee and anticipate receiving reportable payments in the future from this person. For example, you may need to provide updated information if you are a C corporation that elects to be an S corporation, or if you no longer are tax exempt. In addition, you must furnish a new Form W-9 if the name or TIN changes for the account; for example, if the grantor of a grantor trust dies.

## Penalties

**Failure to furnish TIN.** If you fail to furnish your correct TIN to a requester, you are subject to a penalty of \$50 for each such failure unless your failure is due to reasonable cause and not to willful neglect.

**Civil penalty for false information with respect to withholding.** If you make a false statement with no reasonable basis that results in no backup withholding, you are subject to a \$500 penalty.

**Criminal penalty for falsifying information.** Willfully falsifying certifications or affirmations may subject you to criminal penalties including fines and/or imprisonment.

**Misuse of TINs.** If the requester discloses or uses TINs in violation of federal law, the requester may be subject to civil and criminal penalties.

## Specific Instructions

### Line 1

You must enter one of the following on this line; do not leave this line blank. The name should match the name on your tax return.

If this Form W-9 is for a joint account (other than an account maintained by a foreign financial institution (FFI)), list first, and then circle, the name of the person or entity whose number you entered in Part I of Form W-9. If you are providing Form W-9 to an FFI to document a joint account, each holder of the account that is a U.S. person must provide a Form W-9.

a. **Individual.** Generally, enter the name shown on your tax return. If you have changed your last name without informing the Social Security Administration (SSA) of the name change, enter your first name, the last name as shown on your social security card, and your new last name.

**Note: ITIN applicant:** Enter your individual name as it was entered on your Form W-7 application, line 1a. This should also be the same as the name you entered on the Form 1040/1040A/1040EZ you filed with your application.

b. **Sole proprietor or single-member LLC.** Enter your individual name as shown on your 1040/1040A/1040EZ on line 1. You may enter your business, trade, or "doing business as" (DBA) name on line 2.

c. **Partnership, LLC that is not a single-member LLC, C corporation, or S corporation.** Enter the entity's name as shown on the entity's tax return on line 1 and any business, trade, or DBA name on line 2.

d. **Other entities.** Enter your name as shown on required U.S. federal tax documents on line 1. This name should match the name shown on the charter or other legal document creating the entity. You may enter any business, trade, or DBA name on line 2.

e. **Disregarded entity.** For U.S. federal tax purposes, an entity that is disregarded as an entity separate from its owner is treated as a "disregarded entity." See Regulations section 301.7701-2(c)(2)(iii). Enter the owner's name on line 1. The name of the entity entered on line 1 should never be a disregarded entity. The name on line 1 should be the name shown on the income tax return on which the income should be reported. For example, if a foreign LLC that is treated as a disregarded entity for U.S. federal tax purposes has a single owner that is a U.S. person, the U.S. owner's name is required to be provided on line 1. If the direct owner of the entity is also a disregarded entity, enter the first owner that is not disregarded for federal tax purposes. Enter the disregarded entity's name on line 2, "Business name/disregarded entity name." If the owner of the disregarded entity is a foreign person, the owner must complete an appropriate Form W-8 instead of a Form W-9. This is the case even if the foreign person has a U.S. TIN.

### Line 2

If you have a business name, trade name, DBA name, or disregarded entity name, you may enter it on line 2.

### Line 3

Check the appropriate box on line 3 for the U.S. federal tax classification of the person whose name is entered on line 1. Check only one box on line 3.

IF the entity/person on line 1 is a(n) . . .	THEN check the box for . . .
• Corporation	Corporation
• Individual • Sole proprietorship, or • Single-member limited liability company (LLC) owned by an individual and disregarded for U.S. federal tax purposes.	Individual/sole proprietor or single-member LLC
• LLC treated as a partnership for U.S. federal tax purposes, • LLC that has filed Form 8832 or 2553 to be taxed as a corporation, or • LLC that is disregarded as an entity separate from its owner but the owner is another LLC that is not disregarded for U.S. federal tax purposes.	Limited liability company and enter the appropriate tax classification. (P= Partnership; C= C corporation; or S= S corporation)
• Partnership	Partnership
• Trust/estate	Trust/estate

### Line 4, Exemptions

If you are exempt from backup withholding and/or FATCA reporting, enter in the appropriate space on line 4 any code(s) that may apply to you.

#### Exempt payee code.

- Generally, individuals (including sole proprietors) are not exempt from backup withholding.
- Except as provided below, corporations are exempt from backup withholding for certain payments, including interest and dividends.
- Corporations are not exempt from backup withholding for payments made in settlement of payment card or third party network transactions.
- Corporations are not exempt from backup withholding with respect to attorneys' fees or gross proceeds paid to attorneys, and corporations that provide medical or health care services are not exempt with respect to payments reportable on Form 1099-MISC.

The following codes identify payees that are exempt from backup withholding. Enter the appropriate code in the space in line 4.

- 1—An organization exempt from tax under section 501(a), any IRA, or a custodial account under section 403(b)(7) if the account satisfies the requirements of section 401(f)(2)
- 2—The United States or any of its agencies or instrumentalities
- 3—A state, the District of Columbia, a U.S. commonwealth or possession, or any of their political subdivisions or instrumentalities
- 4—A foreign government or any of its political subdivisions, agencies, or instrumentalities
- 5—A corporation
- 6—A dealer in securities or commodities required to register in the United States, the District of Columbia, or a U.S. commonwealth or possession
- 7—A futures commission merchant registered with the Commodity Futures Trading Commission
- 8—A real estate investment trust
- 9—An entity registered at all times during the tax year under the Investment Company Act of 1940
- 10—A common trust fund operated by a bank under section 584(a)
- 11—A financial institution
- 12—A middleman known in the investment community as a nominee or custodian
- 13—A trust exempt from tax under section 664 or described in section 4947

The following chart shows types of payments that may be exempt from backup withholding. The chart applies to the exempt payees listed above, 1 through 13.

IF the payment is for . . .	THEN the payment is exempt for . . .
Interest and dividend payments	All exempt payees except for 7
Broker transactions	Exempt payees 1 through 4 and 6 through 11 and all C corporations. S corporations must not enter an exempt payee code because they are exempt only for sales of noncovered securities acquired prior to 2012.
Barter exchange transactions and patronage dividends	Exempt payees 1 through 4
Payments over \$600 required to be reported and direct sales over \$5,000 <sup>1</sup>	Generally, exempt payees 1 through 5 <sup>2</sup>
Payments made in settlement of payment card or third party network transactions	Exempt payees 1 through 4

<sup>1</sup> See Form 1099-MISC, Miscellaneous Income, and its instructions.

<sup>2</sup> However, the following payments made to a corporation and reportable on Form 1099-MISC are not exempt from backup withholding: medical and health care payments, attorneys' fees, gross proceeds paid to an attorney reportable under section 6045(f), and payments for services paid by a federal executive agency.

**Exemption from FATCA reporting code.** The following codes identify payees that are exempt from reporting under FATCA. These codes apply to persons submitting this form for accounts maintained outside of the United States by certain foreign financial institutions. Therefore, if you are only submitting this form for an account you hold in the United States, you may leave this field blank. Consult with the person requesting this form if you are uncertain if the financial institution is subject to these requirements. A requester may indicate that a code is not required by providing you with a Form W-9 with "Not Applicable" (or any similar indication) written or printed on the line for a FATCA exemption code.

A—An organization exempt from tax under section 501(a) or any individual retirement plan as defined in section 7701(a)(37)

B—The United States or any of its agencies or instrumentalities

C—A state, the District of Columbia, a U.S. commonwealth or possession, or any of their political subdivisions or instrumentalities

D—A corporation the stock of which is regularly traded on one or more established securities markets, as described in Regulations section 1.1472-1(c)(1)(i)

E—A corporation that is a member of the same expanded affiliated group as a corporation described in Regulations section 1.1472-1(c)(1)(ii)

F—A dealer in securities, commodities, or derivative financial instruments (including notional principal contracts, futures, forwards, and options) that is registered as such under the laws of the United States or any state

G—A real estate investment trust

H—A regulated investment company as defined in section 851 or an entity registered at all times during the tax year under the Investment Company Act of 1940

I—A common trust fund as defined in section 584(a)

J—A bank as defined in section 581

K—A broker

L—A trust exempt from tax under section 664 or described in section 4947(a)(1)

M—A tax exempt trust under a section 403(b) plan or section 457(g) plan

**Note:** You may wish to consult with the financial institution requesting this form to determine whether the FATCA code and/or exempt payee code should be completed.

### Line 5

Enter your address (number, street, and apartment or suite number). This is where the requester of this Form W-9 will mail your information returns. If this address differs from the one the requester already has on file, write NEW at the top. If a new address is provided, there is still a chance the old address will be used until the payor changes your address in their records.

### Line 6

Enter your city, state, and ZIP code.

## Part I. Taxpayer Identification Number (TIN)

**Enter your TIN in the appropriate box.** If you are a resident alien and you do not have and are not eligible to get an SSN, your TIN is your IRS individual taxpayer identification number (ITIN). Enter it in the social security number box. If you do not have an ITIN, see *How to get a TIN* below.

If you are a sole proprietor and you have an EIN, you may enter either your SSN or EIN.

If you are a single-member LLC that is disregarded as an entity separate from its owner, enter the owner's SSN (or EIN, if the owner has one). Do not enter the disregarded entity's EIN. If the LLC is classified as a corporation or partnership, enter the entity's EIN.

**Note:** See *What Name and Number To Give the Requester*, later, for further clarification of name and TIN combinations.

**How to get a TIN.** If you do not have a TIN, apply for one immediately. To apply for an SSN, get Form SS-5, Application for a Social Security Card, from your local SSA office or get this form online at [www.SSA.gov](http://www.SSA.gov). You may also get this form by calling 1-800-772-1213. Use Form W-7, Application for IRS Individual Taxpayer Identification Number, to apply for an ITIN, or Form SS-4, Application for Employer Identification Number, to apply for an EIN. You can apply for an EIN online by accessing the IRS website at [www.irs.gov/Businesses](http://www.irs.gov/Businesses) and clicking on Employer Identification Number (EIN) under Starting a Business. Go to [www.irs.gov/Forms](http://www.irs.gov/Forms) to view, download, or print Form W-7 and/or Form SS-4. Or, you can go to [www.irs.gov/OrderForms](http://www.irs.gov/OrderForms) to place an order and have Form W-7 and/or SS-4 mailed to you within 10 business days.

If you are asked to complete Form W-9 but do not have a TIN, apply for a TIN and write "Applied For" in the space for the TIN, sign and date the form, and give it to the requester. For interest and dividend payments, and certain payments made with respect to readily tradable instruments, generally you will have 60 days to get a TIN and give it to the requester before you are subject to backup withholding on payments. The 60-day rule does not apply to other types of payments. You will be subject to backup withholding on all such payments until you provide your TIN to the requester.

**Note:** Entering "Applied For" means that you have already applied for a TIN or that you intend to apply for one soon.

**Caution:** A disregarded U.S. entity that has a foreign owner must use the appropriate Form W-8.

## Part II. Certification

To establish to the withholding agent that you are a U.S. person, or resident alien, sign Form W-9. You may be requested to sign by the withholding agent even if item 1, 4, or 5 below indicates otherwise.

For a joint account, only the person whose TIN is shown in Part I should sign (when required). In the case of a disregarded entity, the person identified on line 1 must sign. Exempt payees, see *Exempt payee code*, earlier.

**Signature requirements.** Complete the certification as indicated in items 1 through 5 below.



**1. Interest, dividend, and barter exchange accounts opened before 1984 and broker accounts considered active during 1983.** You must give your correct TIN, but you do not have to sign the certification.

**2. Interest, dividend, broker, and barter exchange accounts opened after 1983 and broker accounts considered inactive during 1983.** You must sign the certification or backup withholding will apply. If you are subject to backup withholding and you are merely providing your correct TIN to the requester, you must cross out item 2 in the certification before signing the form.

**3. Real estate transactions.** You must sign the certification. You may cross out item 2 of the certification.

**4. Other payments.** You must give your correct TIN, but you do not have to sign the certification unless you have been notified that you have previously given an incorrect TIN. "Other payments" include payments made in the course of the requester's trade or business for rents, royalties, goods (other than bills for merchandise), medical and health care services (including payments to corporations), payments to a nonemployee for services, payments made in settlement of payment card and third party network transactions, payments to certain fishing boat crew members and fishermen, and gross proceeds paid to attorneys (including payments to corporations).

**5. Mortgage interest paid by you, acquisition or abandonment of secured property, cancellation of debt, qualified tuition program payments (under section 529), ABL E accounts (under section 529A), IRA, Coverdell ESA, Archer MSA or HSA contributions or distributions, and pension distributions.** You must give your correct TIN, but you do not have to sign the certification.

### What Name and Number to Give the Requester

For this type of account:	Give name and SSN of:
1. Individual	The individual
2. Two or more individuals (joint account) other than an account maintained by an FFI	The actual owner of the account or, if combined funds, the first individual on the account <sup>1</sup>
3. Two or more U.S. persons (joint account maintained by an FFI)	Each holder of the account
4. Custodial account of a minor (Uniform Gift to Minors Act)	The minor <sup>2</sup>
5. a. The usual revocable savings trust (grantor is also trustee) b. So-called trust account that is not a legal or valid trust under state law	The grantor-trustee <sup>1</sup> The actual owner <sup>1</sup>
6. Sole proprietorship or disregarded entity owned by an individual	The owner <sup>3</sup>
7. Grantor trust filing under Optional Form 1099 Filing Method 1 (see Regulations section 1.671-4(b)(2)(i)(A))	The grantor <sup>4</sup>

For this type of account:	Give name and EIN of:
8. Disregarded entity not owned by an individual	The owner
9. A valid trust, estate, or pension trust	Legal entity <sup>4</sup>
10. Corporation or LLC electing corporate status on Form 8832 or Form 2553	The corporation
11. Association, club, religious, charitable, educational, or other tax-exempt organization	The organization
12. Partnership or multi-member LLC	The partnership
13. A broker or registered nominee	The broker or nominee

For this type of account:	Give name and EIN of:
14. Account with the Department of Agriculture in the name of a public entity (such as a state or local government, school district, or prison) that receives agricultural program payments	The public entity
15. Grantor trust filing under the Form 1041 Filing Method or the Optional Form 1099 Filing Method 2 (see Regulations section 1.671-4(b)(2)(i)(B))	The trust

<sup>1</sup> List first and circle the name of the person whose number you furnish. If only one person on a joint account has an SSN, that person's number must be furnished.

<sup>2</sup> Circle the minor's name and furnish the minor's SSN.

<sup>3</sup> You must show your individual name and you may also enter your business or DBA name on the "Business name/disregarded entity" name line. You may use either your SSN or EIN (if you have one), but the IRS encourages you to use your SSN.

<sup>4</sup> List first and circle the name of the trust, estate, or pension trust. (Do not furnish the TIN of the personal representative or trustee unless the legal entity itself is not designated in the account title.) Also see *Special rules for partnerships*, earlier.

**\*Note:** The grantor also must provide a Form W-9 to trustee of trust.

**Note:** If no name is circled when more than one name is listed, the number will be considered to be that of the first name listed.

### Secure Your Tax Records From Identity Theft

Identity theft occurs when someone uses your personal information such as your name, SSN, or other identifying information, without your permission, to commit fraud or other crimes. An identity thief may use your SSN to get a job or may file a tax return using your SSN to receive a refund.

To reduce your risk:

- Protect your SSN,
  - Ensure your employer is protecting your SSN, and
  - Be careful when choosing a tax preparer.
- If your tax records are affected by identity theft and you receive a notice from the IRS, respond right away to the name and phone number printed on the IRS notice or letter.

If your tax records are not currently affected by identity theft but you think you are at risk due to a lost or stolen purse or wallet, questionable credit card activity or credit report, contact the IRS Identity Theft Hotline at 1-800-908-4490 or submit Form 14039.

For more information, see Pub. 5027, Identity Theft Information for Taxpayers.

Victims of identity theft who are experiencing economic harm or a systemic problem, or are seeking help in resolving tax problems that have not been resolved through normal channels, may be eligible for Taxpayer Advocate Service (TAS) assistance. You can reach TAS by calling the TAS toll-free case intake line at 1-877-777-4778 or TTY/TDD 1-800-829-4059.

**Protect yourself from suspicious emails or phishing schemes.** Phishing is the creation and use of email and websites designed to mimic legitimate business emails and websites. The most common act is sending an email to a user falsely claiming to be an established legitimate enterprise in an attempt to scam the user into surrendering private information that will be used for identity theft.

The IRS does not initiate contacts with taxpayers via emails. Also, the IRS does not request personal detailed information through email or ask taxpayers for the PIN numbers, passwords, or similar secret access information for their credit card, bank, or other financial accounts.

If you receive an unsolicited email claiming to be from the IRS, forward this message to [phishing@irs.gov](mailto:phishing@irs.gov). You may also report misuse of the IRS name, logo, or other IRS property to the Treasury Inspector General for Tax Administration (TIGTA) at 1-800-366-4484. You can forward suspicious emails to the Federal Trade Commission at [spam@uce.gov](mailto:spam@uce.gov) or report them at [www.ftc.gov/complaint](http://www.ftc.gov/complaint). You can contact the FTC at [www.ftc.gov/idtheft](http://www.ftc.gov/idtheft) or 877-IDTHEFT (877-438-4338). If you have been the victim of identity theft, see [www.IdentityTheft.gov](http://www.IdentityTheft.gov) and Pub. 5027.

Visit [www.irs.gov/IdentityTheft](http://www.irs.gov/IdentityTheft) to learn more about identity theft and how to reduce your risk.

## Privacy Act Notice

Section 6109 of the Internal Revenue Code requires you to provide your correct TIN to persons (including federal agencies) who are required to file information returns with the IRS to report interest, dividends, or certain other income paid to you; mortgage interest you paid; the acquisition or abandonment of secured property; the cancellation of debt; or contributions you made to an IRA, Archer MSA, or HSA. The person collecting this form uses the information on the form to file information returns with the IRS, reporting the above information. Routine uses of this information include giving it to the Department of Justice for civil and criminal litigation and to cities, states, the District of Columbia, and U.S. commonwealths and possessions for use in administering their laws. The information also may be disclosed to other countries under a treaty, to federal and state agencies to enforce civil and criminal laws, or to federal law enforcement and intelligence agencies to combat terrorism. You must provide your TIN whether or not you are required to file a tax return. Under section 3406, payers must generally withhold a percentage of taxable interest, dividend, and certain other payments to a payee who does not give a TIN to the payer. Certain penalties may also apply for providing false or fraudulent information.

# Attachment M

# Sample Bid Bond

# Form



SAMPLE FORM OF BID BOND

BID BOND

KNOW ALL MEN BY THESE PRESENTS:

That we, \_\_\_\_\_ as Principal, hereinafter called the Principal, and \_\_\_\_\_ a corporation duly organized under the laws of the State of Louisiana, as Surety, are held and firmly bound unto the Housing Authority of New Orleans (HANO), for the sum of \_\_\_\_\_ Dollars (\$ \_\_\_\_\_), for the payment of which sum well and truly to be made, the said Principal and the said Surety bind ourselves, our heirs, executors, administrators, successors, and assigns, jointly and severally, firmly be these presents.

**WHEREAS**, the Principal has submitted a bid for \_\_\_\_\_

\_\_\_\_\_ Located at \_\_\_\_\_  
(Identify project by number and brief description)

**NOW THEREFORE**, if the HANO shall accept the bid of the Principal and the Principal shall enter into a contract with the HANO in accordance with the terms of such bid, and give such bond or bonds as may be specified in the bidding or Contract Documents with good and sufficient surety for the faithful performance of such contract and for the prompt payment of labor and material furnished in the prosecution thereof, or in the event of the failure of the Principal to enter such Contract and give such bond or bonds, if the Principal shall pay to the HANO the difference not to exceed the penalty hereof between the amount specified in said bid and such larger amount for which the HANO may in good faith contract with another party to perform work covered by said bid or an appropriate required amount as specified in the Invitation for Bids, the foregoing to include any other purposes or items set out in, and to be subject to, provisions of La. R.S. 38:2241; 38:2216, as amended, then this obligation shall be null and void; otherwise to remain in full force and effect.

**IN WITNESS WHEREOF**, the Principal and Surety have hereto set their hands and seals, this \_\_ day of \_\_\_\_\_, 20\_\_\_\_\_.

**PRINCIPAL**

**SURETY**

\_\_\_\_\_  
(Name and Seal)

\_\_\_\_\_  
(Attorney-in-Fact)

**ATTEST:** \_\_\_\_\_

**ATTEST:** \_\_\_\_\_



# Attachment N Performance and Payment Bond Sample Form

(Only Required Post-Bid from  
Awarded Bidder)



**PERFORMANCE AND PAYMENT BOND (OR BONDS)**

CITY OF: \_\_\_\_\_ STATE OF: LOUISIANA

PARISH OF: \_\_\_\_\_ PROJECT NO: \_\_\_\_\_

**KNOW ALL MEN BY THESE PRESENTS:** That we, the undersigned: \_\_\_\_\_

Of the City of \_\_\_\_\_ Parish of \_\_\_\_\_, State of \_\_\_\_\_

As Principal, and \_\_\_\_\_, duly authorized under the Laws of the State of Louisiana to act as surety on bonds for the Principals, and as SURETY, are held and firmly bound unto the HOUSING AUTHORITY of the City of NEW ORLEANS, in Louisiana, a public body corporate and politic, created under and by virtue of the Laws of the State of Louisiana, (hereinafter referred to as the Local Authority) and to subcontractors, workmen, laborers, mechanics, furnishers of materials, and to all others entitled to protection under public Contract Bonds in accordance with the Laws of this State, the provisions of such Laws being incorporated herein by reference as their interest may appear, all of whom shall have the right to sue upon this Bond in the penal sum of:

\_\_\_\_\_ (\$\_\_\_\_\_)

**THE CONDITION OF THIS OBLIGATION IS SUCH THAT, WHEREAS,**

The above bounded Principal has on the \_\_\_\_\_ day of \_\_\_\_\_, 20\_\_\_\_, by an Instrument in writing, entered into a Contract with the Local Authority to furnish all materials, labor, tools, equipment, supervision, and other accessories, and to do all work necessary to complete the requirements within the Plans and Specifications for: \_\_\_\_\_, and Addenda thereto, numbered \_\_\_\_\_ Dated: \_\_\_\_\_ and, which said Specifications, Addenda and Drawings are incorporated herein by reference, and made a part hereof.

**NOW, THEREFORE,** if the said principal shall well and truly in good sufficient and workmanlike manner, faithfully perform said Contract and Agreement, and shall and will in all respects duly and faithfully perform all and singular the covenant-conditions and agreements in and by said Contract agreed and covenanted by the said Principal, to be observed and performed and according to the true intent and meaning of said Contract, Plans and Specifications thereunder perform and complete the work required, and shall defend, indemnify and save harmless said Local Authority against all damages, claims, demands, expenses, and charges of every kind

(including claims of patent infringement) arising out of injury or damage to persons or property by reason of said Contract and the work thereunder required of said Principal or arising from any act, omission or neglect of said Principal, his agents, or employees with relation to said work and shall pay all costs, charges, rentals, and expenses for labor, materials, supplies, and equipment, and deliver to the said Local Authority completed and ready for occupancy or operation and free from all liens, encumbrances, or claims for labor, materials or otherwise, during the original term of same, as well as during any period of extension of said Contract that may be granted on the part of the Local Authority; and shall promptly well and truly make payment to persons, firms, corporations, subcontractors, workmen, laborers, mechanics, furnishing materials for, or performing labor in prosecution of work provided in such Contract, all moneys to them owing by said Principal for subcontractor's work, labor and materials, workmen's compensation insurance, excise taxes or other lawful public charges, provided, furnished, or applicable to the construction of such improvements, provided in such Contract, for the said Local Authority and shall pay to the said Local Authority, all penalties provided for under the laws of this State for the violation of any provisions of law and/or of the provisions of said Contract, and shall pay all other expenses lawfully chargeable to the said Local Authority by reason of any default or neglect in the relation of said Contract and said work-then the obligation shall be and become null and void, otherwise to remain in full force and effect.

No modifications, omissions, or additions in or to the terms of said Contract, in the Plans and Specifications, or in the manner and mode of payment, shall in any manner affect the obligation of the undersigned Surety in connection with the aforesaid Contract.

The undersigned hereby does further consent and yield to the jurisdiction of the Civil District Court for the Parish of Orleans, in the State of Louisiana and does hereby formally waive any pleas of jurisdiction on account of the residence elsewhere of the undersigned Surety, as well as all pleas or discussions in regard to the Contractor, its Principal under this Bond.

**INVITATION FOR BIDS (IFB) No. 25-911-01 DOJ Repairs and Upgrades at Guste III Housing Community - Interior and Exterior (Re-Bid)**

**IN WITNESS WHEREOF**, the above bonded parties have executed this Instrument under their several  
Seals, and these presents duly signed by their undersigned representative pursuant to the authority of their  
governing bodies;

**IN THE PRESENCE OF:**

ATTEST:

\_\_\_\_\_  
\_\_\_\_\_

\_\_\_\_\_  
By: \_\_\_\_\_

Title: \_\_\_\_\_

Date: \_\_\_\_\_

BUSINESS ADDRESS:

\_\_\_\_\_  
\_\_\_\_\_  
\_\_\_\_\_

(Corporate Surety)

ATTEST:

\_\_\_\_\_  
\_\_\_\_\_

By: \_\_\_\_\_

Title: Attorney-in-Fact

Date: \_\_\_\_\_

BUSINESS ADDRESS:

\_\_\_\_\_  
\_\_\_\_\_  
\_\_\_\_\_

The rate of premium on this bond is \$ \_\_\_\_\_ per thousand

The total amount of premium is \$ \_\_\_\_\_

**HOUSING AUTHORITY OF NEW ORLEANS, LA**

---

# Attachment O

## Davis Bacon

## Wage Rates





"General Decision Number: LA20240001 10/04/2024

Superseded General Decision Number: LA20230001

State: Louisiana

Construction Type: Residential

Counties: Acadia, Ascension, Bossier, Caddo, Calcasieu, East Baton Rouge, Jefferson, Lafayette, Lafourche, Livingston, Orleans, Ouachita, Plaquemines, Rapides, St Bernard, St Charles, St James, St John the Baptist, St Landry, St Martin, St Tammany, Terrebonne, Webster and West Baton Rouge Counties in Louisiana.

RESIDENTIAL CONSTRUCTION PROJECTS (consisting of single family homes and apartments up to and including 4 stories)

Note: Contracts subject to the Davis-Bacon Act are generally required to pay at least the applicable minimum wage rate required under Executive Order 14026 or Executive Order 13658. Please note that these Executive Orders apply to covered contracts entered into by the federal government that are subject to the Davis-Bacon Act itself, but do not apply to contracts subject only to the Davis-Bacon Related Acts, including those set forth at 29 CFR 5.1(a)(1).

If the contract is entered into on or after January 30, 2022, or the contract is renewed or extended (e.g., an option is exercised) on or after January 30, 2022:	. Executive Order 14026 generally applies to the contract. . The contractor must pay all covered workers at least \$17.20 per hour (or the applicable wage rate listed on this wage determination, if it is higher) for all hours spent performing on the contract in 2024.
If the contract was awarded on or between January 1, 2015 and January 29, 2022, and the contract is not renewed or extended on or after January 30, 2022:	. Executive Order 13658 generally applies to the contract. . The contractor must pay all covered workers at least \$12.90 per hour (or the applicable wage rate listed on this wage determination, if it is higher) for all hours spent performing on that contract in 2024.

The applicable Executive Order minimum wage rate will be adjusted annually. If this contract is covered by one of the Executive Orders and a classification considered necessary for performance of work on the contract does not appear on this wage determination, the contractor must still submit a conformance request.

Additional information on contractor requirements and worker protections under the Executive Orders is available at

http://www.dol.gov/whd/govcontracts.

Modification Number	Publication Date
0	01/05/2024
1	01/12/2024
2	05/17/2024
3	06/14/2024
4	08/30/2024
5	10/04/2024

ELEC0130-003 12/04/2023

JEFFERSON, LAFOURCHE, ORLEANS, PLAQUEMINES, ST. BERNARD, ST. CHARLES, ST. JAMES, ST. JOHN THE BAPTIST, ST. MARTIN (Southern Portion), and TERREBONNE PARISHES

	Rates	Fringes
ELECTRICIAN (including low voltage wiring and installation of fire alarms and security systems).....	\$ 34.00	15.20

\* ELEC0194-002 09/02/2024

BOSSIER, CADD0, and WEBSTER PARISHES

	Rates	Fringes
ELECTRICIAN (including low voltage wiring and installation of fire alarms and security systems).....	\$ 34.00	15.22

ELEC0446-002 09/01/2023

OUACHITA PARISH

	Rates	Fringes
ELECTRICIAN (including low voltage wiring and installation of fire alarms and security systems).....	\$ 21.81	1.25%+13.00

ELEC0576-003 03/01/2024

RAPIDES PARISH

	Rates	Fringes
ELECTRICIAN (including low voltage wiring and installation of fire alarms and security systems).....	\$ 28.00	4.25%+10.10

\* ELEC0861-002 09/01/2024

ACADIA, CALCASIEU, LAFAYETTE, AND ST. MARTIN (Northern Portion) PARISHES

Rates	Fringes
-------	---------

ELECTRICIAN (including low voltage wiring and installation of fire alarms and security systems).....\$ 31.98 4.34%+13.75

-----  
ELEC0995-003 01/01/2024

ASCENSION, EAST BATON ROUGE, LIVINGSTON, ST. LANDRY, AND WEST BATON ROUGE PARISHES

Rates Fringes

ELECTRICIAN (including low voltage wiring and installation of fire alarms and security systems).....\$ 28.29 13.02

-----  
ELEC1077-006 05/27/2024

ST. TAMMANY PARISH

Rates Fringes

ELECTRICIAN (including low voltage wiring and installation of fire alarms and security systems).....\$ 28.84 3%+11.37

-----  
PLUM0060-005 06/05/2023

JEFFERSON, LAFOURCHE, ORLEANS, PLAQUEMINES, ST. BERNARD, ST. CHARLES, ST. JAMES (Southeastern Portion), ST. JOHN THE BAPTIST, ST. TAMMANY, AND TERREBONNE PARISHES

Rates Fringes

PLUMBER (including HVAC pipe)....\$ 31.70 13.85

-----  
PLUM0141-003 08/01/2023

BOSSIER, CADDO, and WEBSTER PARISHES

Rates Fringes

PLUMBER (including HVAC pipe)....\$ 28.48 14.47

-----  
PLUM0141-008 08/01/2024

OUACHITA PARISH

Rates Fringes

PLUMBER (including HVAC pipe)....\$ 28.75 11.86

-----  
PLUM0198-002 12/08/2022

ASCENSION, EAST BATON ROUGE, LIVINGSTON , ST. JAMES (Northwestern Portion), ST. MARTIN (Eastern Portion), AND WEST BATON ROUGE PARISHES

Rates Fringes

PLUMBER (including HVAC pipe)....\$ 32.42 16.50

-----  
PLUM0198-009 06/01/2014

ACADIA, CALCASIEU, LAFAYETTE, ST. LANDRY, and ST. MARTIN  
(Western Portion) PARISHES

Rates Fringes

PLUMBER (including HVAC pipe)....\$ 25.90 13.65

-----  
PLUM0247-004 05/01/2020

RAPIDES PARISH

Rates Fringes

PLUMBER (including HVAC pipe)....\$ 26.50 13.39

-----  
SHEE0214-003 07/01/2009

Jefferson, Lafourche, Orleans, Plaquemines, St. Bernard, St.  
Charles, St. James, St. John the Baptist, St. Tammany, and  
Terrebonne Parishes

Rates Fringes

SHEET METAL WORKER (includes  
HVAC Duct).....\$ 24.54 9.65

-----  
SHEE0214-005 02/01/2009

Acadia, Ascension, Calcasieu, East Baton Rouge, Lafayette,  
Livingston, St. Landry, St. Martin, and West Baton Rouge  
Parishes

Rates Fringes

SHEET METAL WORKER (includes  
HVAC Duct).....\$ 24.37 9.205

-----  
SHEE0361-004 07/01/2012

BOSSIER, CADDO, OUACHITA, RAPIDES, AND WEBSTER PARISHES

Rates Fringes

Sheet Metal Worker (including  
HVAC duct).....\$ 26.09 10.22+3%

-----  
\* SULA2004-012 06/15/2004

Rates Fringes

CARPENTER (including drywall  
hanging, metal stud  
installation, and  
formbuilding/formsetting).....\$ 11.78 \*\* 0.00

Laborer, common.....\$ 8.01 \*\* 0.00

PAINTER		
Brush, Roller, and Spray....	\$ 11.38 **	.83
Drywall Finishing.....	\$ 12.71 **	.78
Power Equipment Operator		
Crane.....	\$ 13.00 **	0.00
ROOFER.....	\$ 10.11 **	2.01

-----

WELDERS - Receive rate prescribed for craft performing operation to which welding is incidental.

=====

\*\* Workers in this classification may be entitled to a higher minimum wage under Executive Order 14026 (\$17.20) or 13658 (\$12.90). Please see the Note at the top of the wage determination for more information. Please also note that the minimum wage requirements of Executive Order 14026 are not currently being enforced as to any contract or subcontract to which the states of Texas, Louisiana, or Mississippi, including their agencies, are a party.

Note: Executive Order (EO) 13706, Establishing Paid Sick Leave for Federal Contractors applies to all contracts subject to the Davis-Bacon Act for which the contract is awarded (and any solicitation was issued) on or after January 1, 2017. If this contract is covered by the EO, the contractor must provide employees with 1 hour of paid sick leave for every 30 hours they work, up to 56 hours of paid sick leave each year. Employees must be permitted to use paid sick leave for their own illness, injury or other health-related needs, including preventive care; to assist a family member (or person who is like family to the employee) who is ill, injured, or has other health-related needs, including preventive care; or for reasons resulting from, or to assist a family member (or person who is like family to the employee) who is a victim of, domestic violence, sexual assault, or stalking. Additional information on contractor requirements and worker protections under the EO is available at <https://www.dol.gov/agencies/whd/government-contracts>.

Unlisted classifications needed for work not included within the scope of the classifications listed may be added after award only as provided in the labor standards contract clauses (29CFR 5.5 (a) (1) (iii)).

-----

The body of each wage determination lists the classification and wage rates that have been found to be prevailing for the cited type(s) of construction in the area covered by the wage determination. The classifications are listed in alphabetical order of ""identifiers"" that indicate whether the particular rate is a union rate (current union negotiated rate for local), a survey rate (weighted average rate) or a union average rate (weighted union average rate).

Union Rate Identifiers

A four letter classification abbreviation identifier enclosed in dotted lines beginning with characters other than ""SU"" or



""UAVG"" denotes that the union classification and rate were prevailing for that classification in the survey. Example: PLUM0198-005 07/01/2014. PLUM is an abbreviation identifier of the union which prevailed in the survey for this classification, which in this example would be Plumbers. 0198 indicates the local union number or district council number where applicable, i.e., Plumbers Local 0198. The next number, 005 in the example, is an internal number used in processing the wage determination. 07/01/2014 is the effective date of the most current negotiated rate, which in this example is July 1, 2014.

Union prevailing wage rates are updated to reflect all rate changes in the collective bargaining agreement (CBA) governing this classification and rate.

#### Survey Rate Identifiers

Classifications listed under the ""SU"" identifier indicate that no one rate prevailed for this classification in the survey and the published rate is derived by computing a weighted average rate based on all the rates reported in the survey for that classification. As this weighted average rate includes all rates reported in the survey, it may include both union and non-union rates. Example: SULA2012-007 5/13/2014. SU indicates the rates are survey rates based on a weighted average calculation of rates and are not majority rates. LA indicates the State of Louisiana. 2012 is the year of survey on which these classifications and rates are based. The next number, 007 in the example, is an internal number used in producing the wage determination. 5/13/2014 indicates the survey completion date for the classifications and rates under that identifier.

Survey wage rates are not updated and remain in effect until a new survey is conducted.

#### Union Average Rate Identifiers

Classification(s) listed under the UAVG identifier indicate that no single majority rate prevailed for those classifications; however, 100% of the data reported for the classifications was union data. EXAMPLE: UAVG-OH-0010 08/29/2014. UAVG indicates that the rate is a weighted union average rate. OH indicates the state. The next number, 0010 in the example, is an internal number used in producing the wage determination. 08/29/2014 indicates the survey completion date for the classifications and rates under that identifier.

A UAVG rate will be updated once a year, usually in January of each year, to reflect a weighted average of the current negotiated/CBA rate of the union locals from which the rate is based.

#### State Adopted Rate Identifiers

Classifications listed under the ""SA"" identifier indicate that the prevailing wage rate set by a state (or local) government was adopted under 29 C.F.R. 1.3(g)-(h). Example: SAME2023-007 01/03/2024. SA reflects that the rates are state adopted. ME refers to the State of Maine. 2023 is the year during which the state completed the survey on which the listed classifications and rates are based. The next number, 007 in the example, is an internal number used in producing the wage determination. 01/03/2024 reflects the date on which the classifications and rates under the ?SA? identifier took effect under state law in

the state from which the rates were adopted.

-----  
WAGE DETERMINATION APPEALS PROCESS

1.) Has there been an initial decision in the matter? This can be:

- \* an existing published wage determination
- \* a survey underlying a wage determination
- \* a Wage and Hour Division letter setting forth a position on a wage determination matter
- \* a conformance (additional classification and rate) ruling

On survey related matters, initial contact, including requests for summaries of surveys, should be with the Wage and Hour National Office because National Office has responsibility for the Davis-Bacon survey program. If the response from this initial contact is not satisfactory, then the process described in 2.) and 3.) should be followed.

With regard to any other matter not yet ripe for the formal process described here, initial contact should be with the Branch of Construction Wage Determinations. Write to:

Branch of Construction Wage Determinations  
Wage and Hour Division  
U.S. Department of Labor  
200 Constitution Avenue, N.W.  
Washington, DC 20210

2.) If the answer to the question in 1.) is yes, then an interested party (those affected by the action) can request review and reconsideration from the Wage and Hour Administrator (See 29 CFR Part 1.8 and 29 CFR Part 7). Write to:

Wage and Hour Administrator  
U.S. Department of Labor  
200 Constitution Avenue, N.W.  
Washington, DC 20210

The request should be accompanied by a full statement of the interested party's position and by any information (wage payment data, project description, area practice material, etc.) that the requestor considers relevant to the issue.

3.) If the decision of the Administrator is not favorable, an interested party may appeal directly to the Administrative Review Board (formerly the Wage Appeals Board). Write to:

Administrative Review Board  
U.S. Department of Labor  
200 Constitution Avenue, N.W.  
Washington, DC 20210

4.) All decisions by the Administrative Review Board are final.

=====  
END OF GENERAL DECISION"

# Attachment P

## Employment, Training, and Contracting Policy

**HANO**

*Housing Authority of New Orleans*



*Housing Authority of New Orleans*

**EMPLOYMENT, TRAINING, AND CONTRACTING POLICY**

# **Table of Contents**

**Page**

## **Part I- Policy, Purpose, Requirements, Definitions**

A. Introduction and Summary.....	3
B. Definitions.....	4
C. HANO Section 3 & DBE/WBE Policy Statements .....	6
D. Section 3 New Hire and Contracting Requirements.....	7
E. DBE/WBE Contract Requirements.....	9

## **Part II- Procurement & Contractor Requirements and Procedures**

A. Section 3 Contracting Procedures .....	10
B. DBE/WBE Contracting Procedures .....	12
C. Reporting Open Positions.....	14

## **Part III – Compliance Requirements**

A. Compliance Requirements for Hiring & Contracting .....	15
B. Project Labor Agreements or Community Workforce Agreements.....	15

## **Part VI – Training Requirements**

A. Training and Internship Requirements.....	16
--	----

## **Part V – Contracting and Compliance Forms**

A. Section -3 Individual Verification Form.....	18
B. Section -3 Employment Action Plan.....	21
C. Section -3 Training Action Plan.....	22
D. Contracting and Action Plan for Section 3/DBE/WBE.....	23
E. List of Core Employees.....	24
F. Contracting Schedule.....	25
G. Section -3 Employment and Training Schedule.....	26
H. Letter of Intent.....	27
I. Statement of Understanding.....	28
J. Contractors Section -3 Employment and Training Compliance Report.....	29
K. Employer Paid Training Report.....	30
L. Section -3 Manhour Report.....	31
M. Contracting Compliance Report.....	32
N. Employment Assessment.....	33



# Part I: Policy, Purpose, Requirements, Definitions

---

## A. Introduction and Summary

The Housing Authority of New Orleans (HANO) has established a policy whereby any contractor that transacts business with HANO must meet the requirements of HANO's Section 3 and DBE/WBE policy as outlined in this document. This policy applies to all contracts valued at \$100,000 or greater. Contractors will: 1) offer Section 3 employment, training and employment skill building programs for eligible Section 3 residents and 2) provide Section 3 Business Concerns, Disadvantaged Business Enterprises (DBEs) as well as Woman Business Enterprises (WBEs) with the maximum opportunity to participate in the performance of contracts awarded by HANO. HANO will make a good faith effort to recruit as many Section 3 eligible residents and businesses as possible for employment and instructional positions and contract opportunities, in an effort to provide economic opportunities for area residents and area business concerns.

This document serves to fulfill two (2) main objectives: 1) it outlines the Section 3 & Section 3 Business Concerns/DBE/WBE policy and program compliance measures of HANO, and 2) it contains program definitions, requirements, required forms, information on program assistance provided by HANO, and other information related to HANO's Employment, Training and Contracting Policy. This document replaces all previous policies and is in immediate effect as of the HANO Board approval date.

### Summary of Requirements

Requirements	Section 3 Hiring	Section 3 Training & Internship	DBE Contracting	WBE Contracting	Section 3 Contracting
	30% of new hires	Paid Training and Internship Spots as listed in Chart on Page 17	20% of the value of the contract	5% of the value of the contract	10% of the value of construction contracts  3% of the value of non-construction contracts

These requirements apply to all prime and subcontractors where the value of the contract with HANO is \$100,000 or greater.

## B. Definitions

**Local Hire:** Employee Residing within Orleans Parish.

**Low-Income Person:** A family (including single persons) whose income does not exceed 80% of the median income for the area, as determined by HUD, with adjustments for smaller and larger families.

**Very Low-Income Person:** A family (including single persons) whose income does not exceed 50% of the median family income for the area, as determined by HUD, with adjustments for smaller and larger families.

**New Hires:** Full-time employees not previously employed on this contract for permanent, temporary or seasonal employment opportunities.

**Section 3 Resident:** A public housing resident, (HCVP) Housing Choice Voucher Program Participant or an individual who is considered to be a low to very low income Orleans Parish Resident.

**Core Employees:** Persons listed and verified as employed with company before the contract execution date.

**Contractor:** Any entity which contracts for the performance of work generated by the expenditure of Section 3 covered assistance, or performing work in connection with a Section 3 covered project.

**Woman Business Enterprise (WBE):** A business enterprise that is 51% or more owned, controlled, and actively operated by one or more women.

**Disadvantaged Business Enterprise (DBE):** A business enterprise that is 51% or more owned, controlled, and actively operated by one or more persons who are classified as part of a socially and economically disadvantaged group. Such socially disadvantaged persons include African-Americans, Hispanic Americans, Native Americans, Eskimos, Aleuts, Hasidic Jewish Americans, Asian Pacific Americans and Asian Indian Americans.

**Housing Authority (HA):** Public Housing Agency

**Housing Development:** Housing owned, developed, or operated by public housing agencies in accordance with HUD's public housing program regulations codified in 24 CFR Chapter IX.

**Employment Opportunities Generated by Section 3 Covered Assistance:** All employment opportunities generated by the expenditure of Section 3 covered public assistance (i.e., operating assistance, development assistance and modernization assistance, (as described in 24 CFR Section 135.3 (a) (1)). With respect to Section 3 covered housing and community development assistance, this term means all employment opportunities arising in connection with Section 3 covered projects (as described in Section 135.3 (a) (2)), including management

and administrative jobs. Management and administrative jobs include architectural, engineering or related professional services required to prepare plans, drawings, specifications, or work write-ups; and jobs directly related to administrative support of these activities, e.g., construction manager, relocation specialist, payroll clerk, etc.

**HUD Youthbuild Programs:** Programs that receive assistance under subtitle D of Title IV of the National Affordable Housing Act, as amended by the Housing and Community Development Act of 1992 (42 U.S.C. 12899), and provide disadvantaged youth with opportunities for employment, education, leadership development, and training in the construction or rehabilitation of housing for homeless individuals and members of low- and very low-income families.

**Recipient:** Any entity which receives Section 3 covered assistance, directly from HUD or from another recipient and includes, but is not limited to, any State unit of local government, PHA, or other public body, public or private nonprofit organization, private agency or institution, mortgagor, developer, limited dividend sponsor, builder, property manager, community housing development organization, resident management corporation, resident council, or cooperative association. Recipient also includes any successor, assignee or transferee of any such entity, but does not include any ultimate beneficiary under the HUD program to which Section 3 applies and does not include contractors.

**Section 3:** Section 3 of the Housing and Urban Development Act of 1968, as amended (12 U.S.C. 1701u).

**Section 3 Business Concern:**

- (1) Business concerns that are 51% or more owned by residents of the housing development or developments for which the section 3 covered assistance is expended; or
- (2) Business concerns whose full-time, permanent workforce includes 30% of public housing residents or low or very low income local residents as employees; or
- (3) HUD Youthbuild programs being carried out in the area in which the section 3 covered assistance is expended; or
- (4) Business concerns that subcontract in excess of 25% of the total amount of subcontracts to business concerns identified in paragraphs (1) and (2) of this section.

**Section 3 Covered Contracts:** A contract or subcontract (including a professional service contract) awarded by a recipient or contractor for work generated by the expenditure of Section 3 covered assistance, or for work arising in connection with a Section 3 covered project. Section 3 covered contracts do not include contracts awarded under HUD's procurement program, which are governed by the Federal Acquisition Regulation (FAR). Section 3 covered contracts also do not include contracts for the purchase of supplies and materials only. However, whenever a contract for materials includes the installation of the materials, the contract constitutes a Section 3 covered contract.

**Section 3 Covered Project:** The construction, reconstruction, conversion or rehabilitation of housing (including reduction and abatement of lead-based paint hazards), other public construction which includes buildings or improvements (regardless of ownership) assisted with housing or community development assistance.

**Subcontractor:** Any entity (other than a person who is an employee of the contractor) which has a contract with a contractor to undertake a portion of the contractor's obligation for the performance of work generated by the expenditure of Section 3 covered assistance, or arising in connection with a Section 3 covered project.

### C. HANO Section 3 & DBE/WBE Policy Statements

#### i. **Section 3 Policy Statement**

Section 3 of the Housing and Urban Development Act of 1968, as amended (12 U.S.C. 1701, et seq.) (the "Act") requires the Housing Authority of New Orleans to ensure that employment and other economic and business opportunities generated by financial assistance from the Department of Housing and Urban Development ("HUD"), are directed to public housing residents and other low income persons, particularly recipients of government housing assistance, and business concerns that provide economic opportunities to low and very low income persons.

With the Housing Authority of New Orleans' (HANO) Board Resolution Number 2012-05, HANO hereby reaffirms its commitment of ensuring that all contractors and any tier subcontractors that are awarded a contract of \$100,000 or greater by HANO for work generated through the expenditure of HUD funding shall take all necessary and reasonable steps to provide meaningful, full-time, permanent employment and training to Section 3 residents. It is further reaffirmed that all vendor/contractors and any tier subcontractors that are awarded a contract of \$100,000 or greater for work generated through the expenditure of HUD funding shall take all necessary and reasonable steps to provide contracting opportunities to Section 3 business concerns.

To comply with the Act and Board Resolution Number 2012-05, the requirements of this policy is to obtain a reasonable level of success in the recruitment, employment, and utilization of HANO residents and other eligible persons and/or businesses by contractors working on contracts partially or wholly funded with HUD monies. HANO shall examine and consider a contractor's potential for success in providing employment and business opportunities to those covered under Section 3 prior to acting on any proposed contract award.

In response to any Request for Proposals (RFP), Request for Qualifications (RFQ) or Invitation for Bids (IFB), HANO will require submission of the Section 3 Opportunities Plan, roster of Core Employees, and certification that the respondent will comply with the requirements of Section 3 and this policy.

HANO, in accordance with applicable laws and regulations, has established employment and training requirements that contractors and subcontractors are expected to meet in order to comply with Section 3 requirements. ***HANO's Section 3 requirement is thirty percent (30%) of any new hires for the term of the contract shall be Section 3 eligible workers, and 10% (construction) or 3% (non-construction) of the value of the contract shall be awarded to Section 3 eligible Businesses.*** It is the contractor's responsibility to implement progressive efforts to attain Section 3 compliance. Failure to attain Section 3 compliance in accordance with their contract will subject them to penalties including, but not limited to, the withholding of payments.

ii. **DBE/WBE Policy Statement**

Consistent with Presidential Executive Orders 11625, 12138, and 12432, and as promulgated in 24 CFR Part 85 and in the Housing Authority of New Orleans' (HANO) Board Resolution Number 2012-05, HANO hereby modifies the numerical requirements relative to contracting with Disadvantaged Business Enterprises (DBEs) and Woman Business Enterprises (WBEs) and reaffirms its commitment of ensuring that all contractors and any tier subcontractors that are awarded a contract of \$100,000 or greater for work generated through the expenditure of HUD funding shall take all necessary and reasonable steps to provide Disadvantaged Business Enterprises (DBEs) and Woman Business Enterprises (WBEs) with the maximum opportunity to participate in the performance of contracts awarded by HANO.

***HANO's DBE requirement is 20% of the value of the contract will be awarded to DBEs and 5% of the value of the contract will be awarded to WBEs.***

To comply with this requirement and Board Resolution Number 2012-05, the requirements of this policy is to obtain a reasonable level of success in the utilization of eligible businesses by contractors working on contracts partially or wholly funded with HUD monies. HANO shall examine and consider a contractor's potential for success in meeting these requirements prior to acting on any proposed contract award.

In response to any Request for Proposals (RFP), Request for Qualifications (RFQ) or Invitation for Bids (IFB), HANO will require submission of evidence and certification that the bidder will comply with the requirements of this policy.

## **D. Section 3 New Hire & Contracting Requirements**

### **Section 3 Numerical Requirements and Order of Preference:**

In accordance with Section 3, HANO requires that all contractors and any tier subcontractors shall provide training and employment opportunities to Section 3 residents to meet or exceed a numerical requirement of 30% of all new hires.

HANO has established employment and training requirements that contractors and subcontractors are expected to meet in order to comply with Section 3 requirements. It is the contractor's responsibility to implement progressive efforts to attain Section 3 compliance.



### **Section 3 Hiring Preference**

Contractors shall adhere to the following order of priority for employment purposes:

- Priority 1: A low or very low-income resident of HANO housing site where the work is being done
- Priority 2: A low or very low-income resident of any HANO housing developments
- Priority 3: A participant in HUD Youthbuild program in Orleans Parish
- Priority 4: HANO Housing Choice Voucher Participant
- Priority 5: a) A Very low-income resident of Orleans Parish  
b) A Low-Income resident of Orleans Parish

### **Contracting Requirements**

In accordance with Section 3, HANO requires that all contractors and any tier subcontractors shall direct 10% of the contract value to Section 3 business concerns for construction contracts and 3% for non-construction contracts in the following order of priority:

- Priority 1: Business concerns that are 51% or more owned by residents of the HANO housing development or developments for which the Section 3 covered assistance is expended, or whose full-time, permanent workforce includes 30% of these persons as employees; or
- Priority 2: Business concerns that are 51% or more owned by residents of other HANO housing developments that is expending the Section 3 covered assistance, or whose full-time, permanent workforce includes 30% of these persons as employees; or
- Priority 3: HUD Youthbuild programs in Orleans Parish; or
- Priority 4: Business concerns that are 51% or more owned by low or very-low income Section 3 Orleans Parish residents, or whose permanent, full-time workforce includes no less than 30% Section 3 residents, or that subcontract in excess of 25% of the total amount of subcontracts to business concerns identified in paragraphs (1) and (2) of this section.

Section 3 businesses seeking a contract or subcontract shall be responsible for submitting evidence, if requested, to demonstrate to the satisfaction of the contracting party that the business concern is responsible and has the ability to perform successfully under the terms and conditions of the proposed contract.

Contractors must incorporate and enforce the provisions of the Section 3 policy and numerical requirements in any and all tier subcontracts. Requirements relative to employment and contracting with Section 3 residents and business concerns shall not apply to contracts less than \$100,000 and shall not apply to contracts for the purchase of supplies and materials unless the contract for materials includes installation.

In some instances, the requirements relative to contracting with Section 3 business concerns and DBEs/WBEs may overlap; however, **participation can only count toward one requirement.** For example, if a subcontract is let to a Section 3 business concern that also qualifies as a DBE, then the contractor may count the subcontract either towards its Section 3 contracting requirements or towards its DBE contracting requirements; the contractor shall not be allowed to count the participation towards both requirements.

## **E. DBE/WBE Contract Requirements**

### **Numerical Requirements**

HANO requires that all contractors and any tier subcontractors shall direct their subcontracting opportunities to DBEs/WBEs as follows:

- Disadvantaged Business Enterprises - 20% of the total value of contract
- Woman Business Enterprises - 5% of the total value of contract

DBE and WBE businesses seeking a contract or subcontract shall be responsible for submitting evidence, if requested, to demonstrate to the satisfaction of the contracting party that the business concern is responsible and has the ability to perform successfully under the terms and conditions of the proposed contract.

Contractors must incorporate and enforce the provisions of this policy and numerical requirements in any and all tier subcontracts.

In some instances, the requirements relative to contracting with Section 3 business concerns and DBEs/WBEs may overlap; however, a individual companies participation can only count toward one requirement on a contract. For example, if a subcontract is let to a WBE concern that also qualifies as a DBE, then the contractor may count the subcontract either towards its WBE contracting requirements or towards its DBE contracting requirements; the contractor shall not be allowed to count the participation towards both requirements.

Requirements relative to contracting with DBEs/WBEs shall not apply to contracts less than \$100,000 and shall not apply to contracts where the contractor is not subcontracting for any work, materials, supplies, services, etc, or when the sole source or specified items are not available from DBEs/WBEs.

100% of the participation of DBE/WBE suppliers shall count towards the requirements as long as the supplier maintains an inventory and/or significantly alters the product for distribution. In cases where the DBE/WBE supplier does not maintain an inventory and/or does not significantly alter products for distribution, only 25% of the DBE/WBE supplier's participation shall count toward the requirements.

## **Part II- Procurement & Contractor Requirements and Procedures**

---

### **A. Section 3 Contracting Requirements & Procedures**

The procedures outlined herein shall apply to all contractors seeking contracting opportunities with the Housing Authority of New Orleans.

As part of the response to an IFB, RFP, RFQ, or other solicitation, respondents (prime) are required to submit a Section 3 Employment and Training Action Plan (SETAP) to identify overall projected employment by type and phase, Section 3 hiring, training and contracting requirements, objectives, and actions that will be implemented to ensure compliance with the requirements of Section 3. (See Section III for Section 3 Employment & Training Action Plan format).

The **HANO Section 3 Coordinator** will be responsible for coordinating with the Department of Procurement and Contracts to review the Section 3 Employment and Training Action Plan prior to the award of the contract. Upon selection, HANO will work with the selected firm to finalize the Section 3 Plan, including identification of HANO assistance to be provided (if any), timelines for action, and review of reporting and compliance requirements. The Section 3 Employment and Training plan is separate and apart from the Disadvantaged/Women Business Enterprise Plan and must be completed in addition to the DBE/WBE Plan.

**I. Prior to Bid/Pre Certification Process:** HANO Resident-Owned Businesses can Visit [www.hano.org](http://www.hano.org), to complete and submit a Section 3 Business Concerns Application.

**II. Bid/Proposal Phase:** Contractors submitting bids and/or proposals to HANO shall be required to complete and submit the following forms (Appendix):

- Section 3 Employment Action Plan
- Section 3 Training Action Plan
- Section 3 Contracting Action Plan
- Section 3 Employment and Training Schedule
- List of Core Employees (including date of hire for each core employee and address)
- Contracting Schedule
- Letter of Intent
- Statement of Understanding

**III. Pre-Award Phase:** Subsequent to the submission of bids/proposals, but prior to contract award, contractors may be requested to provide additional information regarding the submissions required in the Bid/Proposal Phase. Such requests may be made in instances where the contractor does not show sufficient detail in their required Action Plans, where the contractor's required Schedules do not reflect achievement of the minimum stated requirements, where the contractor has not identified the name of the Section 3 subcontractor(s) in the required Schedules and does not have signed Letters of Intent, or where it is deemed necessary by HANO's Section 3 Coordinator.

#### **IV. Contract Performance Phase:**

##### **Section 3 Contract Performance Monitoring**

HANO shall monitor and evaluate the contractor's Section 3 compliance towards achieving the numerical requirements relative to Section 3 employment, training, and contracting throughout the contract period. The contractor shall be responsible for providing the following reports to HANO, which shall be submitted no later than 4:30 p.m., on the first business day of each month throughout the contract period (Appendix):

- Core Employee List Subcontractors / New Contracts
- Section 3 Employment and Training Compliance Reports
- Section 3 Manhour Report
- Contracting Compliance Report
- Section 3 Income Verification Form
- Employer Paid Training Report

Upon HANO's request, the contractor and all tier level sub-contractors are required to provide supporting documentation and proof of previous employment of any and all core employees prior to working on a HANO project.

The contractor shall also ensure that for each Section 3 resident hired, a Section 3 Verification Form is completed. The Section 3 Income Verification Form shall be completed by the resident, and submitted to the contractor. This documentation should be included with the monthly reports submitted to HANO.

The contractor shall be responsible for monitoring the compliance of any tier subcontractors. In doing so, the contractor shall require monthly reports, in the formats provided, from its lower tier subcontractors.

##### **Determination of Compliance**

Contractors and their subcontractors are required to demonstrate compliance with the Section 3 employment and contracting requirements by meeting the numerical requirements set forth above. Contractors who do not meet the contracting numerical requirements must thoroughly document its inability to comply. In addition, HANO requires contractors that fail to meet the contracting requirements set forth in this policy use the alternative measures listed on page 16 to comply. Contractor's efforts shall be directed towards identifying methods to achieve success under this program through the following requirements:

Hiring:

- Target recruitment of Section 3 residents for training and employment by taking steps such as:
  - Prominently place a notice of commitments under Section 3 at the project site or other places where applications for training and employment are taken;

- Contact HANO, HANO resident councils, HANO resident management corporations, and HANO residents;
  - Consider contracting with HANO Resident Councils and/or Resident Management Corporations
  - Contact HANO for a list of agencies which may be able to provide assistance regarding opportunities for training which can be utilized on this contract;
  - Contact local job training centers, employment service agencies, and community organizations;
  - Develop on-the-job training opportunities or participate in job training programs;
  - Develop or participate in certified Pre-Apprenticeship/Apprenticeship Trainings Programs for construction trades on Construction Contracts and Paid Internship/Summer Employment Opportunities for Non-Construction Contracts.
  - Advertise in the local media.
- Keep a list of Section 3 area residents who apply on their own or by referral for available positions.
  - Send to labor organizations or representatives of workers with whom the recipient, contractor, or subcontractor has a collective bargaining agreement or other understanding, a notice about contractual commitments under Section 3.
  - Select Section 3 area residents, particularly HANO residents, for training and employment positions.
  - Provide ongoing monitoring of the program by the contractor and its subcontractors to ensure compliance and to identify problems or difficulties in meeting the requirements, and implement strategies to overcome the problems. Where problems or difficulties in meeting the requirements are encountered, take aggressive efforts to rectify the matter. Such action shall include, but not be limited to, convening a meeting with HANO to advise it of the problems and proposed solutions. HANO will offer its assistance whenever possible.

Where feasible, adjust the initial Section 3 and DBE/WBE Action Plan to increase the use of Section 3 residents in categories where the Plan has been successful to compensate for those categories of lower success.

## **B. DBE/WBE Certification**

Businesses wishing to participate in HANO contracts as DBEs/WBEs must be certified by HANO's Section 3/DBE/WBE Coordinator, in the Department of Client Services. Businesses claiming DBE/WBE status must be certified in order to have their participation counted toward the contracting requirements stated herein. Interested businesses must initiate the certification process by submitting an application for certification to the Housing Authority. Applications for certification may be obtained by visiting HANO's website at [www.hano.org](http://www.hano.org).



**Contracting Procedures:**

The procedures outlined herein shall apply to all contractors seeking contracting opportunities with the Housing Authority of New Orleans.

**I. Prior to Bid/Pre Certification Process:** If qualified, contractors can visit [www.hano.org](http://www.hano.org), to complete and submit a Disadvantaged Business Enterprise Program Certification Application.

**II. Bid/Proposal Phase:** Contractors submitting bids and/or proposals to HANO shall be required to complete and submit the following forms (Appendix):

- A. DBE/WBE Contracting Action Plan
- B. Contracting Schedule
- C. Letter of Intent
- D. Statement of Understanding

**III. Pre-Award Phase:** Subsequent to the submission of bids/proposals, but prior to contract award, contractors may be requested to provide additional information regarding the submissions required in the Bid/Proposal Phase. Such requests may be made in instances where the contractor does not show sufficient detail in their required Action Plans, where the contractor's required Schedules do not reflect achievement of the minimum stated requirements, where the contractor has not identified the name of the DBE/WBE subcontractor(s) in the required Schedules and does not have signed Letters of Intent, or where it is deemed necessary by HANO's Compliance Officer.

**IV. Contract Performance Phase:** HANO shall monitor and evaluate the contractor's compliance towards achieving the numerical requirements relative to DBE/WBE contracting throughout the contract period. The contractor shall be responsible for providing the following reports to HANO, which shall be submitted no later than 4:30 p.m., on the tenth business day of each month throughout the contract period:

- Contracting Compliance Report

The contractor shall be responsible for monitoring the compliance of any tier subcontractors. In doing so, the contractor shall require monthly reports, in the formats provided, from its lower tier subcontractors.

**Contracting:**

- Target recruitment of DBEs/WBEs by taking such steps as:
  - Contact DBEs/WBEs in the HANO's directory;
  - Prominently place a notice of commitment relative to DBE/WBE contracting at the project site and other appropriate places;
  - Contact HANO for a list of certified firms;
  - Contact other organizations which might be helpful in identifying DBEs/WBEs;

- Advertise in the local media.
- Make every effort to use DBEs/WBEs included in HANO's directory of certified firms. Such efforts may include, but are not limited to:
  - Dividing total work into smaller sub-tasks (i.e. by floor);
  - Using multiple firms for the same type of work (i.e. two drywall subcontractors or several plumbing suppliers);
  - Exercise flexibility in utilizing DBEs/WBEs in other or additional areas than initially proposed if necessary to meet the program objectives.
- Provide ongoing monitoring of the program by the contractor and its subcontractors to ensure compliance and to identify problems or difficulties in meeting the requirements, and implement strategies to overcome the problems. Where problems or difficulties in meeting the requirements are encountered, take aggressive efforts to rectify the matter. Such action shall include, but not be limited to convening a meeting with HANO to advise it of the problems and proposed solutions. HANO will offer its assistance whenever possible.
- Where feasible, adjust the initial DBE/WBE Contracting Action Plan to increase the use of Section 3 business concerns in categories where the Plan has been successful, to compensate for those categories of lower success.

### C. Reporting Open Positions

All HANO contractors and subcontractors are required to report all job openings in connection with a contract resulting from any solicitation on [crescentcityjobmatch.com](http://crescentcityjobmatch.com), HANO's website and to the onsite/project Section 3 Coordinator as soon as the job becomes available. This will aid in fulfilling the dual requirements of the shared job database by connecting low-income residents in need of employment with contractors seeking to hire Section 3 employees. Noncompliance with HANO's requirement may result in sanctions, termination of the contract for default, and debarment or suspension from future HANO contracts.

\* For Construction Projects – All new hires must go through the on-site hiring process with the Section 3 Coordinator

## Part III- Compliance Requirements

---

### Compliance Requirements for Section 3/DBE/WBE Contracting

If a contractor or subcontractor cannot meet the Section 3, DBE, WBE contracting requirements it must thoroughly document its inability to comply. In addition, HANO requires contractors that fail to meet the contracting requirements set forth in this policy use the following alternative measures to comply:

- Contractors must contribute to HANO's Section 3 Training Fund, which provides training and other economic opportunities for HANO residents:
  - **Trade, Construction and Rehab Contractors must contribute 2% of the total contract amount.**
  - **Non-Construction Contractors (e.g. A&E, Consulting, Professional Services, Technical) must contribute 1% of the total contract amount.**

HANO will primarily use the Section 3 Training Fund to pay for resident self-sufficiency programming through HANO's partnerships with Local Colleges, State Approved Trade Programs, paid Work Experience /Internship Programs, Youth Summer Employment Programs and various other employment and training programs for residents. The site in which the construction or project is occurring will receive a portion of funds generated from that respective site for programs and equipment related to resident training.

### Compliance Requirement for Project Labor Agreements or Community Workforce Agreements

HANO shall require that a Project Labor Agreement or Community Workforce Agreement be entered into between the trade unions and the developer, contractor, and subcontractors for all projects whose collective value under HANO contracts is \$25 million or more. The Project Labor Agreement or Community Workforce Agreement shall comply with all requirements of the HANO Section 3 and DBE/WBE Employment, Training, and Contracting Policy dated March 13, 2012. The unions, developers, contractors, and subcontractors shall consult with HANO, resident leaders, and community stakeholders on the terms of the agreement prior to its execution.

## Part IV – Training Requirements

### Training Requirements for Construction Contracts

- HANO requires all construction contracts that are greater than (\$100,000.00) one hundred thousand dollars in total construction cost and is anticipated to exceed 6 months of construction; to include a detailed and well defined plan on how they will provide a certified pre-apprenticeship or apprenticeship training programs to at least (1) one Section 3 Resident in its priority order. (1) One additional Section 3 Resident in its priority order will be provided training for every additional (\$500,000) five hundred thousand to (\$1,000,000.00) one million dollars of the total contract value. The training plan and trainings must be aligned with the scope of work in the contract and approved by HANO. A training program participant can only count for (1) one training slot per total contract amount. Those who do not offer a certified pre-apprenticeship or apprenticeship training program will contribute into the HANO Section 3 Training Fund as prescribed in the chart listed below.

### Training Requirements for Non-Construction Contracts

- HANO requires that all non-Construction contracts that meet or exceed (\$100,00.00) one hundred thousand dollars in total contract value include a detailed and well defined plan to provide paid internship or summer employment opportunities to Section 3 Residents in its priority order. An internship/summer employment program participant can only count for (1) one internship/summer employment slot per total contract amount. Those who do not offer a HANO approved paid internship or summer employment opportunity will contribute into the HANO Section 3 Training Fund as prescribed in the chart listed below.

\* A Portion of All Funds Generated at A HANO Housing Site Will Remain At That Site for Resident Training Programs and Equipment

Total Contract Amount	Number of Section 3 Training / Internship Slots	Contribution to HANO Training Fund if Training or Internship Slots Are not Available
At least \$100,000, but less than \$500,000	1	6% of the Total Contract Value up to \$25,000
At least \$500,000, but less than \$1,000,000	2	5% of the Total Contract Value up to \$40,000
At least \$1,000,000, but less than \$2,000,000	3	4% of the Total Contract Value up to \$60,000
At least \$2,000,000, but less than \$4,000,000	4	3% of the Total Contract Value up to \$80,000
At least \$4,000,000, but less than \$7,000,000	10	2% of the Total Contract Value up to \$105,000
\$7,000,000 or more	1 additional training slot for every additional \$500,000.00	1.5% of that Total Contract Value, with no dollar limit

**Part V – Contracting and Compliance Forms**

---





## Housing Authority of New Orleans Section 3 Individual Verification Form

The following information will be used to verify your individual eligibility under the Section 3 regulations as set forth in 24 CFR Part 135.

A Section 3 resident seeking the preference in training and employment shall certify and submit evidence to demonstrate Section 3 eligibility.

I, \_\_\_\_\_, residing at \_\_\_\_\_  
(print name) (address)  
\_\_\_\_\_ have a family size of \_\_\_\_\_ and my total  
(city, state, zip code)  
annual income for the prior calendar year (20\_\_ ) was \$ \_\_\_\_\_ as is evidenced by the attached documentation.

**HANO Client Status** (Check ONLY One of the Following)

- I live in Public Housing at \_\_\_\_\_ (insert development name)
- I am a Housing Choice Voucher recipient
- None of the above

**Proof of income and residency is a requirement for an individual to become Section 3 certified.**

**Proof of residency** (Check at least one and provide a copy with this form):

- Copy of current lease
- 2 Utility Bills for the past 2 months (Utility bills must be in the name as shown above)
- Notarized statement from an individual with at least one of the above documents in their name attesting that the person seeking Section 3 Certification is living at their residence
- One of the acceptable proofs of income listed below
- Valid Federal or State ID

**Proof of income** (Check at least one and provide a copy with this form):

- Copy of receipt of public assistance
- Copy of Evidence of participation in a public assistance program
- Proof of income (Check stub, W-2, Tax forms, 1099, employer letter on letterhead, etc.)
- Proof of Unemployed Status
- I Have Zero Income and did not receive any form of subsidy during the calendar year listed above

I have voluntarily provided the above information in conjunction with employment on a HANO related project. I attest to the truthfulness of my statements fully understanding that this information is subject to verification by the appropriate federal agencies.

Signature \_\_\_\_\_ Date \_\_\_\_\_

Contact Phone: \_\_\_\_\_

Title 18, Section 1001 of the U.S. Code states that a person is guilty of a felony for knowingly and willingly making false or fraudulent statements to any department of the United States Government.

Willful falsification of any of the above statements may subject the contractor or subcontractor to civil or criminal prosecution. See Section 1001 of Title 18 and Section 231 of Title 31 of the U.S. Code.

**Section 3 Individual Verification Form  
(Part B)  
SECTION 3 REQUIREMENTS**

Consistent with the requirements of Section 3 of the Housing and Urban Development Act of 1968, as amended (12 U.S.C. 1701u) and with the Housing Authority of New Orleans' (HANO) Board Resolution Number 2012-05, HANO hereby reaffirms its commitment of ensuring that all contractors and any tier subcontractors that are awarded a contract in excess of \$100,000.00 by HANO for work generated through the expenditure of HUD funding shall take all necessary and reasonable steps to provide meaningful, full-time, permanent employment and training to Section 3 residents. It is further reaffirmed that all contractors and any tier subcontractors that are awarded a contract in excess of \$100,000.00 by HANO for work generated through the expenditure of HUD funding shall take all necessary and reasonable steps to provide business opportunities to Section 3 business concerns.

**Definitions:**

**Low-Income Person:**

A family (including single persons) whose income does not exceed 80% of the median income for the area, as determined by the Secretary, with adjustments for smaller and larger families.

**Very Low-Income Person:**

A family (including single persons) whose income does not exceed 50% of the median family income for the area, as determined by the Secretary, with adjustments for smaller and larger families.

**New Hires:**

Full-time employees for permanent, temporary or seasonal employment opportunities.

**Section 3 Resident:**

- 1) A low or very low income resident of HANO housing site where the work is being done; or
- 2) A low or very low income resident of any HANO housing site; or
- 3) A participant in HUD Youthbuild program in Orleans Parish; or
- 4) A HANO Housing Choice Voucher Participant
- 5) a) A very low-income resident of Orleans Parish  
b) A low-income resident of Orleans Parish

**Statement of Numerical Requirements and Order of Preference:**

In accordance with Section 3, HANO requires that all contractors and any tier subcontractors shall provide training and employment opportunities to Section 3 residents to meet or exceed a numerical requirement of 30% of all new hires in the following order of priority:

- Priority 1: A low or very low income resident of HANO housing site where the work is being done
- Priority 2: A low or very low income resident of any HANO housing site
- Priority 3: A participant in HUD Youthbuild program in Orleans Parish
- Priority 4: A HANO Housing Choice Voucher Participant
- Priority 5: a) A very low-income resident of Orleans Parish  
b) A low-income resident of Orleans Parish



**Section 3 Individual Verification Form  
(Part C)  
ORLEANS PARISH, LOUISIANA  
SECTION 3 ANNUAL FAMILY INCOME LIMITS 2015**

Orleans Parish Median Income: \$60,000

FY 2015 Income Limit Category	1 Person	2 Person	3 Person	4 Person	5 Person	6 Person	7 Person	8 Person
<u>Very Low (50%) Income Limits</u>	21,000	24,000	27,000	<b>30,000</b>	32,400	34,800	37,200	39,600
<u>Low (30%) Income Limits</u>	12,600	15,930	20,090	<b>24,250</b>	28,410	32,570	37,200	39,600
<u>Low (80%) Income Limits</u>	33,000	38,400	43,200	<b>48,000</b>	51,850	55,700	59,550	66,400

**Definition of Section 3 Resident:**

- 1) A Low or Very Low-Income Resident of HANO housing site where the work is being done; or
- 2) A Low or Very Low-Income Resident of any HANO housing site; or
- 3) A participant in a HUD Youthbuild program in Orleans Parish; or
- 4) A HANO Housing Choice Voucher Participant
- 5)
  - a) A very low-income resident of Orleans Parish (one whose family income does not exceed the limits outlined above).
  - b) A low-income resident of Orleans Parish (one whose family income does not exceed the limits outlined above).

\*Source – HUD FY 2015 Income Limits Documentations System, <http://www.huduser.org/portal/datasets/il/il2015/2015summary.odn>









HOUSING AUTHORITY OF NEW ORLEANS

CONTRACTING ACTION PLAN FOR SECTION 3/DBE/WBE

(FINAL PLAN WILL BE INCORPORATED INTO CONTRACT, IF AWARDED. )

Provide a written Plan describing the process and steps that will be taken to ensure that the requirements relative to contracting with Section 3 businesses, Minority and Women Business Enterprises will be met. Include in the description what specific actions will be taken to ensure that subcontractors comply with the requirements. The description must outline specific steps to be taken and detail the program or strategy to be employed to achieve the requirements. Provide an outline of the specific contracts that will be awarded to Section 3/DBE/WBE businesses, if known. Use additional sheets of paper, if necessary.

Lined area for writing the contracting action plan.

NOTE: This plan shall incorporate actions to be taken by the bidder's/offeror's proposed subcontractors/suppliers.

Name: \_\_\_\_\_ Title: \_\_\_\_\_ Date: \_\_\_\_\_





**HOUSING AUTHORITY OF NEW ORLEANS**

**CONTRACTING SCHEDULE**

Contracting Schedules that do not reflect a level of participation that meets or exceeds the stated requirements may cause the bid to be deemed non-responsive. Section 3, DBE, and WBE firms not certified by HANO shall not be included on this schedule and shall not be counted towards the participation requirements. Duplicate form if additional space is needed.

ITEM #	DESCRIPTION OF WORK TO BE PERFORMED	NAME AND ADDRESS OF COMPANY TO BE USED TO PERFORM THE WORK	TYPE OF WORK TO BE PERFORMED			TOTAL ESTIMATED AMOUNT OF WORK TO BE PERFORMED		
			LABOR	MATERIALS	BOTH	SECTION 3	DBE	WBE
EXAMPLE	PAINING	John Doe Resident Owned Painter, Inc. New Orleans, LA			X	\$50,000		
1.								
2.								
3.								
4.								
5.								
6.								
7.								

**Summary:**

- 1) Total Amount to be Awarded to Section 3 Business Concern: \$ \_\_\_\_\_ Percentage of Total Contract Amount \_\_\_\_\_%
- 2) Total Amount to be Awarded to DBE: \$ \_\_\_\_\_ Percentage of Total Contract Amount \_\_\_\_\_%
- 2) Total Amount to be Awarded to WBE: \$ \_\_\_\_\_ Percentage of Total Contract Amount \_\_\_\_\_%

Name: \_\_\_\_\_ Title: \_\_\_\_\_ Date: \_\_\_\_\_





HOUSING AUTHORITY OF NEW ORLEANS

LETTER OF INTENT – Subcontractor Commitment Form

To: \_\_\_\_\_ IFB# \_\_\_\_\_  
Name of Prime Contractor

The undersigned will enter into a signed agreement with the Prime Contractor listed above. Copies of agreements including, but not limited to joint ventures, subcontracts, supplier agreements or purchase orders referencing the IFB, RFP, RFQ, or Purchase Order Number shall be forwarded to HANO at:

Housing Authority of New Orleans  
4100 Touro Street  
New Orleans, Louisiana 70122  
Attn: Section 3/DBE/WBE Coordinator

Name of Subcontractor \_\_\_\_\_

Description of Work to Be Performed by Subcontractor \_\_\_\_\_

Contract Value (inclusive of change orders) \$ \_\_\_\_\_

Term of Contract (include start and end dates) \_\_\_\_\_

Subcontractor Status (Section 3, DBE, WBE) \_\_\_\_\_

By: \_\_\_\_\_  
Prime Contract Signature

\_\_\_\_\_  
Printed or Typed Name

Title: \_\_\_\_\_

Date: \_\_\_\_\_

If a corporate seal is not affixed, this document must be notarized. Provide Letter of Intent on Company Letterhead.

Subscribed and sworn to \_\_\_\_\_ (Notary Public)  
(Seal)  
before me this \_\_\_\_\_ day of \_\_\_\_\_, 20\_\_\_\_

My Commission expires: \_\_\_\_\_

Date Executed: \_\_\_\_\_





HOUSING AUTHORITY OF NEW ORLEANS

STATEMENT OF UNDERSTANDING

IFB NO. \_\_\_\_\_

Under penalties of perjury, as prescribed in 18 U.S.C. 1001, the undersigned certifies that it:

- o Has prepared and submitted its bid/proposal to HANO with a full understanding of HANO's requirements with respect to employment, training, and contracting with Section 3 residents, Section 3 business concerns, Disadvantaged Business Enterprises (DBEs), and Women Business Enterprises (WBEs); and
o Agrees to act in good faith to ensure that the specified requirements relative to employment, training, and contracting are met; and
o The representations contained in the Section 3 Employment and Training Action Plan submitted with the bid/proposal are true and correct as of this date; and
o Proposes to use the services of the Section 3 business concerns, DBEs, and WBEs listed in the Contracting Action Plan; and
o Will not alter the level of employment, training, and contracting with Section 3 residents, Section 3 business concerns, DBEs, and WBEs identified in the Section 3 Employment and Training Schedule and in the Contracting Schedule without prior written notice to HANO; and
o Agrees to provide regular compliance reports to HANO, at the intervals specified by HANO and in the format specified by HANO; and
o Will monitor, ensure, and report subcontractor compliance with respect to HANO's employment and contracting requirements;
o Will provide HANO with documentation in the format and timeframe requested by HANO, such as subcontractor certifications, employee income verifications, etc. to confirm eligibility of those employees, trainees, subcontractors claiming Section 3, DBE, and/or WBE status.

\_\_\_\_\_  
Bidder's/Offeror's Name

By: \_\_\_\_\_  
Signature

\_\_\_\_\_  
Printed or Typed Name

Title: \_\_\_\_\_

Date: \_\_\_\_\_

If a corporate seal is not affixed, this document must be notarized.

Subscribed and sworn to \_\_\_\_\_ (Notary Public)
(Signature)
before me this \_\_\_\_\_ day of \_\_\_\_\_, 20\_\_\_\_

My Commission expires: \_\_\_\_\_

Date Executed: \_\_\_\_\_



**HOUSING AUTHORITY OF NEW ORLEANS**

**Contractors Section 3 Employment and Training Compliance Report**

Reporting Period: \_\_\_\_\_

**To be submitted before 5:00 p.m. on the first business day of the month**

Prime Contractor: \_\_\_\_\_ Contract No.: \_\_\_\_\_

Contract Start Date: \_\_\_\_\_ Contract Completion Date: \_\_\_\_\_

<b>Craft/Trade</b>	<b>Total Number of New Hires</b>	<b>Tier 1 Resident s Hired</b>	<b>Tier 2 Resident s Hired</b>	<b>Tier 3 Resident s Hired</b>	<b>Tier 4 Resident s Hired</b>	<b>Tier 5 (a) Resident s Hired</b>	<b>Tier 5 (b) Resident s Hired</b>	<b>Total Number of Section 3 Resident s Hired*</b>	<b>Percentage of Section 3</b>	<b>Total Number of Section 3 Resident s in Apprenticeship Programs</b>
<b>Example: Laborer</b>	6	2	1	0	0	3	0	6	100%	2

Name: \_\_\_\_\_ Title: \_\_\_\_\_

Date: \_\_\_\_\_



**HOUSING AUTHORITY OF NEW ORLEANS**

Employer Paid Training Report

To be submitted before 5:00 p.m. on the first business day of the month

Company Name: \_\_\_\_\_

Type of Training: \_\_\_\_\_

TRAININGS CLIENT ATTENDED	TRAINING PROVIDER	TRAINING DATES	# OF TRAINING HOURS	TOTAL COST OF TRAINING & TRAINING MATERIALS
1)				
2)				
3)				
4)				
5)				
6)				
7)				
8)				
9)				
10)				

Employer Name: \_\_\_\_\_

Date: \_\_\_\_\_

Title: \_\_\_\_\_

\*\* You must attach Training agenda as well as proof that your organization paid for the training such as Receipt, Copy of Check, Purchase Order, etc.\*\*



**HOUSING AUTHORITY OF NEW ORLEANS**

**Section 3 Manhour Report**

To be submitted before 5:00 p.m. on the first business day of the month

Contractor: \_\_\_\_\_ Contract No.: \_\_\_\_\_

Contract Start Date: \_\_\_\_\_ Contract Completion Date: \_\_\_\_\_

Report for month of: \_\_\_\_\_ 20\_\_\_\_\_

**Identify all Employees Including Section 3 residents who have performed work in connection with this project to date. All Section 3 employees must appear on the Certified Payroll Form (if applicable).**

Name Address, City/State Last 4 of Social Security#	Referral Source	Section 3 Category Preference	Number of Manhours Worked This Period	Hire Date	Termination Date	Total Number Man-hours

For the period of this report, indicate:

Total Number of Manhours Worked by all Employees: \_\_\_\_\_

Total Number of Manhours Worked by Section 3 Employees: \_\_\_\_\_

Total Percentage of Manhours Worked by Section 3 Employees: \_\_\_\_\_

Name: \_\_\_\_\_

Title: \_\_\_\_\_

Date: \_\_\_\_\_

**\*\* Attach Section 3 Resident Certification Forms for each new hire reported.**



**HOUSING AUTHORITY OF NEW ORLEANS**

**Contracting Compliance Report**

**To be submitted before 5:00 p.m. on the first business day of the month**

Contractor: \_\_\_\_\_ Contract No.: \_\_\_\_\_

Contract Start Date: \_\_\_\_\_ Contract Completion Date: \_\_\_\_\_

Original Contract Amount: \$ \_\_\_\_\_

Current Contract Amount (Including Change Orders): \$ \_\_\_\_\_

Report for month of: \_\_\_\_\_ 20\_\_\_\_\_

**List all Section 3/DBE/WBE Subcontractors and Suppliers utilized on this contract to date. Copies of all subcontract/supplier agreements executed during this reporting period must be submitted with report. Make copies of form if additional space is needed.**

**ALL SECTION 3/DBE/WBE CONTRACTORS ARE REQUIRED TO LIST ALL SUBCONTRACTORS**

Name of Subcontractor/Supplier	Indicate HANO Certification (DBE/WBE/ Section 3)	Scope of Work Performed	Total Subcontract Amount Including Change Orders	Amount Paid this Period	Amount Paid To Date	Balance Due

Total Amount Paid to Contractor by HANO:

This Period: \$ \_\_\_\_\_ To Date: \$ \_\_\_\_\_

Total Amount Paid by Contractor to Section 3 Business Concerns:

This Period: \$ \_\_\_\_\_ To Date: \$ \_\_\_\_\_

Total Amount Paid by Contractor to DBEs:

This Period: \$ \_\_\_\_\_ To Date: \$ \_\_\_\_\_

Total Amount Paid by Contractor to WBEs:

This Period: \$ \_\_\_\_\_ To Date: \$ \_\_\_\_\_

Name: \_\_\_\_\_

Title: \_\_\_\_\_

Date: \_\_\_\_\_





# Section 3 Employment and Training Assessment

This Assessment is designed to capture potential Section 3 Certified candidates' employment interest, work experience and training information. Information will be forwarded to employers based upon the skills required for the open positions. Applicants will be considered for positions without regard to race, color, religion, sex national origin, age or marital status.

### Personal Information

Name \_\_\_\_\_ Date \_\_\_\_\_

Address \_\_\_\_\_

City \_\_\_\_\_ State \_\_\_\_\_ Zip \_\_\_\_\_

Home Telephone \_\_\_\_\_ Alt. Telephone \_\_\_\_\_

Current Age \_\_\_\_\_ Date of Birth \_\_\_\_\_

Do you reside at a HANO affordable housing site? ( ) YES ( ) NO

If Yes, Which Site: \_\_\_\_\_ Name of Head of Household \_\_\_\_\_

Are you a HANO Housing Choice Voucher Participant ( ) YES ( ) NO

If Yes, Name of Head of Household \_\_\_\_\_

Do you reside at a federally supported housing unit? ( ) YES ( ) NO

Are you a HUD Youth Build Participant? ( ) YES ( ) NO

### Education

Highest Level of Education (Grade Completed) \_\_\_\_\_

High School Diploma \_\_\_\_\_ GED \_\_\_\_\_ Some College \_\_\_\_\_

College \_\_\_\_\_ List Degree \_\_\_\_\_ Year Completed \_\_\_\_\_

Name of last School Attend \_\_\_\_\_ City \_\_\_\_\_ State \_\_\_\_\_

Last Year Attended \_\_\_\_\_

### Employment

1. Have you ever worked before? Yes \_\_\_\_\_ No \_\_\_\_\_

2. Are you currently working? Yes \_\_\_\_\_ No \_\_\_\_\_ Full Time \_\_\_\_\_ Part Time \_\_\_\_\_

3. Current Job Title \_\_\_\_\_ Hourly Rate \_\_\_\_\_

4. Have you ever completed an occupational skills training? If so, what, when and where.

\_\_\_\_\_

5. Do you have an occupational skills credential/license? If so, what and expiration date.  
\_\_\_\_\_
6. Have you ever participated or completed work readiness training? If so, when.  
\_\_\_\_\_
7. Are there any problems or issues that may prevent you from working consistently? If so, explain.  
\_\_\_\_\_
8. What type of environment would you like to work in? \_\_\_Indoors \_\_\_Outdoors
9. What types of machinery/office equipment to you know how to operate?  
\_\_\_\_\_  
\_\_\_\_\_  
\_\_\_\_\_

**Employment History**

Name of Employer Address/ City/State	Dates of Employment Start/End	Job Title	Beginning Hourly Rate Ending Hourly Rate	Reason For Leaving

**Transportation**

1. Do you have a valid driver's license? Yes\_\_\_\_\_ No\_\_\_\_\_ State\_\_\_\_\_
2. Do you own a car or have access to reliable transportation to get to and from work?  
Yes \_\_\_\_\_ No \_\_\_\_\_ If yes, make /model/year of car.  
\_\_\_\_\_

If no vehicle or license, what is your primary means of transportation? \_\_\_\_\_

---

**References: DO NOT INCLUDE RELATIVES.**

Name \_\_\_\_\_

Address \_\_\_\_\_

City \_\_\_\_\_ State \_\_\_\_\_ Zip Code \_\_\_\_\_

Telephone \_\_\_\_\_ Position/Relationship \_\_\_\_\_

Name \_\_\_\_\_

Address \_\_\_\_\_

City \_\_\_\_\_ State \_\_\_\_\_ Zip Code \_\_\_\_\_

Telephone \_\_\_\_\_ Position/Relationship \_\_\_\_\_

Name \_\_\_\_\_

Address \_\_\_\_\_

City \_\_\_\_\_ State \_\_\_\_\_ Zip Code \_\_\_\_\_

Telephone \_\_\_\_\_ Position/Relationship \_\_\_\_\_

Signature: \_\_\_\_\_ Date: \_\_\_\_\_

Print Name: \_\_\_\_\_

## **SKILLS ASSESSMENT**

- I. Place an (X) on the area(s) in which you have skills and list the number of years of experience.

<b>Trade</b>	<b># Of Years Experience</b>	<b>Trade</b>	<b># Of Years Experience</b>
<b><i>Carpentry</i></b>		<b><i>Drywall</i></b>	
Form Carpentry		Painting	
Cement Forms Finisher		Drywall Hanger	
Rough Frame Carpentry		Drywall Finisher	
Finish Carpentry			
Finish Interior Carpenter		<b><i>Flooring</i></b>	
Finish Exterior		Carpet Installation	
Door Installation		Tile Setting	
Window Installation		Wood Flooring Installation	
<b><i>Machine Operation</i></b>		<b><i>Misc. Items</i></b>	
Forklift		Appliance Installation	
Boom/lift		Fencing	
Bob Cat		Landscaping	
Back Hoe		Plumbing	
Excavator		Plumbing Fixture Install	
Sweeper		Janitorial	
		HVAC	
<b><i>Electrical</i></b>		Security	
Electrical (wiring)		General Labor	
Electrical (Connection)		Other 1	
Electrical (Fixture Install)		Other 2	
		Other 3	
<b><i>Concrete / Masonry</i></b>		Other 4	
Cement			
Steel Setter			
<b>Business</b>	<b># Of Years Experience</b>	<b>List any Other Field</b>	<b># Of Years Experience</b>
Administrative Assistant			
Accountant			
Architect			
Engineer			
Social Service			
File Clerk			
Legal Aid Assistant			
Receptionist			
Mail Clerks			
Clerical Assistant			
Customer Service Rep			
Project Assistant			

I. Please place an (X) by the area(s) in which you are interested in training.

<input type="checkbox"/>	Carpentry	<input type="checkbox"/>	Electrical	<input type="checkbox"/>	Painting
<input type="checkbox"/>	Carpet Installation	<input type="checkbox"/>	Cement / Masonry	<input type="checkbox"/>	Fencing
<input type="checkbox"/>	Drywall	<input type="checkbox"/>	Landscaping	<input type="checkbox"/>	Plumbing
<input type="checkbox"/>	Tile Setting	<input type="checkbox"/>	Wood Flooring installation	<input type="checkbox"/>	Iron Work
<input type="checkbox"/>	Machine Operation	<input type="checkbox"/>	HVAC	<input type="checkbox"/>	Appliance Installation
<input type="checkbox"/>	Bricklaying	<input type="checkbox"/>	Janitorial	<input type="checkbox"/>	General labor
<input type="checkbox"/>	Security	<input type="checkbox"/>	Window Installation	<input type="checkbox"/>	Door Installation
<input type="checkbox"/>	Fixtures Installation	<input type="checkbox"/>	Other	<input type="checkbox"/>	

<input type="checkbox"/>	HAZMAT	<input type="checkbox"/>	LIST OTHERS	<input type="checkbox"/>	
<input type="checkbox"/>	HAZWOPER	<input type="checkbox"/>		<input type="checkbox"/>	
<input type="checkbox"/>	Truck Driving	<input type="checkbox"/>		<input type="checkbox"/>	
<input type="checkbox"/>	OSHA	<input type="checkbox"/>		<input type="checkbox"/>	
<input type="checkbox"/>	Pipe laying	<input type="checkbox"/>		<input type="checkbox"/>	
<input type="checkbox"/>	Green Construction	<input type="checkbox"/>		<input type="checkbox"/>	
<input type="checkbox"/>		<input type="checkbox"/>		<input type="checkbox"/>	
<input type="checkbox"/>		<input type="checkbox"/>		<input type="checkbox"/>	

II. Comments



# Attachment Q

# Statement of Bidder's

# Qualifications



**HOUSING AUTHORITY OF NEW ORLEANS  
PROCUREMENT AND CONTRACTS DEPARTMENT**

**INVITATION FOR BIDS #25-911-01 STATEMENT OF BIDDER'S**

**QUALIFICATIONS**

This form must be submitted with each bid or proposal. Each business of a joint venture must submit this form. Complete all blanks by entering the requested information or "NA" if it is not applicable to your business.

<b>BUSINESS NAME:</b>		
<b>AVG. ANNUAL SALES (LAST THREE (3) YEARS):</b>	<b>CURRENT NET WORTH:</b>	<b>DATE BUSINESS STARTED:</b>
<b>PARENT COMPANY (IF AFFILIATE):</b>		<b>PREVIOUS BUSINESS NAME:</b>

**OFFICERS, OWNERS, OR PARTNERS**

NAME	OFFICIAL CAPACITY

**PERSONS AUTHORIZED TO SIGN OFFERS AND CONTRACTS IN COMPANY NAME**

NAME	OFFICIAL CAPACITY

**BANK REFERENCE**

<b>BANK NAME:</b>	<b>ADDRESS:</b>
<b>CONTACT PERSON:</b>	<b>TELEPHONE NO.:</b>

**STATEMENT OF BIDDER'S QUALIFICATIONS (CONT.)**

**QUALITY ASSURANCE**

	YES	NO
A. Has the Bidder has successfully completed three similar projects within the past five years?		
B. Over the past five years, has the Bidder completed all of their projects within the contract time frame and budget?		
C. Over the past five years, has the Bidder ever been Terminated for Default by any public entity?		
D. Over the past five years, has the Bidder ever been issued a finding of non-compliance by HANO relative to DBE, WBE and Section 3 Employment and Contracting?		
E. Over the past five years, has the Bidder ever been issued a finding of non-compliance relative to Davis Bacon Wage Requirements?		

**BUSINESS REFERENCES (Provide three existing or completed work activities by your business which are similar to or support your ability to successfully complete the scope of work.) Please attach additional pages if additional space is needed.**

AGENCY/COMPANY NAME:	ACTIVITY:	DOLLAR AMOUNT:
DATE COMPLETED:	CONTACT PERSON:	TELEPHONE NO.:
AGENCY/COMPANY NAME:	ACTIVITY:	DOLLAR AMOUNT:
DATE COMPLETED:	CONTACT PERSON:	TELEPHONE NO.:
AGENCY/COMPANY NAME:	ACTIVITY:	DOLLAR AMOUNT:
DATE COMPLETED:	CONTACT PERSON:	TELEPHONE NO.:

**The undersigned covenants and agrees to provide the Housing Authority of New Orleans current, complete, and accurate information regarding their business' status. The undersigned further agrees to permit examination of books, records, and files by authorized representatives of the Housing Authority of New Orleans or the U.S. Department of Housing and Urban Development. Any material misrepresentation may be grounds for terminating any contract which may be awarded and for initiating action under federal or state laws concerning false statements.**

SIGNATURE OF PRINCIPAL:	PRINTED NAME OF PRINCIPAL:	DATE SIGNED:
-------------------------	----------------------------	--------------

# Attachment R

# Corporate Resolution

(Bidder may use this form or their own corporate resolution)

This is a requirement document



CORPORATE RESOLUTION

I, \_\_\_\_\_, the undersigned Secretary of \_\_\_\_\_ (The "Corporation") hereby certifies that: The Corporation is duly organized and existing under the laws of the State of \_\_\_\_\_ and the following is true, accurate and complete transcript of a resolution contained in the minute book of the Board of Directors of said Corporation duly held on the \_\_\_\_\_ day of \_\_\_\_\_, \_\_\_\_\_ at which meeting there was present and acting throughout a quorum authorized to transact business hereinafter described, and that the proceedings of said meeting were in accordance with the charter and by-laws of said Corporation and that said resolutions have not been amended or revoked and are in full force and effect:

Resolved, that \_\_\_\_\_ (name), \_\_\_\_\_ (title) of the Corporation, be and is hereby authorized and empowered to sign any and all documents on behalf of said Corporation, and to take such steps, and do such other acts and things, as in his or her judgment may be necessary, appropriate or desirable in connection with any proposal submitted to, or any contract entered into with the City of Austin: and,

Resolved, that any and all transactions by and of the officers or representatives of the Corporation, in its name and for its account, with the City of Austin prior to the adoption of these resolutions be, and they are hereby, ratified and approved for all purposes.

Witness my hand and seal of the Corporation this \_\_\_\_ day of \_\_\_\_\_, 202\_.

\_\_\_\_\_  
Secretary-Treasurer

(Corporate Seal)