



INVITATION FOR BIDS

FOR

WATER SOFTENER SYSTEM FOR GUSTE

HIGH RISE

IFB No. 23-912-41

SUBMISSION DATE: MONDAY, AUGUST 14, 2023

2:00 P.M. CST

PREPARED BY:

**Housing Authority of New Orleans
Procurement and Contracts Department
4100 Touro Street
New Orleans, LA 70122**

ISSUED Friday, July 14, 2023

Table of Contents

[Table No. 1]

Section	Description	Page
1.0	The Agency's Reservation of Rights	3
2.0	Scope of Work	4
2.1	General Requirements (See Appendix A for Technical Specifications)	4
3.0	Bid Requirements	5
3.1	Bid Submittals	5
3.2	Entry of Proposed Fees	5
3.3	Additional Information pertaining to the preceding listed Pricing Items	7
3.4	Submission Responsibilities	8
3.5	Bidder's Responsibilities – Contact with the Agency	9
3.6	Bidder's Responsibilities – Equal Employment Opportunity and Supplier Diversity	9
3.7	Pre-bid Conference	11
3.8	Recap of Attachments	11
3.9	Bid Results	12
4.0	Contract Award	13
4.1	Contract Award Procedure	13
4.2	Contract Conditions	13
4.3	Contract Period	14
4.4	Licensing and Insurance Requirements	14
4.5	Contract Service Standards	15
4.6	Prompt Return of Contract Documents	15
5.0	Index of Tables	15
6.0	Appendix A through B (Technical Specifications and Drawings)	16
7.0	Referenced Attachments	53

INVITATION FOR BIDS (IFB) No. 23-912-41 Water Softener System for Guste High Rise

IFB INFORMATION AT A GLANCE

[Table No. 2]

AGENCY CONTACT PERSON	Thelma Bowers, Contract Administrator Telephone: (504) 670-3448 E-mail: tbowers@hano.org
HOW TO OBTAIN THE IFB DOCUMENTS ON HANO'S WEBSITE	<ol style="list-style-type: none"> 1. Access www.hano.org. 2. Click on the "Business" tab on the blue taskbar. 3. Click on "Active Solicitations" and go to the specific solicitation. 4. If you have any problems accessing the IFB documents, please contact Procurement at procurement@hano.org.
PRE-BID CONFERENCE/SITE VISIT	Wednesday, July 19, 2023 10:30 a.m. Meeting ID: 899 9344 7438 Passcode: 630545
QUESTION SUBMITTAL DEADLINE	Monday, July 31, 2023
HOW TO FULLY RESPOND TO THIS IFB BY SUBMITTING A BID SUBMITTAL	<ol style="list-style-type: none"> 1. As directed within Section 3.2.1 of the IFB document, submit proposed pricing, where provided for, within the IFB. 2. As instructed within Section 3.0 of the IFB document, deliver three (3) complete sets (one (1) original clearly marked or stamped "original" and two (2) copies) of the required submittals in a sealed envelope clearly marked with the words "BID Documents" to HANO's Procurement and Contracts Department (address below).
BID SUBMITAL RETURN & DEADLINE	*Monday, August 14, 2023 at 2:00 p.m Housing Authority of New Orleans Procurement and Contracts Department 4100 Touro Street, New Orleans, LA 70122

1.0 THE AGENCY'S RESERVATION OF RIGHTS. The Agency reserves the right to:

- 1.1 Right to Reject, Waive, or Terminate the IFB.** Reject any or all bids, to waive any informality in the IFB process, or to terminate the IFB process at any time, if deemed by the Agency to be in its best interests.
- 1.2 Right to Not Award.** Not to award a contract pursuant to this IFB.
- 1.3 Right to Terminate.** Terminate a contract awarded pursuant to this IFB, at any time for its convenience upon 10 days written notice to the successful bidder(s).

- 1.4 **Right to Determine Time and Location.** Determine the days, hours, and locations that the successful bidder(s) shall provide the services called for in this IFB.
- 1.5 **Right to Retain Bids.** Retain all bids submitted and not permit withdrawal after bid opening and without the written consent of HANO's Contracting Officer (CO).
- 1.6 **Right to Negotiate.** Negotiate with the apparent, low bidder
- 1.7 **Right to Reject Any Bid.** Reject and not consider any bid that does not meet the requirements of this IFB, including but not necessarily limited to incomplete bids and/or bids offering alternate or non-requested services.
- 1.8 **No Obligation to Compensate.** Have no obligation to compensate any bidder for any costs incurred in responding to this IFB.
- 1.9 **Right to Prohibit.** At any time during the IFB or contract process to prohibit any further participation by a bidder or reject any bid submitted that does not conform to any of the requirements detailed herein.
- 1.10 **Right to Reject - Obtaining Competitive Solicitation Documents.** HANO's website and Procurement Staff are the only official and appropriate means to obtain the IFB documents (and any other information pertaining to this IFB such as addenda). Accordingly, by submitting a response to this IFB the respondent thereby affirms that he/she obtained all information on the website.

2.0 SCOPE OF WORK

HANO is seeking sealed bids from Contractors for removal and replacement of the water softener system at Guste High Rise (1301 Simon Bolivar Ave., New Orleans, La 70125).

- A. Contractor to remove existing water softener units as indicated in the documents. Removal shall be in such a manner as to prep items to remain for future connection to new unit.
- B. Contractor to install new water softener unit specified at the location indicated in the documents.
- C. Contractor shall follow installation sequencing as indicated in the documents. All procedures required to perform the removal and installation of the new boiler units shall be followed for each installation. (Additional Specifications and Drawings in Appendix A& B)

2.1 GENERAL REQUIREMENTS:

- A. The Contractor shall furnish all labor, materials, equipment tools, service, and incidentals to complete all work required by these specifications and as shown on the drawings and as directed by the engineer/architect.
- B. The Contractor shall perform the work and make ready for use of the building. If any damages to existing equipment or the building are made during construction, contractor will rectify at his own cost.

INVITATION FOR BIDS (IFB) No. 23-912-41 Water Softener System for Guste High Rise

- C. Furnish and install all materials, equipment, and labor which is reasonably and properly inferable and necessary for the proper completion of the work, whether specially indicated in the Contract documents or not.
- D. Protect all existing building components and contents from damage. It is intended that any existing building components and contents in place shall be repaired to original condition if damaged by work of this Contract.
- E. Contractor shall verify all field and project conditions prior to preparing his bid. Any conditions not described in these drawings and specifications shall be brought to the attention of the A/E ten (10) days prior to bid date. Failure to do so shall render the contractor responsible for correction of this condition should he be awarded the contract.
- F. The work "provide" as used in these specifications and on the drawings will be termed to mean "furnish and install".
- G. Visit and examine the project site with all authorities concerned in order to become familiar with all existing conditions pertinent to the work to be performed thereon. No additional compensation will be allowed for failure to be so informed.
- H. All work shall be performed in a neat and workmanlike manner and in accordance with all codes, standards, and requirements of the industry.
- I. Check all specifications and all drawings and bring to the attention of the A/E any conflicts or variations as shown or noted.
- J. Specifications and accompanying drawings apply to all material and / or labor for construction of work specified herein and shown on drawings.
- K. The Contractor shall pay for all taxes, license, and permits required for execution of the work. Note: This is a sales tax-exempt project. Refer to the documents in the Bid Package.
- L. For any points which are not clear, or from items and/or details which the Contractor feels are in need of clarification, provide request of clarifications in writing to HANO's Procurement Department.
- M. The drawings and the specifications are complementary and what is shown and/or called for shall be furnished and installed the same as if shown and/or called for in the other.
- N. In case of discrepancies and/or ambiguities in the drawings and/or in the specifications, submit requests for clarifications in writing to HANO's Procurement Department. Failure to do so on the part of the successful bidder shall be construed as explicit agreement on his part to abide by the A/E's decision in such matters.

This work is for the Owner, HANO, Housing Authority of New Orleans.
Contact Langston Ford, Construction Manager, for site visits 504-915-4870

3.0 BID SUBMITTALS.

[Table No. 3]

(1) IFB Section	(3) Description
3.1.1	Form of Bid. This Form must be fully completed, executed where provided thereon and submitted as a part of the bid submittal.

INVITATION FOR BIDS (IFB) No. 23-912-41 Water Softener System for Guste High Rise

3.1.2	Form HUD 5369-A (8/93), <i>Certifications and Representations of Bidders, Construction Contract</i> . This Form is attached hereto as Attachment B to this IFB document. This form must be fully completed, executed where provided thereon and submitted under this tab as a part of the bid submittal. Attachment E
3.1.2.1	Form HUD SF-LLL Disclosure of Lobbying Activities. This Form is attached hereto as Attachment B-1 to this RFP document. This form must be fully completed, executed where provided thereon and submitted under this tab as a part of the proposal submittal.
3.1.2.2	Form HUD-50071 Certification of Payments to Influence Federal Transactions This Form is attached hereto as Attachment B-2 to this RFP document. This form must be fully completed, executed where provided thereon and submitted under this tab as a part of the proposal submittal.
3.1.2.3	Form HUD-50070 Certification for a Drug-Free Workplace This Form is attached hereto as Attachment B-3 to this RFP document. This form must be fully completed, executed where provided thereon and submitted under this tab as a part of the proposal submittal.
3.1.3	Profile of Firm Form. The Profile of Firm Form is attached hereto as Attachment C to this IFB document. This 2-page Form must be fully completed, executed, and submitted as a part of the bid submittal.
3.1.4	Equal Employment Opportunity/Supplier Diversity. The bidder must submit a copy of its Equal Opportunity Employment Policy and a complete description of the positive steps it will take to ensure compliance, to the greatest extent feasible, with the regulations detailed within the following Section 3.6 herein pertaining to supplier diversity (i.e., small, minority-, and women-owned businesses).
3.1.5	Acknowledgement of Addenda. Please check HANO's website under "Business" and "Active Solicitations" to confirm that you have read and acknowledged in writing all addenda issued and submit your acknowledgment of each addendum on Attachment H.
3.1.6	Entry of Proposed Fees, Louisiana Uniform Public Work Bid Form This bidder must submit their proposed fees on this form. The total base bid is inclusive of all fees associated with this project. Attachment I.
3.1.7	Certification of Contractor Non-Exclusion Attachment J
3.1.8	Subcontractor/Joint Venture Information. The bidder shall identify whether or not he/she intends to use any subcontractors for this job, if awarded, and/or if the bid is a joint venture with another firm. Please remember that all information required from the bidder under the preceding submittals must also be included

INVITATION FOR BIDS (IFB) No. 23-912-41 Water Softener System for Guste High Rise

	for any major subcontractors (10% or more) or from any joint venture.
3.1.10	Vendor Registration Form Attachment L
3.1.11	Bid Bond. All bids must be accompanied by a bid guarantee at the time of submission, which shall be in the form of a certified check, cashier's check, or bid bond for not less than five percent of the contract price of work to be done, as evidence of good faith of the bidder. (REQUIRED) Attachment M
3.1.12	Statement of Bidder's Qualifications. This form must be submitted as a contributor to determining whether the bidder is responsible. Attachment P
3.1.13	Corporate Resolution. This form or a similar form must be submitted authorizing the signature of the bidder on behalf of the business. Attachment R

3.2 Entry of Proposed Fees.

3.2.1 *A lump sum fee shall be submitted on the Louisiana Uniform Public Work Bid Form only (Attachment I). This form must bear an original signature. Do not refer to any of your fees or costs on other submittals.*

3.2.2 Pricing Items. The base bid is all-inclusive of the lump sum work for all related costs that the successful bidder will incur to provide the noted goods and services, including, but not limited to employee wages and benefits; clerical support; overhead; profit; licensing; insurance; materials; supplies; tools; equipment; long distance telephone calls; travel expenses; document copying not specifically agreed to by the Agency; etc.

Bidders shall visit the project site prior to submitting a bid to familiarize themselves with the project. By submitting a bid, bidders acknowledge that they have visited the project site and are completely familiar with existing conditions and the full Scope of Work. Failure to properly assess the full Scope of Work will not be cause for an increase in the Contract Price and/or Time.

[Table No. 4]

(1) IFB Section	(2) Designation:	(3) Total Cost:
Appendix A & B	Lump Sum Cost for Removal and Replacement of Water Softener System for Guste High Rise	
Total Base Bid		\$

3.3 Additional Information pertaining to the preceding listed Pricing Items.

- 3.3.1 Manufacturer/Brand Names.** Wherever HANO specifies the name of a certain brand, make, manufacturer, or uses a definite specification, they are used only to denote the quality standard of product desired, and they do not restrict bidders to the specific brand, make, manufacturer, or specification named. They are used only to set forth and convey to prospective bidders the general style, type, character, and quality of product desired. Equivalent products may be acceptable.
- 3.3.2 Price Escalation.** Pertaining to the ensuing contract, there shall be no escalation of the proposed unit costs allowed at any time during the awarded contract.
- 3.3.3 Prior Approval Required.** Please note that the successful bidder shall NOT conduct any additional work without the prior written authorization of the Agency representative (which will occur, at the Agency's discretion, via delivery of a Notice to Proceed and/or a signed Change Order, which may take the form of an e-mail). Failure to abide by this directive shall release the Agency of any obligation to pay the successful bidder for any work conducted without the noted prior written authorization.
- 3.3.4 No Deposit/No Retainer.** The Agency will NOT pay any retainer fees as a result of award of the ensuing contract. This means that the Agency will pay the successful bidder for actual work performed only and pertaining to the fixed fee Pricing Item.
- 3.4 Bid Submission.** All submittals must be submitted in a sealed enclosure and all bids must be submitted and time-stamped received in the designated Agency office by no later than submittal deadline stated herein (or within any ensuing addendum). A total of 1 original signature copy (marked "ORIGINAL") and 2 copies of the "hard copy" bid submittal, shall be placed in a sealed package, and addressed to:

**Housing Authority of New Orleans
Procurement and Contracts Department
Attn: Bejide Legania, Procurement Manager
4100 Touro Street
New Orleans, Louisiana 70122**

- 3.4.1 Exterior of Submittal Package.** The package exterior must clearly denote the above noted IFB number and must have the bidder's name, return address, state of Louisiana Contractor's License number and date and time bids are due. Bids received after the published deadline will not be accepted.
- 3.4.2 Submission Conditions.** DO NOT FOLD OR MAKE ANY ADDITIONAL MARKS, NOTATIONS OR REQUIREMENTS ON THE DOCUMENTS TO BE SUBMITTED! Bidders are not allowed to change any requirements or forms contained herein, either by making or entering onto these documents or the documents submitted any revisions or additions; and if any such additional marks, notations or requirements are entered on any of the documents that are submitted to the Agency by the bidder, such may invalidate that bid. If, after

accepting such a bid, the Agency decides that any such entry has not changed the intent of the bid that the Agency intended to receive, the Agency may accept the bid and the bid shall be considered by the Agency as if those additional marks, notations or requirements were not entered on such. By accessing and downloading these documents, each prospective bidder that does so is thereby agreeing to confirm all notices that the Agency delivers to him/her as instructed, and by submitting a bid, the bidder is thereby agreeing to abide by all terms and conditions published herein and by addendum pertaining to this IFB.

3.4.3 Submission Responsibilities. It shall be the responsibility of each bidder to be aware of and to abide by all dates, times, conditions, requirements and specifications set forth within all applicable documents issued by the Agency, including the IFB document, the documents listed within the following Section 3.8 herein, and any addenda and required attachments submitted by the bidder. By virtue of completing, signing, and submitting the completed documents, the bidder is stating his/her agreement to comply with all conditions and requirements set forth within those documents. Written notice from the bidder not authorized in writing from HANO to exclude any of the Agency requirements contained within the documents may cause that bidder to not be considered for award.

3.5 Bidder's Responsibilities – Contact with the Agency. It is the responsibility of the bidder to address all communication and correspondence pertaining to this IFB process to the Procurement staff only. Bidders must not make inquiry or communicate with any other Agency staff member or official (including members of the Board of Commissioners pertaining to this IFB. Failure to abide by this requirement may be cause for the Agency to not consider a bid submittal received from any bidder who may not have abided by this directive.

3.5.1 Addenda. All questions and requests for information must be addressed in writing to **Thelma Bowers, Contract Administrator, at tbowers@hano.org**. Procurement will respond to all such inquiries in writing by addendum to all prospective bidders (i.e., firms or individuals that have obtained the IFB Documents). Bidders must provide written acknowledgement of addenda with their submissions.

3.6 Bidder's Responsibilities – Equal Employment Opportunity and Supplier Diversity. Both the Contractor and the Agency have, pursuant to HUD regulation, certain responsibilities pertaining to the hiring and retention of personnel and subcontractors.

3.6.1 Within 2 CFR §200.321 it states:

3.6.1.1 Contracting with small and minority businesses, women's business enterprises, and labor surplus area firms.

3.6.1.2 (a) The non-Federal entity must take all necessary affirmative steps to assure that minority businesses, women's business enterprises, and

labor surplus area firms are used when possible.

3.6.1.3 (2) Affirmative steps must include:

3.6.1.3.1 (1) Placing qualified small and minority businesses and women's business enterprises on solicitation lists;

3.6.1.3.2 (2) Assuring that small and minority businesses, and women's business enterprises are solicited whenever they are potential sources;

3.6.1.3.3 (3) Dividing total requirements, when economically feasible, into smaller tasks or quantities to permit maximum participation by small and minority business, and women's business enterprises;

3.6.1.3.4 (4) Establishing delivery schedules, where the requirement permits, which encourage participation by small and minority business, and women's business enterprises;

3.6.1.3.5 (5) Using the services and assistance, as appropriate, of such organizations as the Small Business Administration and the Minority Business Development Agency of the Department of Commerce; and

3.6.1.3.6 (6) Requiring the prime contractor, if subcontracts are to be let, to take the affirmative steps listed in paragraphs (1) through (5) of this section.

3.6.2 Within HUD Procurement Handbook 7460.8 REV 2 it states:

3.6.2.1 Section 15.5.A, Required Efforts. Consistent with Presidential Orders 11625, 12138, and 12432, the <Agency> shall make every effort to ensure that small businesses, MBEs, WBEs, and labor surplus area businesses participate in <Agency> contracting.

3.6.2.2 Section 15.5.B, Goals. <The Agency> is encouraged to establish goals by which they can measure the effectiveness of their efforts in implementing programs in support of . . . contracting with disadvantaged firms. It is important to ensure that the means used to establish these goals do not have the effect of limiting competition and should not be used as mandatory set-aside or quota, except as may otherwise be expressly authorized in regulation or statute. Some localities have adopted minority contracting set-aside policies or geographic limitations, which may be in conflict with Federal

INVITATION FOR BIDS (IFB) No. 23-912-41 Water Softener System for Guste High Rise

requirements for full and open competition.

3.6.3 Within HANO’s Procurement Policy it states that our Agency will:

3.6.3.1 Assistance to Small and Other Business, Required Efforts:

3.6.3.1.1 Including such firms, when qualified, on solicitation mailing lists;

3.6.3.1.2 Encouraging their participation through direct solicitation of bids or bids whenever they are potential sources;

3.6.3.1.3 Dividing total requirements, when economically feasible, into smaller tasks or quantities to permit maximum participation by such firms;

3.6.3.1.4 Establishing delivery schedules, where the requirement permits, which encourage participation by such firms;

3.6.3.1.5 Using the services and assistance of the Small Business Administration, and the Minority Business Development Agency of the Department of Commerce; and,

3.6.3.1.6 Requiring prime contractors, when subcontracting is anticipated, to take the positive steps listed above.

3.6.4 Requirements. Accordingly, please see HANO’S Employment, Training, and Contracting Policy attached which details the information pertaining to this issue that the bidder must submit in response to this bid showing compliance, to the greatest extent feasible, with these regulations.

3.7 Pre-bid Conference. A pre-bid conference is scheduled for Wednesday, July 19, 2023, at 10:30 a.m. via Zoom (Meeting ID: 899 9344 7438; Passcode: 630545). A site visit at the Guste High Rise will immediately follow the pre-bid conference.

3.8 Recap of Attachments. It is the responsibility of each bidder to verify that he/she has received the following attachments pertaining to this IFB, which are included as a part of this IFB:

[Table No. 5]

(1) IFB Section	(2) Document No.	(3) Attachment	(4) Description
3.8.1	1.0		This IFB Document
3.8.2	2.0		“No-Bid” Response Form

INVITATION FOR BIDS (IFB) No. 23-912-41 Water Softener System for Guste High Rise

3.8.3	3.0	A	Form of Bid
3.8.4	4.0	B	Form HUD-5369 (10/2002), <i>Instructions to Bidders for Construction Contracts Public and Indian Housing</i>
3.8.5	5.0	B-1	Form SF-LLL <i>Disclosure of Lobbying Activities</i>
3.8.6	6.0	B-2	Form HUD-50071 (01/14), <i>Certification of Payments to Influence Federal Transactions</i>
3.8.7	7.0	B-3	Form HUD-50070 (01/14), <i>Certification for a Drug-Free Workplace</i>
3.8.8	8.0	C	Profile of Firm Form
3.8.9	9.0	D	Section 3 Business Preference Form
3.8.10	10.0	E	Form HUD-5369-A (11/92), <i>Representations, Certifications, and Other Statements of Bidders</i>
3.8.11	11.0	F	<i>Supplemental Conditions for Bidders & Contractors (SIPC)</i>
3.8.12	12.0	G	HUD-5370 (01/2014), <i>General Conditions for Construction Contracts</i>
3.8.13	13.0	H	Acknowledgement of Addenda
3.8.14	14.0	I	Entry of Proposed Fees, <i>Louisiana Uniform Public Work Bid Form</i>
3.8.15	15.0	J	Certification of Contractor Non-Exclusion
3.8.16	16.0	K	E-Verification Affidavit (Only required to be submitted post-bid by the awarded bidder)
3.8.17	17.0	L	Vendor Registration Form
3.8.18	18.0	M	Bid Bond Sample Form
3.8.19	19.0	N	Performance Bond Sample Form (Only required post-bid by the awarded bidder)
3.8.20	20.0	O	Davis Bacon Wage Rates
3.8.21	21.0	P	Employment, Training and Contracting Policy
3.8.22	22.0	Q	Statement of Bidder's Qualifications
3.8.23	23.0	R	Corporate Resolution

3.9 BID RESULTS.

3.9.1 Notice of Bid Award. If an award is completed, all bidders will receive by e-mail either a Notice of Award or Notice of Regrets. Such notice shall inform all bidders of:

- 3.9.1.2 Which bidder received the award;
- 3.9.1.3 Where each bidder placed in the process as a result of the evaluation of the bids received;
- 3.9.1.4 The cost or financial offers received from each bidder;
- 3.9.1.5 Each bidder's right to a debriefing and to protest.

3.9.2 Restrictions. All persons having familial (including in-laws) and/or employment relationships (past or current) with principals and/or employees of a bidder entity will be excluded from participation on the Agency evaluation committee. Similarly, all persons having ownership interest in and/or contract with a bidder entity will be excluded from participation on the Agency evaluation committee.

4.0 CONTRACT AWARD.

4.1 Contract Award Procedure. If a contract is awarded pursuant to this IFB, the following detailed procedures will be followed:

4.1.1 By completing, executing and submitting a bid, the "bidder is thereby agreeing to abide by all terms and conditions pertaining to this IFB as issued by the Agency," including the contract clauses already attached in Attachment G. Accordingly, the Agency has no responsibility to conduct after the submittal deadline any negotiations pertaining to the contract clauses already published.

4.2 Contract Conditions. The following provisions are considered mandatory conditions of any contract award made by HANO pursuant to this IFB:

4.2.1 Contract Form. The Agency will not execute a contract on the Contractor's form — contracts will only be executed on the Agency's form (please see standard contract clauses on Attachment F and G each attached hereto), and by submitting a bid the Contractor agrees to do so (please note that HANO reserves the right to amend this form as the Agency deems necessary). However, the Agency will during the IFB process (prior to the posted question deadline) consider any contract clauses that the bidder wishes to include therein and submits in writing a request for the Agency to do so; but the failure of the Agency to include such clauses does not give the Contractor the right to refuse to execute the Agency's contract form. It is the responsibility of each prospective bidder to notify the Agency, in writing, prior to submitting a bid, of any contract clause that he/she is not willing to include in the final executed contract and abide by. The Agency will consider and respond to such written correspondence, and if the prospective bidder is not willing to abide by the Agency's response (decision), then that prospective bidder shall be deemed ineligible to submit a bid.

4.2.1.1 Mandatory HUD Forms. Please note that HANO has no legal right or ability to (and will not) at any time negotiate any clauses contained

within ANY of the HUD forms included as a part of this IFB.

4.2.1.2 E-Verify Affidavit. The Contractor must certify compliance with Louisiana's E-Verify requirements, in that the Contractor is registered, uses, and will continue to use the E-Verify, Federal Work Authorization Program throughout the contract period. This Form is attached hereto as Attachment G-4 to this IFB document. This 1-page Form will be fully completed and executed where provided thereon by the successful bidder and will be a part of the ensuing contract (NOTE: It is NOT necessary to complete and submit this form as a part of the bid submittal – only the awarded bidder(s) will be required to do so as a part of the contract execution).

4.2.2 Assignment of Personnel. HANO shall retain the right to demand and receive a change in personnel assigned to the work if HANO believes that such change is in the best interest of HANO and the completion of the contracted work.

4.2.3 Unauthorized Subcontracting Prohibited. The Contractor shall not assign any right, nor delegate any duty for the work proposed pursuant to this IFB (including, but not limited to, selling or transferring the contract) without the prior written consent of HANO. Any purported assignment of interest or delegation of duty, without the prior written consent of HANO shall be void and may result in the cancellation of the contract with the Agency, or may result in the full or partial forfeiture of funds paid to the Contractor as a result of the proposed contract; as determined by HANO.

4.3 Time of Completion. The Contractor shall commence work under this contract at the time stipulated in the written "Notice to Proceed" (NTP) issued by the local authority. The Contractor shall complete the work in 90 calendar days. The work shall be considered complete only when the Local Authority has issued its formal "Certificate of Acceptance".

4.4 Licensing and Insurance Requirements. Prior to award (but not as a part of the bid submission) the *Contractor* will be required to provide:

4.4.1 The project shall be awarded only to contractors who are licensed under State of Louisiana Contractors License Law La. R.S. 37:2150-2192 with a major classification in Mechanical Construction.

4.4.2 Workers Compensation Insurance. An original certificate evidencing the bidder's current industrial (worker's compensation) insurance carrier and coverage amount not less than \$100,000.00 (NOTE: Workers Compensation Insurance will be required of any Contractor that has employees other than just the owner working on-site to provide the services);

4.4.3 General Liability Insurance. An original certificate evidencing General Liability coverage, naming HANO as an additional insured, together with the appropriate

INVITATION FOR BIDS (IFB) No. 23-912-41 Water Softener System for Guste High Rise

endorsement to said policy reflecting the addition of HANO as an additional insured under said policy (minimum of \$1,000,000 each occurrence, general aggregate minimum limit of \$1,000,000, together with damage to premises and fire damage of \$50,000 and medical expenses any one person of \$5,000), with a commercially reasonable deductible (i.e., “commercially reasonable,” meaning at least 1% of the “general aggregate minimum” of the policy, with a maximum deductible amount of \$50,000); **Automobile Insurance.** An original certificate showing the bidder’s automobile insurance coverage in a combined single limit of \$500,000. For every vehicle utilized during the term of this program, when not owned by the entity, each vehicle must have evidence of automobile insurance coverage with limits of no less than \$100,000/\$300,000 and medical pay of \$5,000.

4.4.4 City/Parish/State Business License. If applicable, a copy of the bidder’s business license allowing that entity to provide such services within the City of New Orleans, Orleans Parish, and/or the State of Louisiana.

4.4.5 Certificates/Profile of Firm Form. Pertaining to the aforementioned (within Sections 5.4.1 through 5.4.5) insurance certificates and licenses, each bidder is required to enter related information where provided for on the Profile of Firm Form (do not attach or submit copies of the insurance certificates or licenses within the bid submittal – we will garner the necessary documents from the successful bidder prior to contract execution).

4.5 Contract Service Standards. All work performed pursuant to this IFB must conform and comply with all applicable local, state and federal codes, statutes, laws, and regulations.

4.5 Prompt Return of Contract Documents. Any and all documents required to complete the contract, including contract signature by the successful bidders, shall be provided to the Agency within 10 workdays of notification by the Agency.

Index of Tables

[Table No. 8]

Table	Description	Page
1	Table of Contents	2
2	IFB Information at a Glance	3
4	Pricing Items	7
5	Recap of Attachments	11
8	Index of Tables	15

Appendix A Technical Specifications



TABLE OF CONTENTS

<u>SECTION</u>	<u>PAGE NUMBER</u>
 <u>DIVISION 0 – BID DOCUMENTS</u>	
FRONT END DOCUMENTS	
 <u>DIVISION 1 – GENERAL REQUIREMENTS</u>	
01010 - SUMMARY OF WORK.....	3 pages
01045 - CUTTING AND PATCHING.....	3 pages
01300 – SUBMITTALS.....	4 pages
01370 – SCHEDULE OF VALUES.....	1 page
01600 – MATERIALS AND EQUIPMENT.....	4 pages
01700 – PROJECT CLOSEOUT.....	8 pages
 <u>TECHNICAL SPECIFICATIONS</u>	
223100 – DOMESTIC WATER SOFTNER	7 pages

SECTION 01010

SUMMARY OF WORK

PART 1 – GENERAL

1.1 RELATED DOCUMENTS

- A. Drawings and general provisions of the contract, including General and Supplementary Conditions and Divisions 1 Specifications Section, apply to the work of this Section.

1.2 SCOPE OF WORK

THE BASE BID

- A. Contractor to remove existing water softner units as indicated in the documents. Removal shall be in such a manner as to prep items to remain for future connection to new unit.
- B. Contractor to install new water softner unit specified at the location indicated in the documents.
- C. Contractor shall follow installation sequencing as indicated in the documents. All procedures required to perform the removal and installation of the new boiler units shall be followed for each installation.

1.3 GENERAL

- A. The Contractor shall furnish all labor, materials, equipment tools, service, and incidentals to complete all work required by these specifications and as shown on the drawings and as directed by the engineer/architect.
- B. The Contractor shall perform the work and make ready for use of the building. If any damages to existing equipment or the building are made during construction, contractor will rectify at his own cost.
- C. Furnish and install all materials, equipment, and labor which is reasonably and properly inferable and necessary for the proper completion of the work, whether specially indicated in the Contract documents or not.
- D. Protect all existing building components and contents from damage. It is intended that any existing building components and contents in place shall be repaired to original condition if damaged by work of this Contract.
- E. Contractor shall verify all field and project conditions prior to preparing his bid. Any conditions not described in these drawings and specifications shall be brought to the attention of the A/E ten (10) days prior to bid date. Failure to do so shall render the contractor responsible for correction of this condition should he be awarded the contract.
- F. The work “provide” as used in these specifications and on the drawings will be termed to mean “furnish and install”.
- G. Visit and examine the project site with all authorities concerned in order to become familiar with all existing conditions pertinent to the work to be

performed thereon. No additional compensation will be allowed for failure to be so informed.

- H. All work shall be performed in a neat and workmanlike manner and in accordance with all codes, standards, and requirements of the industry.
- I. Check all specifications and all drawings and bring to the attention of the A/E any conflicts or variations as shown or noted.
- J. Specifications and accompanying drawings apply to all material and / or labor for construction of work specified herein and shown on drawings.
- K. The Contractor shall pay for all taxes, license, and permits required for execution of the work. Note: This is a sales tax-exempt project. Refer to the Front-End documents in Bid Package.
- L. For any points which are not clear, or from items and/or details which the Contractor feels are in need of clarification, provide request of clarifications in writing to HANO's Procurement Department. Refer to Front-End Documents in Bid Package.
- M. The drawings and the specifications are complementary and what is shown and/or called for shall be furnished and installed the same as if shown and/or called for in the other.
- N. In case of discrepancies and/or ambiguities in the drawings and/or in the specifications, submit requests for clarifications in writing to HANO's Procurement Department. Refer to the Front-End Documents in the Bid Package. Failure to do so on the part of the successful bidder shall be construed as explicit agreement on his part to abide by the A/E's decision in such matters.

1.4 WORK SEQUENCE

- A. Work to be sequenced as indicated in the documents. Access shall be restricted to the mechanical room as indicated on the documents. Access to other areas of Guste High-rise shall be coordinated and approved with Guste property management and HANO.
- B. Contractor to coordinate any shut-downs of utilities with the A/E and Guste management. Prior approval must be received by the contractor prior to the shut-down of any utilities or equipment.

1.5 CONTRACTOR USE OF PREMISES

- A. Confine operations at site to areas permitted by law, ordinances, permits, Contract documents, and the Owner.
- B. Do not unreasonably encounter the site with materials or equipment. Assume full responsibility for protection and safekeeping of products stored on premises. Move stored products which interfere with operation of Owner.
- C. Do not load structures with weight that will endanger structure.
- D. Use of site – Limit use of site for work and storage. Coordinate parking areas, materials delivery, and storage areas at site with Architect, HANO and Property Manager of GHRMC.

- E. In no case shall the work interfere with existing streets, drives, walks, passageways, exit access ways, pedestrian traffic, and the like. Comply with provisions of the contract and regulatory of the contract and regulatory ordinances.
- F. Contractor shall at all times conduct his operations to ensure the least inconvenience to the general public.

1.6 CONSTRUCTION AREAS

- A. Contractor shall limit his use of the construction areas for work and for storage to allow for work by other contractors, Owner's use, and public use as applicable.
- B. Assume full responsibility for the protection and safekeeping of products under this contract stored on site.
- C. Move any stored products under Contractor's control which interfere with operations of the Owner or separate contractor.
- D. Obtain and pay for the use of additional storage or work areas needed for operation.
- E. It is assumed there will be no need for street closures on this project. Should the need arise, the Contractor shall submit for and obtain the permits required for any street closures.

END OF SECTION

SECTION 01045

CUTTING AND PATCHING

PART 1 - GENERAL

1.1 RELATED DOCUMENTS

Drawings and general provisions of contract, including General and Supplementary Conditions and Division-1 Specification Sections apply to work of this Section.

1.2 SCOPE OF WORK

The work done under this section includes the furnishing of all labor, materials, equipment, and services necessary to complete the cutting, fitting, and patching required in the execution of this Project.

1.3 DESCRIPTION

Contractor shall be responsible for all cutting, fitting, and patching, required to complete the work and/or to:

- A. Make its several parts fit together properly.
- B. Uncover portions of the work to provide for installation of proposed work.
- C. Remove and replace defective work.
- D. Remove and replace work not conforming to requirements of the Contract documents.

1.4 SUBMITTALS

- A. For cutting not indicated to be performed in the documents, submit a written request to A/E three (3) working days in advance of executing any cutting or alteration which affects:
 - 1. The structural value or integrity of any element of the Project.
 - 2. The integrity or effectiveness of weather-exposed or moisture-resistant elements or systems.
 - 3. The efficiency, operational life, maintenance, or safety of operational elements.
 - 4. The visual quality of sight-exposed elements.
- B. The request shall include:
 - 1. Identification of the Project.
 - 2. Description of the affected work.

3. The necessity for cutting, alteration, or excavation.
 4. The effect on the structural or weatherproof integrity of the Project.
 5. Description of the proposed work:
 - a. The scope of cutting, patching, alteration, or excavation.
 - b. The trades who will execute the work.
 - c. Products proposed to be used.
 - d. The extent of refinishing to be done.
 6. Alternatives to cutting and patching.
 7. Cost proposal, when applicable.
- C. Should conditions of the work or the schedule indicate a change of products from the original installation, Contractor shall submit a request for substitution.
- D. Submit a written notice to A/E designating the date and the time the work will be uncovered.

PART 2 - PRODUCTS

2.1 MATERIALS

Comply with specifications and standards for each specific product involved.

PART 3 - EXECUTION

3.1 INSPECTION

- A. Inspect existing conditions of the Project, including elements subject to damage or to movement during cutting and patching.
- B. After uncovering work, inspect the conditions affecting the installation of products or performance of the work.
- C. Report unsatisfactory or questionable conditions to the A/E in writing; do not proceed with the work until the A/E has provided further instructions.

3.2 PREPARATION

- A. Provide adequate temporary support as necessary to assure the structural value or integrity of the affected portion of the work.
- B. Provide devices and methods to protect other portions of the Project from damage.
- C. Provide protection from the elements for that portion of the Project which may be exposed by cutting and patching work.
- D. The Contractor shall be responsible for and shall properly protect all conduit, wires, equipment, drains, pipes, and other property of the Owner's or public service corporations which are not noted to be demolished or removed.

3.3 PERFORMANCE

- A. Execute cutting and patching by methods which will prevent damage to existing building components and contents and will provide proper surfaces to receive installation of repairs.
- B. Execute fitting and adjustment of products to provide a finished installation to comply with specified products, functions, tolerances, and finishes.
- C. Restore work which has been cut or removed; install new products to provide completed work in accordance with requirements of Contract documents.
- D. Fit work airtight to pipes, sleeves, ducts, conduit, and other penetrations through surfaces.
- E. Refinish entire surfaces as necessary to provide an even finish to match adjacent finishes.
 - 1. For continuous surfaces, refinish to nearest expansion joint.
 - 2. For an assembly, refinish the entire unit.

END OF SECTION

SECTION 01300

SUBMITTALS

PART 1 – GENERAL

1.1 GENERAL:

- A. This specification Section is intended to augment the provisions of Division 0 documents. The specific requirements of those documents shall supersede in the event of direct conflict with any provision of this specification Section as stated herein.

1.2 DESCRIPTION OF WORK:

- A. This Section specifies administrative and procedural requirements for submittals required for performance of the Work, including:
 - 1. Submittal Schedule
 - 2. Shop Drawings
 - 3. Product Data
 - 4. Samples
- B. Administrative Submittals:
 - 1. Refer to Division-1 and other Contract Documents for requirements for administrative submittals. Such submittals include, but are not limited to:
 - a. Permits
 - b. Applications for payment
 - c. Performance and payment bonds
 - d. Insurance Certificates

1.3 SUBMITTAL PROCEDURES:

- A. Submittal Preparation:
 - 1. Place a permanent label, title block, or submittal data sheet (sample at end of this Section) attached to each individual submittal for identification.
 - 2. Include the following information on the label for processing and recording action taken:
 - a. Project name
 - b. Date
 - c. Name and address of Architect
 - d. Name and address of General Contractor
 - e. Name and address of Owner
 - f. Name, phone number and address of subcontractor
 - g. Name, phone number and address of supplier
 - h. Name and phone number of manufacturer and his representative
 - i. Number and title of appropriate Specification Section and Article/ Paragraph, as appropriate
 - j. Drawing number and detail references, as appropriate
 - k. General Contractor's review stamp
 - l. Area for Architect's review comments

1.4 SUBMITTAL SCHEDULE:

- A. The General Contractor shall prepare and submit to the Architect prior to the Date of Commencement a schedule of Shop Drawings and Submittals as required in the Contract Documents. Schedule shall fix dates for submission, and the lead time for each submittal as related to requirements for return receipt for submittal to expedite delivery of material to maintain Progress Schedule. It is to be understood that this Schedule will be subject to change from time to time in accordance with the progress of the work.
- B. Coordinate submittal schedule with the list of subcontracts, schedule of values and the list of products as well as the General Contractor's construction schedule.
- C. Submittal log shall be updated by the General Contractor monthly until all submittals are approved by the Architect and related Consultants.

1.5 STAFF NAMES:

- A. Within ten (10) days after the Notice to Proceed, submit a list of the General Contractor's principal staff assignments, including the Project Manager, Superintendent and other personnel in attendance at the site; identify individuals, their duties and responsibilities; list their addresses and telephone numbers (including emergency telephone numbers).

1.6 LIST OF SUBCONTRACTORS:

- A. The list of subcontractors required shall be submitted to the Architect no later than ten (10) days from the Date of Commencement. This list shall include the names of manufacturers, material suppliers, and installers proposed for each of the products, equipment, and materials to be incorporated into this project.
- B. The General Contractor shall furnish upon request adequate data on any named entity on the list in order to permit the Architect and Owner to conduct a proper evaluation. Failure to object to a manufacturer shall not constitute a waiver of any of the requirements of the Contract Documents, and all products furnished by the listed manufacturer must conform to such requirements.

1.7 SHOP DRAWINGS:

- A. General:
 - 1. Each submittal shall be complete with a "Submittal Data" sheet completely filled out with all requested information including the General Contractor's stamp. A sample "Submittal Data" sheet is included at the end of this section.
 - 2. All submittals shall be dated and shall contain the project name; description or names of equipment; materials or equipment which are to be installed, reference to the Section of Specifications where it is specified and Drawing number where shown.
- B. Shop Drawings:
 - 1. Submit legible, reproducible prints of each drawing. Each drawing shall have a clear space for stamps. When phrase "by others" appears on Shop Drawings, General Contractor shall indicate on drawing who is to furnish material or operations so marked before submittal. When Shop Drawings are checked "resubmit", or words of like meaning, General Contractor shall correct and submit new reproducible prints for approval to the Architect. After completion of checking of each submission of Shop Drawings, the Architect will return prints to General Contractor. For use of all trades, the General Contractor shall provide such numbers of prints as are required for field distribution.
 - 2. General Contractor shall review and approve submittals prior to submission to Architect.

Failure to do so may result in return of submittal to General Contractor without Architect's review.

3. By approving and submitting Shop Drawings, Product Data, Samples and similar submittals, General Contractor represents that he has determined and verified materials, field measurements and field construction criteria related thereto, or will do so, and has checked and coordinated the information contained within such submittals with the requirements of the Work and the Contract Documents.
4. The responsibility for coordinating the Shop Drawings including technical data, capability (warranted and implied), sizing, color, texture, etc. shall be the sole responsibility of the General Contractor. The coordination between subcontractor and/ or material supplier shall be the responsibility of the General Contractor. The Project Coordinator shall be responsible to supervise this activity.
5. The Architect will review each of the General Contractor's submittals one initial time and, should resubmittal be required, one additional time to verify that the reasons for resubmittal have been addressed by the General Contractor and corrections made. Should additional resubmittals be required, the General Contractor shall reimburse the Owner for all costs incurred including the cost of the Architect's services made necessary to review such additional resubmittals.

C. Sheet Size:

1. Submit Shop Drawings on sheets 30" x 42" or 24" x 36".
2. HANO copy of approved shop drawings shall be on 11"x17" and in PDF on flash 23 drives(s). Flash drive(s) shall be labeled: R \$ R Boilers AT GUSTE - SHOP DRAWINGS.

1.8 SAMPLES:

- A. Unless otherwise specifically directed by the Architect, all Samples shall be of the precise article proposed to be furnished.
- B. Where variation in color, pattern, texture or other characteristics are inherent in the material or product represented, submit multiple units (not less than 3), that show approximate limits of the variations.
- C. Refer to Specifications for requirements for Samples that illustrate workmanship, fabrication techniques, details of assembly, connections, operation and similar construction characteristics.
- D. Submit all Samples in the quantity which is required to be returned plus one which will be retained by the Architect.

1.9 DELIVERABLES OF SUBMITTALS:

- A. Submit to HANO shall receive one (1) hard copy and one (1) electronic copy in PDF on flash drive(s) of all "Approved" submittals. Flash drive(s) shall be labeled: R& R WATER SOFTNER AT GUSTE SHOP DRAWINGS..

PART 2 – PRODUCTS

Not applicable

PART 3 – EXECUTION

Not applicable

SEE SAMPLE SUBMITTAL DATA SHEET NEXT PAGE

END OF SECTION _____

SUBMITTAL DATA

SUBMITTAL DATE:

NAME OF PROJECT:

OWNER:

ARCHITECT:

CONTRACTOR:

SUBCONTRACTOR:

SUPPLIER/ MANUFACTURER:

SPECIFICATION DIVISION NO.:

SPECIFICATION PARAGRAPH NO.:

DRAWING REFERENCE: CONTRACTOR'S

APPROVAL STAMP:

SECTION 01370 – SCHEDULE OF VALUES

PART 1 - GENERAL

1.1 SUBMITTAL

- A. Prior to the date of the Pre-construction meeting, the Contractor shall submit to A/E a Schedule of Values for review by A/E, allocating a dollar value for activities on the construction schedule.

1.2 FORM AND CONTENT OF SCHEDULE OF VALUES

- A. The dollar value for the activity shall be the cost of the work including labor, materials, and pro rata contribution of his general condition requirements, overhead, and profit.
- B. The sum of all activity costs shall equal the total contract amount.
- C. Each activity cost for the Schedule of Values shall be coded with a cost code corresponding to the trade, subcontractor, or supplier performing the work so that subtotals for each division of the work can be prepared.
- D. The Schedule of Values shall, in the best judgment of the Contractor, represent a fair, reasonable, and equitable dollar (cost) allocation for activities on the construction schedule.
- E. The Schedule of Values, unless objected to by the A/E or Owner, shall be used as a basis for the Contractors' pay request.
- F. The Schedule of Values shall be provided in the level of detail as required by the Owner.
- G. The final Schedule of Values must be submitted to A/E and Owner a minimum of ten (10) business days prior to the submittal of the first Applications for Payment.

END OF SECTION

SECTION 01600 - MATERIALS AND EQUIPMENT

PART 1 - GENERAL

1.1 RELATED DOCUMENTS

- A. Drawings and general provisions of the contract, including General and Supplementary Conditions and Division-1 Specification Sections apply to the work of this Section.

1.2 MATERIAL AND EQUIPMENT INCORPORATED INTO THE WORK

- A. Materials and equipment shall be new except where otherwise indicated, of the best quality, with the same brand of manufacturer for all similar material.
- B. Conform to applicable specifications and standards.
- C. Comply with size, make, type, and quality specified, or as specifically approved in writing by the A/E.
- D. Manufactured and fabricated products:
 - 1. Design, fabricate, and assemble in accordance with the best engineering and shop practices.
 - 2. Manufacture like parts of duplicate units to standard sizes and gages, to be interchangeable.
 - 3. Two (2) or more items of the same kind shall be identical, by the same manufacturer.
 - 4. Products shall be suitable for service conditions.
 - 5. Equipment capacities, sizes, and dimensions shown or specified shall be adhered to unless variations are specifically approved in writing.
- E. Do not use material or equipment for any purpose other than that for which it is designed or is specified.

1.3 MANUFACTURER'S INSTRUCTIONS

- A. When contract documents require that installation of work shall comply with manufacturer's printed instructions, obtain and distribute copies of such instructions to parties involved in the installation, including two (2) copies to A/E. Maintain one (1) set of complete instructions at the job site during installation and until completion.

- B. Handle installs, connect, clean, condition, and adjust products in strict accordance with such instructions and in conformity with specified requirements.
 - 1. Should job conditions or specified requirements conflict with manufacturer's instructions, consult with A/E for further instructions.
 - 2. Do not proceed with work without clear instructions.
- C. Perform work in accordance with manufacturer's instructions. Do not omit any preparatory step or installation procedure unless specifically modified or exempted by contract documents.

1.4 TRANSPORTATION AND HANDLING

- A. Arrange deliveries of products in accordance with construction schedules. Coordinate to avoid conflict with work and conditions at the site.
 - 1. Deliver products in undamaged condition in manufacturer's original containers or packaging, with identifying labels intact and legible.
 - 2. Immediately on delivery, inspect shipments to assure compliance with requirements of contract documents and approved submittals, and that products are properly protected and undamaged.
- B. Provide equipment and personnel to handle products by methods to prevent soiling or damage to products or packaging.

1.5 STORAGE AND PROTECTION

- A. Store products in accordance with manufacturer's instructions, with seals and labels intact and legible.
 - 1. Store products subject to damage by the elements in weather-proof enclosures.
 - 2. Maintain temperature and humidity within the ranges required by manufacturer's instructions.
- B. Exterior storage:
 - 1. Store fabricated products above the ground, on blocking or skids, to prevent soiling or staining. Cover products, which are subject to deterioration with impervious sheet coverings to provide adequate ventilation to avoid condensation.
 - 2. Store loose granular materials in a well-drained area on solid surfaces to prevent mixing with foreign matter.

- C. Arrange storage in a manner to provide easy access for inspection. Make periodic inspections of stored products to assure that products are maintained under specified conditions and free from damage or deterioration.
- D. Protection after installation - Provide substantial coverings as necessary to protect installed products from damage from traffic and subsequent construction operations. Remove when no longer needed.

1.6 SUBSTITUTIONS AND PRODUCT OPTIONS

- A. Products list - Within five (5) days after contract date, submit to A/E a complete list of major products proposed to be used, with the name of the manufacturer and the installing subcontractor.
- B. Contractor's options:
 - 1. For products specified only by reference standard, select any product meeting that standard.
 - 2. For products specified by naming several products or manufacturers, select any one of the products or manufacturers named which comply with the specifications.
 - 3. For products specified by naming one (1) or more products or manufacturers and "or approved equal," Contractor must submit a request for prior approval seven (7) day calendar days prior to bid date for substitutions for any product or manufacturer not specifically named.
- C. Substitutions:
 - 1. Substitutions are only allowed by approval seven (7) calendar days prior to bid date or as may be stipulated in the Instructions to Bidders or Supplementary Conditions.
 - 2. If a product that is specified becomes unavailable due to no fault of the Contractor, an item that has been approved prior to bid date may be substituted.
 - 3. If prior approved items are unavailable or if no prior approval exists for the unavailable item, the A/E will consider written requests from Contractor for substitution of products.
 - 4. Submit a separate request for each product, supported with complete data, with drawings and samples as appropriate, including:

- a. Comparison of the qualities of the proposed substitution with that specified.
 - b. Changes required in other elements of the work because of the substitution.
 - c. Effect on the construction schedule.
 - d. Cost data comprising the proposed substitution with the product specified.
 - e. Any required license fees or royalties.
 - f. Availability of maintenance service and source of replacement materials.
- D. Contractor's representation - A request for a substitution constitutes a representation that the Contractor:
1. Has investigated the proposed product and has determined that it is equal to or superior in all respects to that specified.
 2. Will provide the same warranties or bonds for the substitution as for the product specified.
 3. Will coordinate the installation of an accepted substitution into the work and make such other changes as may be required to make the work complete in all respects.
 4. Waives all claims for additional costs under his responsibility, which may subsequently become apparent.
- E. A/E will review requests for substitutions with reasonable promptness and notify Contractor in writing of the decision to accept or reject the requested substitution.

END OF SECTION

SECTION 01700 - PROJECT CLOSEOUT

PART 1 – GENERAL

1.1 DESCRIPTION OF WORK:

A. Work Included in This Section:

1. This Section specifies administrative and procedural requirements for project closeout, including, but not limited to, the following:
 - a. Inspection procedures
 - b. Project record document submittal
 - c. Operating and maintenance manual submittal
 - d. Submittal of warranties
2. Closeout requirements for specific construction activities are included in the appropriate Sections.

1.2 RELATED WORK:

- A. Division 0 – General Conditions of the Contract
- B. Division 0 – HUD General Conditions (Form 5370) and Supplemental Conditions
- C. Division 0 – Supplemental Conditions
- D. Section 01300 – Submittals

1.3 SUBSTANTIAL COMPLETION

A. General:

1. The Work will only be considered suitable for Substantial Completion when all work indicated in the bid documents is complete and performing its intended function. The project shall be complete in its entirety.

B. Forms:

1. All forms to be used shall be American Institute of Architect (AIA) forms, unless noted otherwise.

C. Preliminary Procedures: Before requesting inspection for certification of Substantial Completion, complete the following. List exceptions in the request.

1. The General Contractor considers the Work, or a portion thereof which the Owner agrees to with no separation, is substantially complete, the General Contractor shall prepare and submit to the Architect a comprehensive list of items to be completed or corrected prior to final payment. Failure to include an item on such list does not alter the responsibility of the General Contractor to complete all Work in accordance with the Bidding and Contract Documents.

2. Advise Owner of pending insurance change-over requirements and submit consent of surety.
3. Submit specific warranties, workmanship bonds, maintenance agreements, final certifications and similar documents.
4. Obtain and submit releases enabling the Owner unrestricted use of the Work and access to services and utilities; include occupancy permits, operating certificates and similar releases.
5. Deliver tools, spare parts, extra stock, and similar items.
6. Complete start-up testing of systems, and instruction of the Owner's operating and maintenance personnel. Discontinue or change over and remove temporary facilities from the site, along with construction tools, mock-ups, and similar elements.
7. Remove temporary facilities, construction equipment and temporary services. Restore disturbed items to original condition or better.
8. Complete final cleanup requirements, including touch-up painting. Touch-up and otherwise repair and restore marred exposed finishes.
9. Contractor is required to file the Certificate of Substantial Completion with the Orleans Parish Recorder of Mortgages.
10. Submit all Final Inspections Certificates along with a Use and Occupancy Certificate.
11. Submit Consent of Surety to Final Payment (AIA G707).

D. Re-inspection Procedure:

1. In the event that more than the two inspections by the Architect described above are made necessary by the failure of the General Contractor to complete the Work, or to complete or correct items identified on the list of such items, the General Contractor shall reimburse the Owner for all costs incurred including the cost of the Architect's services made necessary thereby.

1.4 FINAL ACCEPTANCE:

- A. At the completion of the Project prior to receiving final payment, the General Contractor shall furnish the Owner, through the Architect, properly signed and notarized waivers of lien from all subcontractors employed and material suppliers furnishing materials for the Project. Such waivers shall be submitted before final payment will be certified by the Architect to the Owner (AIA G706A). Also, at the completion of the contract, the General Contractor shall provide documentation for the signature of the Owner and General Contractor signifying the completion of the contractual obligation and the cancellation of the contract. This documentation shall be filed by the Contractor with the Recorder of Mortgages and proof of contract cancellation provided to the Owner. Upon completion of these items, final payment shall be due to the General Contractor.

B. Preliminary Procedures:

1. Before requesting final inspection for final payment, complete the following (list exceptions in the request):
 - a. Submit a copy of the Architect's final inspection list of items to be completed or corrected, stating that each item has been completed or otherwise resolved for

acceptance (by initialing each individual item), and the list has been endorsed and dated by the Architect

- b. Submit record drawings, maintenance manuals, final project photographs, and similar final record information
- c. Submit Consent of Surety to Final Payment (AIA G707)
- d. Submit evidence of final, continuing insurance coverage complying with insurance requirements
- e. Guarantees, Warranties and Bonds
- f. Spare parts and Maintenance Materials
- g. Certificate of Insurance for Products and Completed Operations
- h. Certificate of Occupancy, if required
- i. All remnants required by the Contract Documents
- j. Any other items as required by the Architect and/ or Owner
- k. Clear L&P Certificate

1.5 RECORD DOCUMENT SUBMITTALS:

A. General:

1. The General Contractor shall record on the Record Drawings maintained at the site all changes and selections made during construction and shall locate by dimensions showing actual field measurements of all major items which will be concealed in the completed work. These items shall include location of piping installed, repaired or replaced and items above hard ceilings such as repairs of ducts, piping, etc.
2. Dimensions are to be taken from face of building lines to centerline of piping or conduit.
3. Do not use record documents for construction purposes; protect from deterioration and loss in a secure, fire-resistive location; provide access to record documents for the Architect's reference during normal working hours.

B. Record Drawings:

1. Provide one (1) print copy of record drawings.
2. Record drawings shall be provided in the form of reproducible drawing sheets (reproducible bond) and reflect changes in the work and locations of concealed items for all trades including plumbing, mechanical, electrical and general construction. Bond prints of the original contract documents may be purchased from the Architect at the Architect's standard printing rate.
3. Mark the set to show the actual installation where the installation varies substantially from the Work as originally shown.
4. Mark whichever drawing is most capable of showing conditions fully and accurately; where Shop Drawings are used, record a cross-reference at the corresponding location on the Contract Drawings. Give particular attention to concealed elements that would be difficult to measure and record at a later date.
5. Mark new information that is important to the Owner, but was not shown on Contract Drawings or Shop Drawings.
6. Note related Change Order numbers where applicable.

C. Record Specifications:

1. Maintain one (1) complete copy of the Project Manual, including addenda, and one (1) copy of other written construction documents such as Change Orders and modifications issued in printed form during construction. Mark these documents to show variations in actual Work performed in comparison with the text of the Specifications and modifications.
2. Give particular attention to substitutions, selection of options and similar information on elements that are concealed or cannot otherwise be readily discerned later by direct observation. Note related record drawing information and Product Data.
3. Upon completion of the Work, submit record Specifications to the Architect for the Owner's records.

D. Shop Drawings:

1. Provide one (1) print copy of reviewed shop drawings (include all review comments from Architect and Consultants).
2. Deliver General Contractor's approved copy of all shop drawings submitted during the course of the project.

E. Miscellaneous Record Submittals:

1. Refer to other Specification Sections for requirements of miscellaneous record-keeping and submittals in connection with actual performance of the Work. Immediately prior to the date or dates of Substantial Completion, complete miscellaneous records and place in good order, properly identified and bound or filed, ready for continued use and reference. Submit to the Architect for the Owner's records.

F. Electronic Record Documents:

1. Provide three (3) copies of electronic version on three (3) separate flash or thumb drive of sufficient capacity including record drawings, record specifications, shop drawings, miscellaneous record submittals, maintenance manuals, instructions, and warranties.

1.6 MAINTENANCE MANUAL AND INSTRUCTIONS:

- A. General Contractor shall, prior to completion of Contract, deliver to the Architect three (3) copies of a manual, assembled, indexed, and bound; presenting for the Owner's guidance, full details for care and maintenance of mechanical, electrical, and other equipment included in Contract. Manuals shall include parts lists for each item of equipment furnished under the Contract.
- B. General Contractor shall, for this manual, obtain from Subcontractors, literature of manufacturers relating to equipment, including motors; also furnish cuts, wiring diagrams, instruction sheets, and other information pertaining to same that will be useful to Owner in overall operation and maintenance. Include also, the name, address, and phone number of the nearest sales and service organization for each item.

C. General:

1. Organize each manual into separate Sections for each piece of related equipment.
2. Index all data as per the Table of Contents.
3. As a minimum each manual shall contain a title page, a table of contents, copies of Product Data, supplemented by drawings and written text, and copies of each warranty, bond and service Contract issued.

D. Binders:

1. Identify each binder on the front and spine, with the typed or printed title "OPERATION AND MAINTENANCE MANUAL", Project title or name, and subject matter covered. Indicate the volume number for multiple volume sets of manuals.
2. The binders shall be hard-cover, three-ring slant-D notebook, embossed with the name of the project, spring-lock metal label holders, and piano hinge edges, (2" capacity) 11" x 8-1/2" with heavy duty rings. Provide the number of binders required to properly contain all information required.

E. Drawings:

1. Where drawings or diagrams are required as part of the manual, provide reinforced punched binder tabs on the drawings and bind in with the text.
2. Where oversize drawings are necessary, fold the drawings to the same size as the text pages and use as a fold-out.
3. If drawings are too large to be used practically as a fold-out, place the drawing, neatly folded, in the front or rear pocket of the binder. Insert a typewritten page indicating the drawing title, description of contents and drawing location at the appropriate location in the manual.

F. Protective Plastic Jackets:

1. Provide protective transparent plastic jackets designed to enclose diagnostic software for computerized electronic equipment if required.

G. Text Material:

1. Where written material is required as part of the manual use the manufacturer's standard printed material, or if it is not available, specially prepared data, neatly typewritten, on 8-1/2" by 11", 20 pound white bond paper.
2. Such data called for under separate Sections of the Specifications, shall be included in the manual described in this Section.

H. Title Page:

1. Provide a title page in a transparent plastic envelope as the first sheet of each manual. Provide the following information:
 - a. Subject matter covered by the manual

- b. Name and address of the Project
- c. Date of submittal
- d. Name, address, and telephone number of the Contractor
- e. Name and address of the Architect
- f. Cross reference to related systems in other operating and maintenance manuals

I. Table of Contents:

1. After the Title Page, include a typewritten table of contents for each volume, arranged systematically according to the Project Manual format. Include a list of each product included, identified by product name or other appropriate identifying symbol and indexed to the content of the volume.
2. Where more than one volume is required to accommodate data for a particular system, provide a comprehensive table of contents for all volumes in each volume of the set.

J. General Information:

1. Provide a general information Section immediately following the Table of Contents, listing each product included in the manual, identified by product name. Under each product, list the name, address, and telephone number of the Subcontractor or installer, and the maintenance contractor. Clearly delineate the extent of responsibility of each of these entities. In addition, list a local source for replacement parts and equipment.

K. Product Data:

1. Where manufacturer's standard printed data is included in the manuals, include only sheets that are pertinent to the part or product installed. Mark each sheet to identify each part or product included in the installation. Where more than one item in a tabular format is included, identify each item, using appropriate references from the Contract Documents. Identify data that is applicable to the installation and delete references to information that is not applicable.

L. Written Text:

1. Where manufacturer's standard printed data is not available, and information is necessary for proper operation and maintenance of equipment or systems, or it is necessary to provide additional information to supplement data included in the manual, prepare written text to provide necessary information. Organize the text in a consistent format under separate headings for different procedures. Where necessary, provide a logical sequence of instruction for each operating or maintenance procedure.

M. Warranties, Bonds and Service Contracts:

1. Provide original copies of each warranty, bond or service contract in the appropriate manual for the information of the Owner's operating personnel. Provide written data outlining procedures to be followed in the event of product failure. List circumstances

and conditions that would affect validity of the warranty or bond.

1.7 INSTRUCTIONS:

- A. The Owner's delegated representative shall be given personal instructions by trained personnel, in the care, use, maintenance, and operation procedures for each item. This shall be done in accordance with, and in addition to, the above required manual.

- B. Operating and Maintenance Instructions:
 - 1. Arrange for each installer of equipment that requires regular maintenance to meet with the Owner's personnel to provide instruction in proper operation and maintenance. If installers are not experienced in procedures, provide instruction by manufacturer's representatives. Include a detailed review of the following items:
 - a. Maintenance manuals
 - b. Record documents
 - c. Spare parts and materials
 - d. Tools
 - e. Identification systems
 - f. Control sequences

 - 2. As part of instruction for operating equipment, demonstrate the following procedures:
 - a. Start-up
 - b. Shutdown
 - c. Emergency operations
 - d. Noise and vibration adjustments
 - e. Safety procedures
 - f. Economy and efficiency adjustments
 - g. Effective energy utilization

- C. Maintenance Procedures:
 - 1. Provide information detailing essential maintenance procedures, including the following:
 - a. Routine operations
 - b. Trouble-shooting guide
 - c. Disassembly, repair and reassembly
 - d. Alignment, adjusting and checking

- D. Operating Procedures:
 - 1. Provide information on equipment and system operating procedures, including the following:
 - a. Start-up procedures
 - b. Equipment or system break-in

- c. Routine and normal operating instructions
 - d. Regulation and control procedures
 - e. Instructions on stopping
 - f. Shut-down and emergency instructions
 - g. Summer and winter operating instructions
 - h. Required sequences for electric or electronic systems
 - i. Special operating instructions
- E. Servicing Schedule:
- 1. Provide a schedule of routine servicing and lubrication requirements, including a list of repaired lubricants for equipment with moving parts.
- F. Controls:
- 1. Provide a description of the sequence of operation and as-installed control diagrams by the control manufacturer for systems requiring controls.
- G. Coordination Drawings:
- 1. Provide each Contractor's Coordination Drawings.
 - 2. Provide as-installed color-coded piping diagrams, where required for identification.
- H. Valve Tags:
- 1. Provide charts of valve tag numbers, with the location and function of each valve.

PART 2 – PRODUCTS

Not Applicable

PART 3 – EXECUTION

Not Applicable

END OF SECTION

SECTION 223100 - DOMESTIC WATER SOFTENERS

PART 1 - GENERAL

1.1 SUMMARY

- A. Section Includes:
 - 1. Water softeners.
 - 2. Chemicals.
 - 3. Water-testing sets.

1.2 ACTION SUBMITTALS

- A. Product Data: For each type of product.
- B. Shop Drawings:
 - 1. Include diagrams for power, signal, and control wiring.

1.3 INFORMATIONAL SUBMITTALS

- A. Source quality-control reports.
- B. Field quality-control reports.
- C. Sample warranty.

1.4 CLOSEOUT SUBMITTALS

- A. Operation and maintenance data.
- B. Service contract for 1 year.

1.5 WARRANTY

- A. Special Warranty: Manufacturer agrees to repair or replace components of water softeners that fail in materials or workmanship within specified warranty period.
 - 1. Water Softeners, Warranty Period: From date of Substantial Completion.
 - a. Mineral Tanks: 5 years.
 - b. Brine Tanks: 10 years.
 - c. Control Valve: 1 year.

PART 2 - PRODUCTS

2.1 PERFORMANCE REQUIREMENTS

- A. Drinking Water System Components - Health Effects and Drinking Water System Components - Lead Content Compliance: NSF 61 and NSF 372.
- B. Capacities and Characteristics:
 - 1. Water Analysis:
 - a. Hardness: 11 grains/gal.
 - b. Iron: 0 ppm.
 - c. Inlet Water Pressure: 30-100 psig.
 - d. Water Temperature: 35-100 deg F.
 - 2. Design Flow Rate: 60 gpm at 1.2 psi pressure drop
 - 3. Continuous Service Flow Rate: 87 gpm at 15-psig pressure drop.
 - 4. Peak Service Flow Rate: 110 gpm at 25-psig pressure drop.
 - 5. Manifold Pipe Size: 2 NPS.
 - 6. Backwash-to-Drain: 30 gpm
 - 7. Water Consumption: 86,400 gal./day.
 - 8. Water Demand: 24 hrs/day
 - 9. Number of Mineral Tanks: Two.
 - 10. Mineral Quantity, Each Tank: 475 cu. ft.
 - 11. Mineral Exchange Capacity: 600,000 grains/cu. ft. per 300 lb of salt.
 - 12. Electrical Characteristics:
 - a. Volts: 120 V.
 - b. Phases: 1
 - c. Hertz: 60 Hz.
 - 13. Salt Storage Capacity: 1700 lb.
 - 14. Minimum Number of Regenerations per Refill: 5.9
 - 15. Floor Area Required: 50 sq. ft.
 - 16. Height Required: 100 inches.

2.2 WATER SOFTENERS

- A. Description: Factory-assembled, pressure-type water softener.
 - 1. Configuration: Twin unit with two mineral tanks and one brine tank.
 - 2. Mounting: On skids.
 - 3. Wetted Components: Suitable for water temperatures from 40 to at least 100 deg F.
 - 4. Mineral Tanks: FRP, pressure-vessel quality.
 - a. Construction: Fabricated and stamped to comply with ASME Boiler and Pressure Vessel Code: Section X, "Fiber-Reinforced Plastic Pressure Vessels."

- b. Pressure Rating: 150 psig minimum.
 - c. Freeboard: 50 percent minimum for backwash expansion above normal resin bed level.
 - d. Support Legs or Skirt: Constructed of structural steel, welded to tank.
 - e. Upper Distribution System: Single, point type, fabricated from galvanized-steel pipe and fittings.
 - f. Lower Distribution System: Hub and radial-arm or header-lateral type; fabricated from nonmetallic pipe and fittings with individual, fine-slotted, nonclogging plastic strainers, and arranged for even flow distribution through resin bed.
 - g. Liner: PE, ABS, or other material suitable for potable water.
5. Mineral Tanks: Polyethylene; pressure-vessel quality.
- a. Construction: Fabricated and stamped to comply with ASME Boiler and Pressure Vessel Code: Section VIII, "Pressure Vessels," Division 1.
 - b. Pressure Rating: 150 psig minimum.
 - c. Freeboard: 50 percent minimum for backwash expansion above normal resin bed level.
 - d. Support Legs or Skirt: welded to tank.
 - e. Upper Distribution System: Single, point type, fabricated from galvanized-steel pipe and fittings.
 - f. Lower Distribution System: Hub and radial-arm or header-lateral type; fabricated from PVC pipe and fittings with individual, fine-slotted, nonclogging PE strainers, and arranged for even flow distribution through resin bed.
6. Controls: Fully automatic; 120 V; factory wired and factory mounted on unit.
- a. Adjustable duration of various regeneration steps.
 - b. Push-button start and complete manual operation.
 - c. Electric time clock and switch for fully automatic operation, adjustable to initiate regeneration at any hour of day and any day of week or at fixed intervals.
 - d. Sequence of Operation: Multiport pilot-control valve automatically pressure-actuates main operating valve through steps of regeneration and return to service.
 - e. Pointer on pilot-control valve shall indicate cycle of operation.
 - f. Includes means of manual operation of pilot-control valve if power fails.
7. Main Operating Valves: Industrial, automatic, multiport, diaphragm type with the following features:
- a. Slow opening and closing, nonslam operation.
 - b. Diaphragm guiding on full perimeter from fully open to fully closed.
 - c. Isolated, dissimilar metals within valve.
 - d. Self-adjusting, internal, automatic brine injector that draws brine and rinses at constant rate independent of pressure.
 - e. Sampling cocks for soft water.
 - f. Special tools are not required for service.
8. Flow Control: Automatic, to control backwash and flush rates over wide variations in operating pressure; does not require field adjustments.

- a. Meter Control: Each mineral tank is equipped with signal-register-head water meter that produces electrical signal indicating need for regeneration on reaching hand-set total in gallons. Signal will continue until reset.
 - b. Demand-Initiated Control: Each mineral tank of twin mineral-tank unit is equipped with automatic-reset-head water meter that electrically activates cycle controllers to initiate regeneration at preset total in gallons. Head automatically resets to preset total in gallons for next service run. Electrical lockout prevents simultaneous regeneration of both tanks.
9. Brine Tank: Combination measuring and wet-salt storing system.
- a. Tank and Cover Material: Fiberglass, 3/16 inch (4.8 mm) thick; or molded PE, 3/8 inch (9.5 mm) thick.
 - b. Brine Valve: Float operated and plastic fitted for automatic control of brine withdrawal and freshwater refill.
 - c. Size: Large enough for at least four regenerations at full salting.
10. Factory-Installed Accessories:
- a. Piping, valves, tubing, and drains.
 - b. Sampling cocks.
 - c. Main-operating-valve position indicators.
 - d. Water meters.

2.3 CHEMICALS

- A. Mineral: High-capacity, sulfonated-polystyrene, ion-exchange resin that is stable over entire pH range with good resistance to bead fracture from attrition or shock.
 - 1. Exchange Capacity: 30,000 grains/cu. ft. of calcium carbonate of resin when regenerated with 15 lb of salt.
- B. Salt for Brine Tanks: High-purity sodium chloride, free of dirt and foreign material. Rock and granulated forms are unacceptable.

2.4 WATER-TESTING SETS

- A. Description: Manufacturer's standard water-hardness testing apparatus and chemicals with testing procedure instructions. Include metal container suitable for wall mounting.

2.5 SOURCE QUALITY CONTROL

- A. Electrical Components, Devices, and Accessories: Listed and labeled as defined in NFPA 70, by an NRTL, and marked for intended location and application.
- B. ASME Compliance for Steel Tanks: Fabricate and label mineral tanks to comply with ASME Boiler and Pressure Vessel Code: Section VIII, Division 1, where indicated.

- C. ASME Compliance for FRP Tanks: Fabricate and label mineral tanks to comply with ASME Boiler and Pressure Vessel Code: Section X, where indicated.
- D. UL Compliance: Fabricate and label water softeners to comply with UL 979, "Water Treatment Appliances."
- E. Hydrostatically test mineral tanks before shipment to a minimum of one and one-half times the pressure rating.
- F. Prepare test and inspection reports.

PART 3 - EXECUTION

3.1 WATER SOFTENER INSTALLATION

- A. Install brine lines and fittings furnished by equipment manufacturer, but not specified to be factory installed.
- B. Prepare mineral-tank distribution system and underbed for minerals and place specified mineral into mineral tanks.
- C. Install water-testing sets mounted on wall, unless otherwise indicated, and near water softeners.

3.2 PIPING CONNECTIONS

- A. Comply with requirements for piping specified in Section 221116 "Domestic Water Piping." Drawings indicate general arrangement of piping, fittings, and specialties.
- B. Where installing piping adjacent to equipment, allow space for service and maintenance.
- C. Install shutoff valves on raw-water inlet and soft-water outlet piping of each mineral tank, and on inlet and outlet headers.
- D. Install pressure gauges on raw-water inlet and soft-water outlet piping of each mineral tank.
- E. Install valved bypass in water piping around water softeners.
- F. Install indirect wastes to spill into open drains or pit with drain.

3.3 ELECTRICAL CONNECTIONS

- A. Install electrical devices furnished by manufacturer, but not factory mounted, according to NFPA 70 and NECA 1.

3.4 IDENTIFICATION

- A. Identify system components. Comply with requirements for identification specified in Section 220553 "Identification for Plumbing Piping and Equipment."

3.5 FIELD QUALITY CONTROL

- A. Perform tests and inspections with the assistance of a factory-authorized service representative.
- B. Tests and Inspections:
 - 1. Leak Test: After installation, charge system and test for leaks. Repair leaks and retest until no leaks exist.
 - 2. Operational Test: After electrical circuitry has been energized, start units to confirm proper unit operation.
 - 3. Test and adjust controls and safeties. Replace damaged and malfunctioning controls and equipment.
- C. Water softeners will be considered defective if they do not pass tests and inspections.
- D. Prepare test and inspection reports.

3.6 STARTUP SERVICE

- A. Engage a factory-authorized service representative to perform startup service.
 - 1. Complete installation and startup checks according to manufacturer's written instructions.
- B. Add water to brine tanks and fill with the following form of salt:
 - 1. Water Softeners: Processed, plain salt pellets or as required by manufacturer.
- C. Sample water softener effluent after startup and at three consecutive seven-day intervals (total of four samples), and prepare certified test reports for required water performance characteristics. Comply with the following:
 - 1. ASTM D859, "Test Method for Silica in Water."
 - 2. ASTM D1067, "Test Methods for Acidity or Alkalinity of Water."
 - 3. ASTM D1068, "Test Methods for Iron in Water."
 - 4. ASTM D1126, "Test Method for Hardness in Water."
 - 5. ASTM D1129, "Terminology Relating to Water."
 - 6. ASTM D3370, "Practices for Sampling Water from Closed Conduits."

3.7 MAINTENANCE SERVICE

- A. Initial Maintenance Service: Beginning at Substantial Completion, maintenance service shall include 12 months' full maintenance by skilled employees of water softener Installer. Include quarterly preventive maintenance, repair or replacement of worn or defective components,

Appendix B Drawings



GUSTE HIGH-RISE 1301 SIMONE BOLIVAR AVE. NEW ORLEANS LOUISIANA IFB# 23-912-XX REMOVE & REPLACE WATER SOFTENER SYSTEM

ABBREVIATIONS

CLR.	CLEAR
CMU	CONCRETE MASONRY UNIT
CONC.	CONCRETE
DIM. PT.	DIMENSION POINT
EO	EDGE OF
E.F.	EXHAUST FAN
(E)	EXISTING
EX.	EXISTING
EXT.	EXTERIOR
F.F.	FINISH FLOOR
F.O.	FACE OF
FDN	FOUNDATION
GSM	GALVANIZED SHEET METAL
HDG	HOT DIPPED GALVANIZED
LAV.	LAVATORY
MFG.	MANUFACTURER
MTL.	METAL
(N)	NEW
N.I.C.	NOT IN CONTRACT
O.C.	ON CENTER
O/	OVER
PT	PRESSURE TREATED
RA.	RETURN AIR
RAG	RETURN AIR GRILLE
S.A.M.	SELF ADHERING MEMBRANE
SIM	SIMILAR
STL	STEEL
STRL	STRUCTURAL
T.B.D.	TO BE DETERMINED
(TBR&R)	TO BE REMOVED AND REPLACED
T&B	TOP AND BOTTOM
T.O.	TOP OF
(TYP)	TYPICAL
U	UNDERCUT
(UIP)	USE IN PLACE

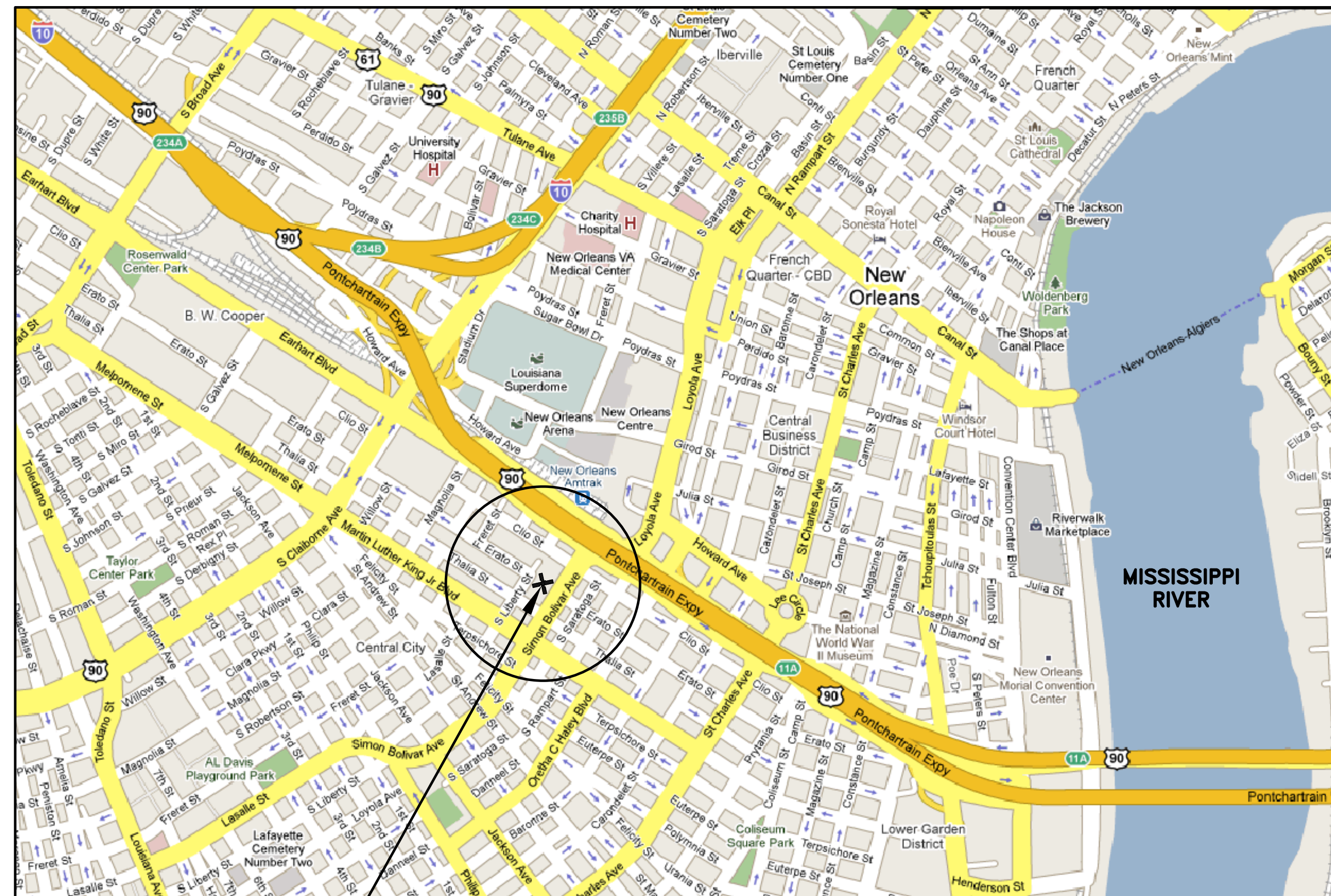

GUSTE HIGH-RISE
PROJECT LOCATION

LOCATION MAP

SHEET INDEX

M0.0	TITLESHEET
M1.0	MECHANICAL NOTES
M1.1	ENLARGED GROUND FLOOR PLAN AT WATER SOFTENER AREA
M1.2	WATER SOFTENER DEMO + DETAILS

ARCHITECT/ENGINEER:

ECM Consultants, Inc.

ENGINEERS – ARCHITECTS – CONSTRUCTION MANAGERS

1301 CLEARVIEW PARKWAY, SUITE 200

METAIRIE, LOUISIANA 70001

PHONE: (504) 885-4080, FAX: (504) 885-1439

Email: mail @ ecmconsultants.com

OWNER:

HANO

HOUSING AUTHORITY OF NEW ORLEANS

4100 TOURO STREET

NEW ORLEANS, LOUISIANA 70122

PHONE: (504) 670-3300

FAX: (504) 286-8788

ECM PROJECT NO. 22462.XX

MAY 2, 2023

THESE PLANS AND SPECIFICATIONS HAVE BEEN PREPARED BY ME,
OR UNDER MY CLOSE PERSONAL SUPERVISION, AND TO THE BEST
OF MY KNOWLEDGE AND BELIEF, THEY COMPLY WITH ALL CITY
AND STATE REQUIREMENTS. I WILL OBSERVE THE WORK.

BY: _____

REGISTRATION No: _____

REVISIONS	BY

ARCHITECT/ENGINEER:
ECM Consultants, Inc.
ENGINEERS – ARCHITECTS – CONSTRUCTION MANAGERS
1301 CLEARVIEW PKWY, SUITE 200
METAIRIE, LOUISIANA 70001
PHONE: (504) 885-4080, FAX: (504) 885-1439
EMAIL: mail@ecmconsultants.com

OWNER:
**HOUSING AUTHORITY
OF NEW ORLEANS**
2051 SENATE ST. BUILDING B, RM. 202
NEW ORLEANS, LOUISIANA 70122

**GUSTE HIGH-RISE
REMOVE/REPLACE WATER SOFTENER SYSTEM
NEW ORLEANS**
LOUISIANA
TITLESHEET

DRAWN	MLM
CHECKED	NGW
DATE	MAY 2, 2023
SCALE	AS SHOWN
JOB NO.	22462.10
SHEET NO.	M0.0
1 OF X SHEETS	

MECHANICAL GENERAL NOTES:

1. WORK REQUIRED UNDER THIS SECTION CONSISTS OF ALL MECHANICAL WORK AND RELATED ITEMS NECESSARY TO COMPLETE THE WORK INDICATED ON THE DRAWINGS AND/OR DESCRIBED IN THE SPECIFICATIONS.
2. SPECIFICATIONS AND ACCOMPANYING DRAWINGS ARE INTENDED TO SHOW AND DESCRIBE COMPLETE MECHANICAL INSTALLATION, FULLY ERECTED, PROPERLY INSTALLED IN WORKMANLIKE MANNER AND LEFT IN PROPER OPERATING CONDITION, WITH CONTRACTOR FURNISHING AND INSTALLING EVERYTHING NECESSARY TO COMPLETE THE JOB.
3. FURNISH ALL LABOR, EQUIPMENT, TOOLS, MATERIALS, ACCESSORIES, ETC., FOR ALL ROUGH-INS AND FINAL CONNECTIONS, COMPLETE, FOR ALL EQUIPMENT INDICATED ON THE DRAWINGS, OR EQUIPMENT FURNISHED BY OTHERS.
4. CHECK MECHANICAL SPECIFICATIONS AND DRAWINGS AND BRING TO ENGINEER'S ATTENTION ANY CONFLICTS OR VARIATIONS AS SOON AS NOTED.
5. PROTECT AGAINST DAMAGE ALL INSTALLED AND EXISTING MATERIAL, EQUIPMENT, MOTORS, FIXTURES, PIPING, INSULATION, ETC.
6. SUPERVISION SHALL BE PROVIDED BY THIS SECTION TO ASSURE THAT WORK IS DONE IN ACCORDANCE WITH GOOD STANDARD PRACTICE AND WORKMANSHIP AND WITH INTENT OF DRAWINGS AND SPECIFICATIONS.
7. ALL CONTRACTORS SUBMITTING BIDS FOR THE WORK UNDER THIS CONTRACT SHALL BE SPECIALISTS IN THEIR FIELD AND SHALL HAVE THE PERSONAL EXPERIENCE, TRAINING AND SKILL TO CONSTRUCT A PROPERLY OPERATING MECHANICAL SYSTEM AS DESCRIBED BY THE CONTRACT DRAWINGS. IF REQUIRED, THE CONTRACTOR SHALL BE ABLE TO FURNISH EVIDENCE OF HAVING EXPERIENCE AND HAVING BEEN RESPONSIBLE FOR AT LEAST THREE PROJECTS COMPARABLE IN SIZE AND COMPLEXITY TO THIS ONE.
8. ALL WORK PERFORMED SHALL BE IN ACCORDANCE WITH BEST STANDARDS OF PRACTICE BY WORKMEN SKILLED AND QUALIFIED IN TYPE OF WORK TO BE DONE. SCHEDULE AND PERFORM MECHANICAL WORK TO AVOID DELAYS TO PROJECT.
9. ALL WORK SHALL BE INSTALLED IN STRICT ACCORDANCE WITH ALL EXISTING LOCAL, PARISH, STATE AND NATIONAL CODES AND ORDINANCES HAVING JURISDICTION. SUCH CODES INCLUDE, BUT ARE NOT LIMITED TO, IBC, IMC, IFC, NFPA, ETC.. LOCAL CODES SHALL TAKE PRECEDENCE OVER STATE CODES WHICH SHALL TAKE PRECEDENCE OVER NATIONAL CODES AND INDUSTRY STANDARDS.
10. IF ANY CONFLICTS ARE FOUND BETWEEN SPECIFICATIONS AND DRAWINGS AND ABOVE AUTHORITIES, NOTIFY ENGINEER AS SOON AS CONFLICTS ARE DISCOVERED AND ABOVE CODES AND REQUIREMENTS WILL GOVERN.
11. SECURE ALL PERMITS AND INSPECTIONS IF REQUIRED AND PAY ALL FEES, ASSESSMENTS AND TAXES NECESSARY FOR COMPLETION AND ACCEPTANCE OF WORK. NOTIFY ENGINEER AND PROPER AUTHORITIES IN AMPLE TIME WHEN ANY WORK IS READY TO BE INSPECTED OR TESTED.
12. VISIT AND EXAMINE JOB SITE IN ORDER TO BECOME FAMILIAR WITH ALL EXISTING CONDITIONS PERTINENT TO WORK TO BE PERFORMED. NO ADDITIONAL COMPENSATION WILL BE ALLOWED FOR FAILURE TO BE SO INFORMED. DUE TO SMALL SCALE OF DRAWINGS, IT IS NOT POSSIBLE TO SHOW ALL FITTINGS OR OFFSETS OR TO SHOW ALL ACCESSORIES. STACK PIPING AND ACCESSORIES AS REQUIRED FOR FIT AND ACCESS.
13. CONTRACTOR IS RESPONSIBLE FOR ACCURACY OF CLEARANCES AND FOR COORDINATION WITH OTHER TRADES. NO EQUIPMENT, DUCTWORK, PIPING, ETC. SHALL BE FABRICATED OR INSTALLED WITHOUT FULL COORDINATION. MAKE ALLOWANCE IN BID FOR JOB CONDITIONS AND INTERFERENCES WHICH WILL REQUIRE OFFSETS IN DUCTWORK, PIPING, ETC.
14. CONTRACTOR SHALL REMOVE AND RELOCATE, WITHOUT ADDITIONAL COMPENSATION, ANY ITEM THAT IS INSTALLED WITHOUT REQUIRED COORDINATION AND IS FOUND TO BE IN CONFLICT WITH OTHER TRADES. IF FIELD MEASUREMENTS SHOW THAT EQUIPMENT, DUCTWORK, ETC. CANNOT FIT IN THE ALLOTTED SPACE; IT SHALL BE BROUGHT TO THE ATTENTION OF THE ENGINEER PRIOR TO ORDERING OR INSTALLING THE EQUIPMENT.
15. REVIEW OF PRODUCT SUBMITTALS DOES NOT RELIEVE THE CONTRACTOR OF RESPONSIBILITY FOR COMPLIANCE WITH THE CONTRACT DOCUMENTS FOR SYSTEM CAPACITIES OR FOR FITTING THE EQUIPMENT IN THE ALLOTTED SPACE. REVIEW IS FOR GENERAL COMPLIANCE WITH THE CONTRACT DOCUMENTS.
16. ALL EQUIPMENT SHALL BE PURCHASED FROM AUTHORIZED FACTORY REPRESENTATIVE WITH ESTABLISHED OFFICE IN LOCAL AREA, IF MANUFACTURER HAS SUCH AN OFFICE.
17. SUBSTITUTIONS MUST BE REQUESTED IN CONFORMANCE WITH REQUIREMENTS STATED IN THE SUPPLEMENTARY GENERAL CONDITIONS.
18. SUPPORT ALL PIPING INDEPENDENTLY OF ALL EQUIPMENT AND ARRANGE HANGERS TO ISOLATE ANY VIBRATION TRANSMISSION FROM PIPING TO STRUCTURE.
19. INSTALL ALL PIPING SO THAT IT MAY EXPAND AND CONTRACT FREELY WITHOUT DAMAGE TO EQUIPMENT, OTHER WORK OR INJURY TO PIPING SYSTEM. SUPPORT PIPING INDEPENDENTLY OF ALL EQUIPMENT.
20. INSTALL UNIONS ADJACENT TO ALL SCREWED COCKS, CONTROL VALVES, DISCHARGE FROM RELIEF VALVES. FLANGED FITTINGS ARE CONSIDERED EQUIVALENT TO UNION CONNECTIONS.
21. ALL POWER WIRING SHALL BE INSTALLED IN ACCORDANCE WITH NFPA 70.
22. PRIOR TO THE FINAL RELEASE FOR MANUFACTURE OR SHIPMENT OF ANY EQUIPMENT, IT SHALL BE THE RESPONSIBILITY OF THE MECHANICAL CONTRACTOR TO VERIFY THE AVAILABLE ELECTRICAL SERVICE FOR EACH PIECE OF EQUIPMENT WITH THE CONTRACTOR AND TO PROVIDE EQUIPMENT THAT SUITS THE AVAILABLE SERVICE.
23. ANY EQUIPMENT DELIVERED TO THE SITE WITH INCORRECT VOLTAGE OR PHASE SHALL BE REPLACED AT THE CONTRACTOR'S EXPENSE.
24. PIPING TO BE FREE OF ALL OBSTRUCTIONS. REMOVE ALL DEBRIS, SURPLUS AND WASTE MATERIALS COMPLETELY FROM THE JOB SITE.
25. PROPERLY OIL, GREASE AND LUBRICATE ALL MOTORS BEFORE STARTING AND UNTIL FINAL ACCEPTANCE OF WORK.

26. FURNISH TO OWNER THREE COMPLETE SETS OF PARTS CATALOGS AND OPERATING INSTRUCTIONS BOUND IN LARGE 3-RING BINDERS FOR USE OF MAINTENANCE DEPARTMENT. INCLUDE INFORMATION FOR ALL EQUIPMENT SUBMITTED TO THE ENGINEER.
27. MANUFACTURER WARRANTIES FOR ALL EQUIPMENT FURNISHED ON THE PROJECT SHALL RUN FOR A PERIOD OF ONE YEAR FROM DATE OF "SUBSTANTIAL COMPLETION. DURING WARRANTY, CORRECT ANY DEFECTS IN NEW EQUIPMENT, MATERIALS OR WORKMANSHIP, WITHOUT COST TO OWNER FOR EITHER PARTS OR LABOR.
28. A COMPETENT AND EXPERIENCED SERVICE AND INSTALLATION MECHANIC SHALL BE EMPLOYED BY THE CONTRACTOR TO START AND ADJUST ALL EQUIPMENT. THE ENGINEER RESERVES THE RIGHT TO REQUIRE THE TEST OF ANY ITEM OF EQUIPMENT OR MACHINERY. SUCH TESTS SHALL BE CONDUCTED BY THE CONTRACTOR IN THE PRESENCE OF THE ENGINEER OR HIS AUTHORIZED REPRESENTATIVE.
29. AS CONSTRUCTION PROGRESSES, TEST PIPING AND EQUIPMENT TO PRESSURE HEREINAFTER SPECIFIED. WHERE PRESSURES ARE NOT MENTIONED, TEST TO ONE AND ONE HALF TIMES SERVICE CONDITIONS BEFORE CONCEALING OR INSULATING.
30. FLUSH ALL SYSTEMS UNTIL CLEAR WATER FLOWS OR AS HEREINAFTER SPECIFIED.
31. FURNISH ALL NECESSARY GAUGES, INSTRUMENTS, TEST PLUGS AND TEMPORARY CONNECTIONS. TEST ALL EQUIPMENT UNDER SERVICE CONDITIONS AND MAKE ALL NECESSARY ADJUSTMENTS TO CONTROLS, DAMPERS, VALVES, ETC., TO OBTAIN BEST OPERATION. MAKE INITIAL TESTS WITH BUILDING UNOCCUPIED AND FINAL TESTS UNDER ACTUAL HEATING AND COOLING CONDITIONS.
32. GUARANTEE ALL INSTALLATIONS AGAINST ALL DEFECTS IN EQUIPMENT, MATERIALS AND WORKMANSHIP FOR A PERIOD OF ONE YEAR FROM DATE OF "SUBSTANTIAL COMPLETION". DURING GUARANTEE PERIOD, CORRECT ANY DEFECTS IN NEW EQUIPMENT, MATERIALS OR WORKMANSHIP, WITHOUT COST TO OWNER FOR EITHER PARTS OR LABOR.
33. CONTRACTOR'S GUARANTEE INCLUDES PERFORMANCE CAPACITIES AND RATINGS AS SPECIFIED.
34. CONTRACTOR SHALL PROVIDE A SET OF AS-BUILTS WHICH SHALL BE MARKED UP BY CONTRACTOR AS WORK PROGRESSES TO REFLECT ALL ITEMS OF INSTALLATION WHICH DIFFER SIGNIFICANTLY FROM WORK SHOWN ON CONTRACT DRAWINGS. ASBUILT DRAWINGS SHALL BE NEATLY DONE, NOT SKETCHY OR FREE HAND. FINAL PAYMENT WILL BE WITHHELD UNTIL DRAWINGS ARE FURNISHED.
35. FOR ANY POINTS WHICH ARE NOT CLEAR, OR FOR ITEMS AND/OR DETAILS WHICH CONTRACTOR FEELS ARE IN NEED OF CLARIFICATION, CONSULT ENGINEER.
36. IF NO CLARIFICATIONS ARE REQUESTED PRIOR TO THE BID, THE CONTRACTOR, BY SUBMISSION OF HIS BID, INDICATES HE HAS A CLEAR AND FULL UNDERSTANDING OF THE INTENT OF THE PLANS AND SPECIFICATIONS.

PLUMBING NOTES:

1. THE BUILDING DOMESTIC WATER SYSTEM IS ISOLATED FROM CITY WATER SUPPLY BY AN EXISTING REDUCED PRESSURE BACKFLOW PREVENTION DEVICE LOCATED AT THE INCOMING SERVICES. ALL MECHANICAL PIPING SYSTEMS SHALL BE ISOLATED FROM THE BUILDING POTABLE WATER SUPPLY BY AN AIR GAP OR A REDUCED PRESSURE BACKFLOW PREVENTION DEVICE.
2. ALL SHUTOFF VALVES 2 1/2" AND SMALLER SHALL BE RATED 150 PSI SWP AND 600 PSI NON-SHOCK WOG AND WILL HAVE 2-PIECE, CAST BRONZE BODIES, TFE SEATS, FULL PORT, SEPARATE PACKNUT WITH ADJUSTABLE STEM PACKING, ANTI-BLOWOUT STEMS AND CHROME-PLATED BRASS/BRONZE BALL. VALVE ENDS SHALL HAVE EXTENDED SOLDER CONNECTIONS AND BE MANUFACTURED TO COMPLY WITH MSS SP-110. NIBCO S-585-70, OR APPROVED EQUAL.
3. SANITARY PIPING ABOVE GROUND SHALL BE SCH 40 SOLID CORE PVC WITH SOLVENT WELD DRAINAGE WASTE FITTINGS.
4. WATER PIPING ABOVE GROUND SHALL BE TYPE "L" COPPER TUBING WITH WROUGHT SOLDER-JOINT FITTINGS, ANSI B16.22, OR EQUAL, USING 95-5 TIN-ANTIMONY SOLDER. ALL CONNECTIONS BETWEEN STEEL AND COPPER SHALL BE MADE WITH DIELECTRIC UNIONS.
5. POLYPROPYLENE PIPING FOR DOMESTIC WATER SHALL BE ALLOWED WITH APPROVAL BY OWNER. PIPE SHALL BE MANUFACTURED FROM PP-R / PP-RCT RESIN AND SHALL MEET ASTM F-2389, CSA B137.11 AND ANSI 14 REQUIREMENTS. HOT WATER PIPING SHALL CONTAIN A FIBER LAYER. FUSION-WELD ALL JOINTS AND FITTINGS. PIPING SHALL BE INSTALLED AND TESTED PER MANUFACTURER'S RECOMMENDATIONS. APPROVED MANUFACTURERS ARE NIRON AND AQUATHERM.
6. NIPPLE CONNECTIONS AT FIXTURES SHALL BE BRASS OR COPPER PIPE. NO STEEL NIPPLES PERMITTED.
7. DOMESTIC COLD WATER LINES ABOVE GRADE SHALL BE INSULATED WITH 1/2" THICK FIBERGLAS LOW PRESSURE PIPE INSULATION. DOMESTIC HOT WATER AND HOT WATER RETURN LINES ABOVE GRADE SHALL BE INSULATED WITH 1" THICK FIBERGLAS LOW PRESSURE PIPE INSULATION.
8. UNIONS SHALL BE USED ON ALL ITEMS OF EQUIPMENT. ALL UNIONS MUST BE ACCESSIBLE. USE WROUGHT COPPER SOLDER TYPE GROUND JOINT UNIONS UP TO 2" IN SIZE. IN STEEL PIPE, USE BRASS TO IRON SEAT MALLEABLE IRON GROUND JOINT, 150 POUNDS UNIONS OR UNION FITTING GALVANIZED UP TO AND INCLUDING 3" SIZES.
9. INSTALL ONE AIR CHAMBER ON EACH HOT WATER AND EACH COLD WATER PIPE TO EACH PLUMBING FIXTURE OR BEHIND EACH GROUP OF PLUMBING FIXTURES. AIR CHAMBERS SHALL BE CONSTRUCTED FROM COPPER PIPE. IF ONE AIR CHAMBER IS INSTALLED ON EACH COLD WATER PIPE BEHIND A GROUP OF FIXTURES, IT SHALL BE 3" IN DIAMETER, 24" LONG CAPPED. IF ONE AIR CHAMBER IS INSTALLED ON EACH COLD WATER PIPE TO EACH PLUMBING FIXTURE, IT SHALL BE THE FULL SIZE OF THE SUPPLY AND 12" TALL PROPERLY CAPPED.
10. AT THE CONTRACTOR'S OPTION, HE MAY USE FACTORY FABRICATED CHAMBERS WITH A VOLUME AT LEAST EQUAL TO THOSE HEREIN SPECIFIED FOR EACH TYPE OF INSTALLATION, AND AS RECOMMENDED PER THE MANUFACTURER FOR THE INSTALLED FIXTURE UNITS AND IN ACCORDANCE WITH P.D.I. STD. WH. 201. APPROVED MANUFACTURERS ARE JOSAM, WADE, SMITH AND ZURN.
11. EACH PLUMBING FIXTURE SHALL BE FITTED WITH ALL NECESSARY AND PROPER FITTINGS, TRIMMINGS AND OPERATING DEVICES, AND SHALL BE LEFT IN PERFECT OPERATING CONDITION. FINISH OF ALL EXPOSED METAL WORK IN CONNECTION WITH FIXTURES, TRIMMINGS AND OPERATING DEVICES, WHERE NOT SPECIFICALLY MENTIONED, SHALL BE CHROMIUM PLATE FINISH. PROVIDE PROPER BACKING OR CARRIERS FOR FIXTURES AS REQUIRED FOR SECURE INSTALLATION.
12. ALL PIPING SHALL BE HUNG FROM THE BUILDING STRUCTURE USING PROPERLY SIZED BEAM CLAMPS, INSERTS, ETC. NO PIPING SHALL BE HUNG FROM OTHER PIPING, DUCTWORK, EQUIPMENT, ETC.
13. THE WATER SYSTEM SHALL BE INSTALLED WITH THE FALL TOWARD THE SHUTOFF VALVE FOR THE LOWEST FIXTURE. AIR CHAMBERS SHALL BE CONCEALED IN CHASES OR PARTITIONS.
14. ALL HORIZONTAL SOIL AND WASTE PIPES SHALL BE GRADED 1/4" PER FOOT, WHERE POSSIBLE, BUT IN NO CASE LESS THAN 1/8" PER FOOT.

REVISIONS	BY

ARCHITECT/ENGINEER:

ECM Consultants, Inc.

ENGINEERS - ARCHITECTS - CONSTRUCTION MANAGERS
1301 CLEARVIEW PKWY, SUITE 200
METairie, LOUISIANA 70001
PHONE: (504) 885-4080, FAX: (504) 885-1439
EMAIL: mail@ecmconsultants.com

OWNER:

HOUSING AUTHORITY OF NEW ORLEANS

2051 SENATE ST. BUILDING B, RM. 202
NEW ORLEANS, LOUISIANA 70122

REMOVE/REPLACE WATER SOFTENER SYSTEM LOUISIANA NEW ORLEANS

MECHANICAL NOTES & LEGEND

DRAWN
CHECKED
DATE MAY 2, 2023
SCALE AS SHOWN
JOB NO. 22462.10
SHEET NO. M1.0
OF X SHEETS

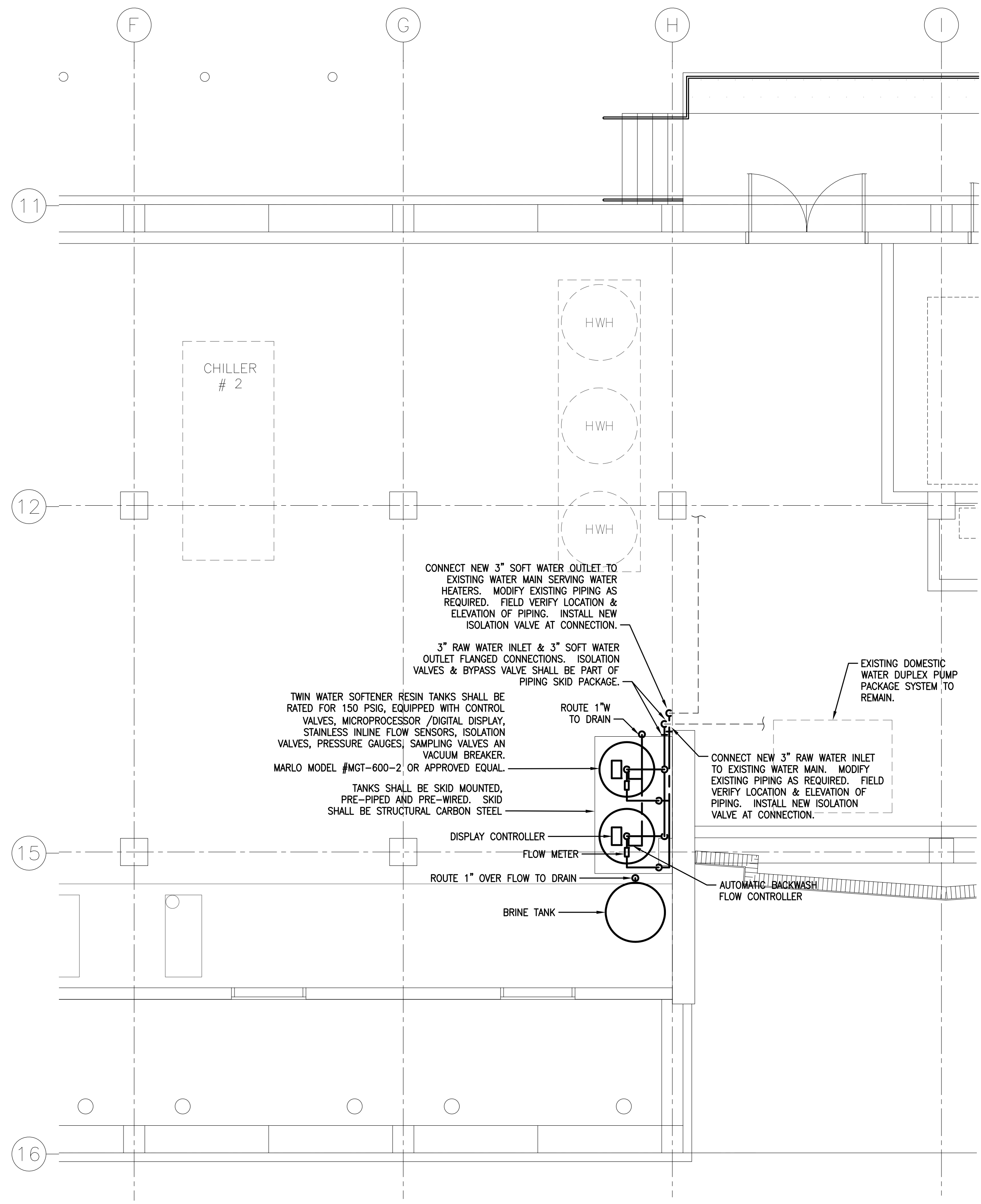

1 ENLARGED MECHANICAL ROOM PLAN
AT WATER TREATMENT AREA SCALE: 1/4" = 1'-0"

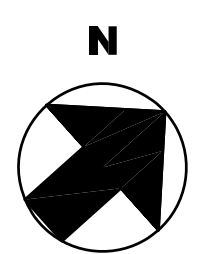

MECHANICAL NOTES:

CONTRACTOR SHALL FIELD VERIFY ROUTING AND SIZING OF ALL EXISTING PIPING PRIOR TO DEMOLITION OF EXISTING AND AND FABRICATION/INSTALLATION OF NEW PIPING.

REUSE EXISTING VALVES WHERE POSSIBLE. CONTRACTOR SHALL BRING TO THE ENGINEER'S ATTENTION ANY VALVES THAT NEED TO BE REPLACED.

CONNECT WATER TREATMENT TO EXISTING POWER SOURCE.

MECHANICAL LEGEND

- INDICATES DRAIN PIPING (PIPING TO BE TYPE 'L' COPPER WITH COPPER SWEAT FITTINGS)
- SOIL & WASTE PIPING
- |— VENT PIPING
- - - COLD WATER PIPING
- - - HOT WATER PIPING
- BALL VALVE
- || BUTTERFLY VALVE
- ∇ CHECK VALVE
- ⊗ TIE-IN POINT CONNECTION

REVISIONS	BY

ARCHITECT/ENGINEER:
ECM Consultants, Inc.
ENGINEERS - ARCHITECTS - CONSTRUCTION MANAGERS
1301 CLEARVIEW PKWY, SUITE 200
METairie, LOUISIANA 70001
PHONE: (504) 885-4080, FAX: (504) 885-1439
EMAIL: mail@ecmconsultants.com

OWNER:
HOUSING AUTHORITY OF NEW ORLEANS
2051 SENATE ST. BUILDING B, RM. 202
NEW ORLEANS, LOUISIANA 70122

GUSTE HIGH-RISE REMOVE/REPLACE WATER SOFTENER SYSTEM NEW ORLEANS LOUISIANA

ENLARGED GROUND FLOOR PLAN AT WATER SOFTENER AREA

DRAWN
CHECKED
DATE MAY 2, 2023
SCALE AS SHOWN
JOB NO. 22462.10
SHEET NO. M1.1
OF X SHEETS



1 EXISTING WATER SOFTENER SYSTEM
SCALE: NTS

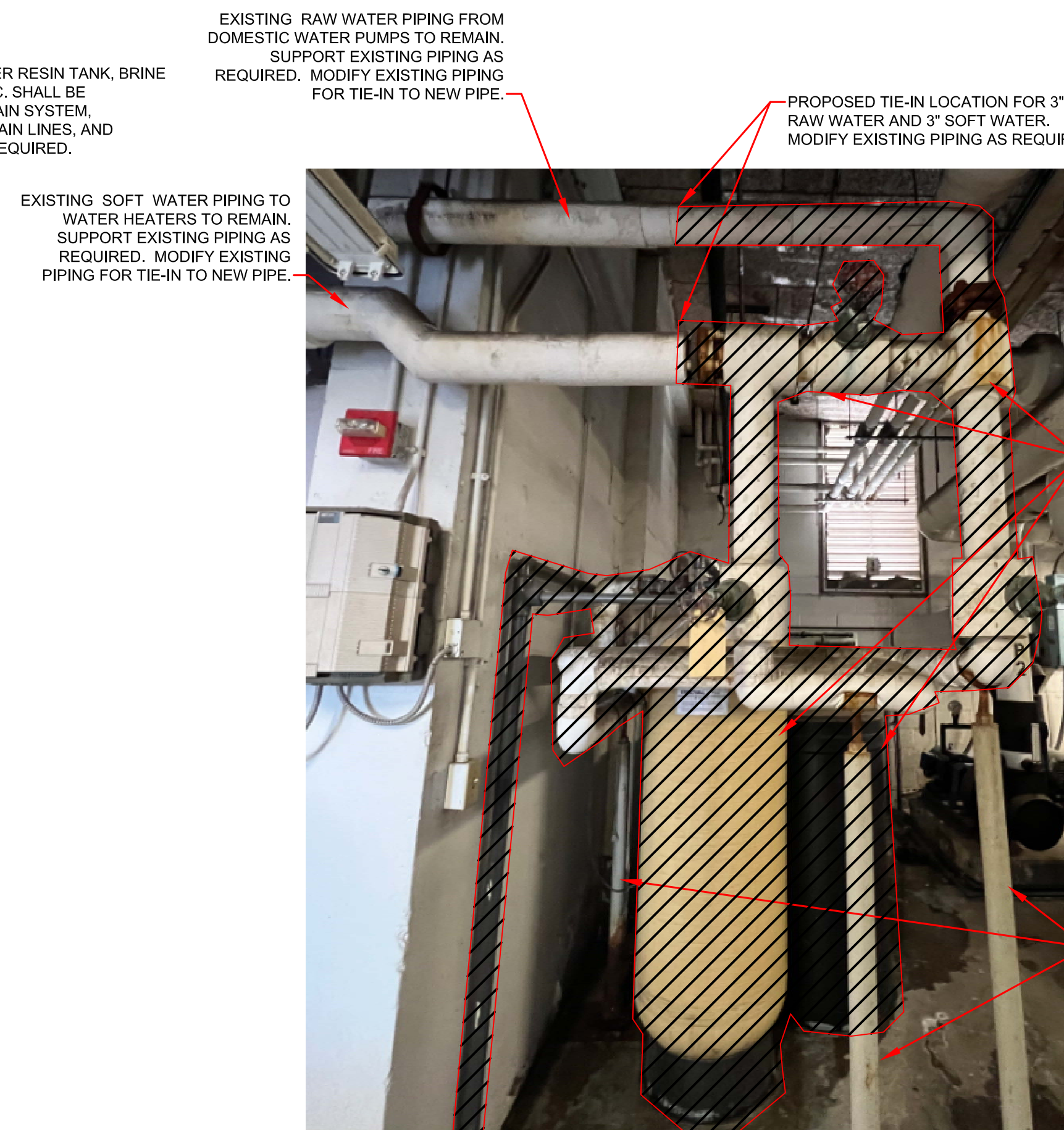

2 EXISTING WATER SOFTENER SYSTEM
SCALE: NTS

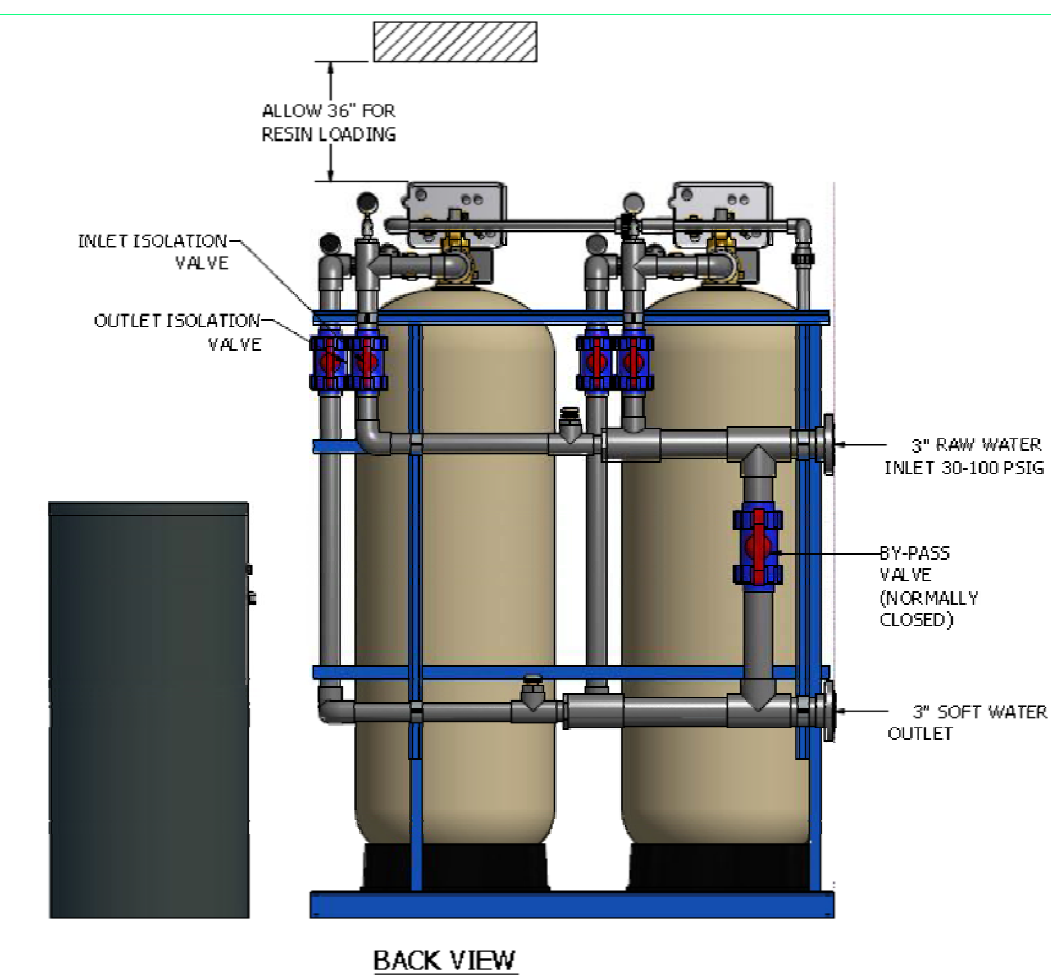
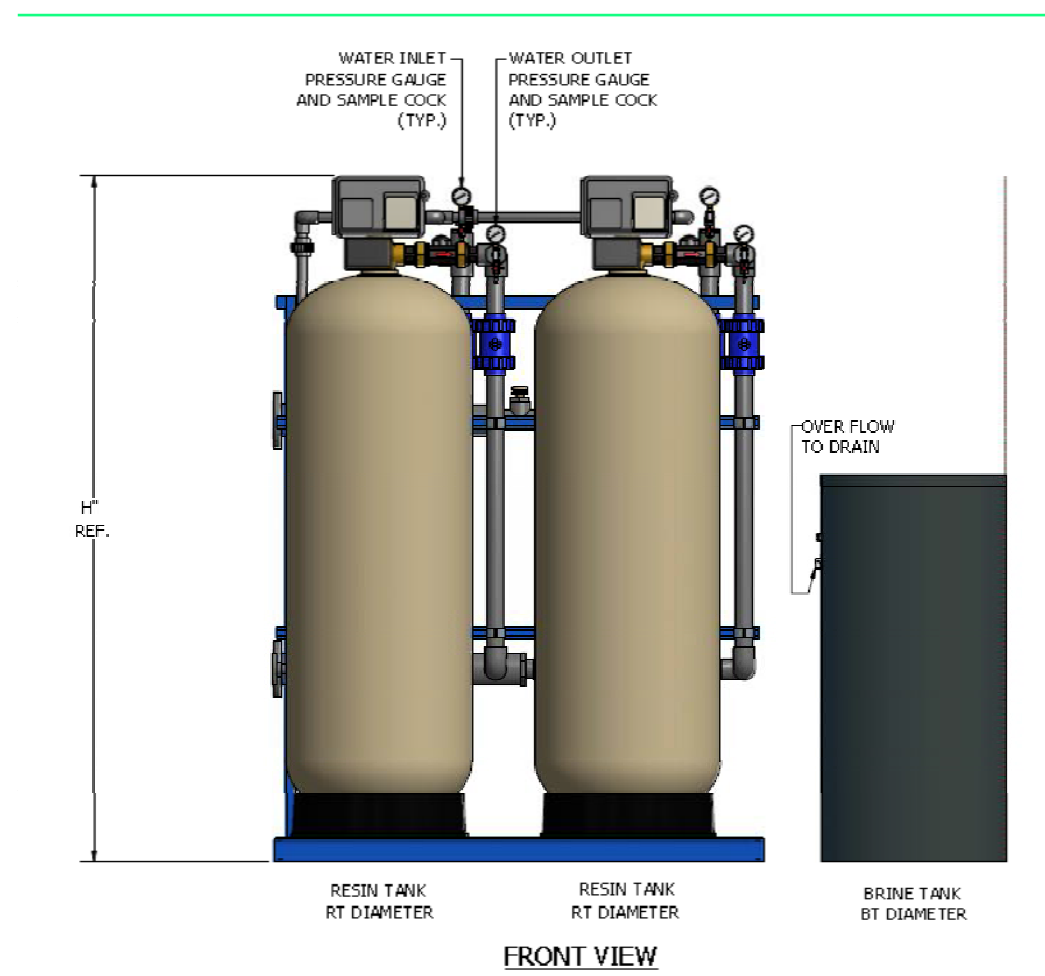

3 MARLO MODEL # MGT-600-2
(OR EQUAL)
SCALE: NTS

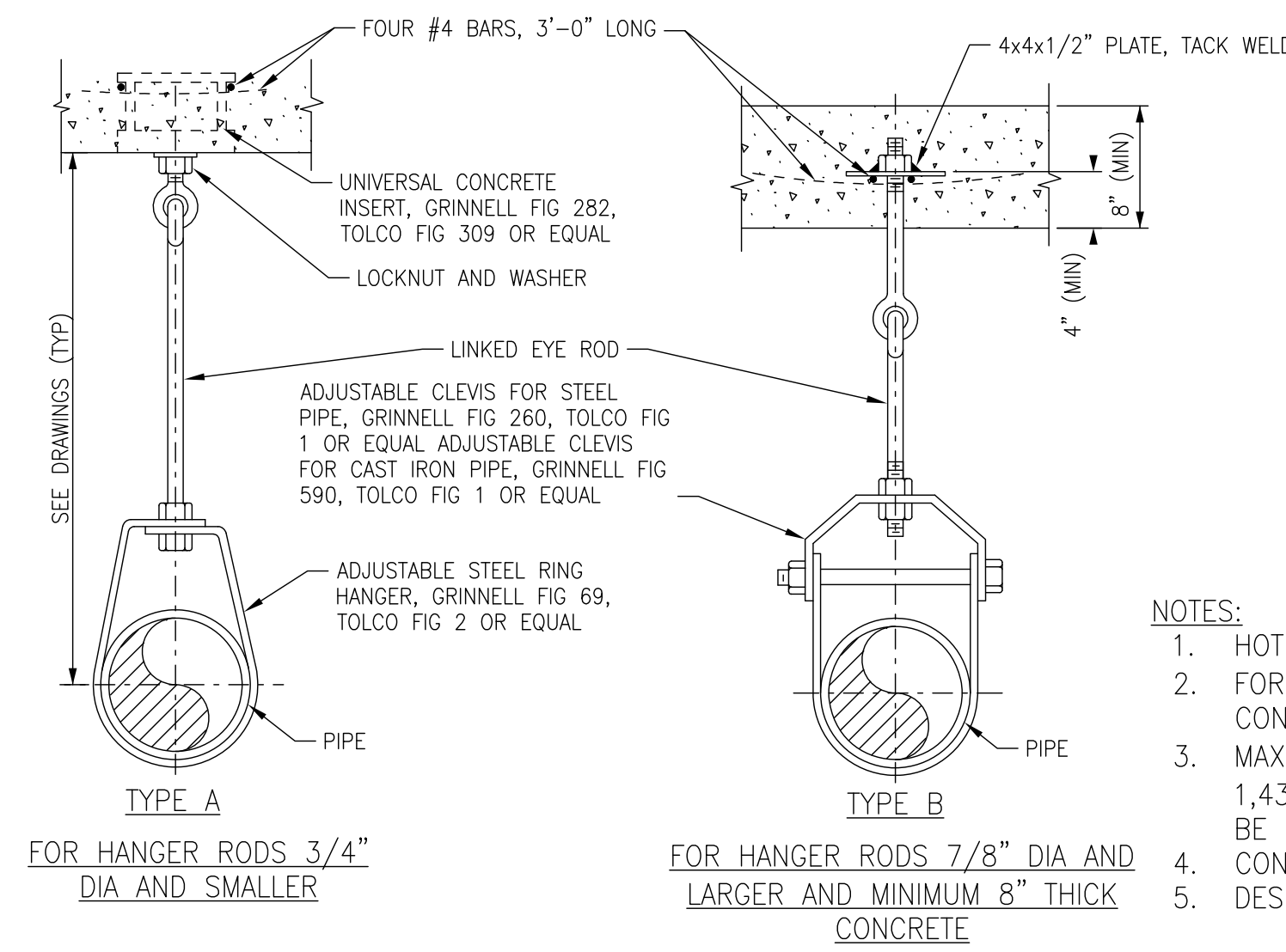

NOMINAL PIPE DIAMETER (INCHES)	ROD DIAMETER (INCHES)	MAX SUPPORT SPACING (FEET)		WEIGHT LIMIT (LBS)	
		STEEL PIPE	DI PIPE	TYPE A	TYPE B
1 & SMALLER	3/8	6	10	300	610
1 1/4 TO 2	3/8	10	10	300	610
2 1/2 TO 3 1/2	1/2	12	10	525	1130
4 TO 5	5/8	14	10	650	1430
6 TO 8	3/4	17	10	1000	1940
10 TO 12	7/8	18	10	1430	3600

- NOTES:
- HOT DIP GALVANIZE PARTS AFTER FABRICATION
 - FOR PIPES 2" DIAMETER AND SMALLER, EYE BOLT IN CONCRETE ANCHORS MAY BE USED
 - MAXIMUM LOAD FOR CONCRETE INSERT (TYPE A) SHALL BE 1,430 LBS AND FOR 4" SQ BEARING PLATE (TYPE B) SHALL BE 3,600 LBS.
 - CONCRETE STRENGTH SHALL BE 3000 PSI MINIMUM
 - DESIGN IS FOR STATIC LOAD ONLY

PIPE HANGER
NTS

REVISIONS	BY

ARCHITECT/ENGINEER:
ECM Consultants, Inc.
ENGINEERS - ARCHITECTS - CONSTRUCTION MANAGERS
1301 CLEARVIEW PKWY, SUITE 200
METairie, LOUISIANA, 70001
PHONE: (504) 885-4080, FAX: (504) 885-1439
EMAIL: mail@ecmconsultants.com

OWNER:
HOUSING AUTHORITY OF NEW ORLEANS
2051 SENATE ST. BUILDING B, RM. 202
NEW ORLEANS, LOUISIANA 70122

GUSTE HIGH-RISE REMOVE/REPLACE WATER SOFTENER SYSTEM NEW ORLEANS
EXISTING BOILERS DEMOLITION

DRAWN
CHECKED
DATE MAY 2, 2023
SCALE AS SHOWN
JOB NO. 22462.XX
SHEET NO. M1.2
OF X SHEETS

INVITATION FOR BIDS (IFB) No. 23-912-41 Water Softener System for Guste High Rise

“NO BID” RESPONSE FORM

If you do not wish to bid/submit a bid on this solicitation, please provide written notification of your decision. Your responses assist with planning future solicitations. Please indicate below in the appropriate area the reason(s) for your decision and return this page. Responses do not prohibit you from receiving future opportunities unless you request to be removed from future communications. This form may be returned to the address listed below, emailed to procurement@hano.org, or faxed to 504-286-8224.

Check all that apply:

- I am submitting a “No Bid” at this time.
Please keep my name on the Agency’s Bidder’s List.
 - Too busy at this time
 - Job too small
 - Job too large
 - Territory too large to cover
 - Cannot meet delivery requirements
 - I cannot meet the Terms and Conditions of the solicitation because:
 - I do not provide products/services of this nature.
 - Insufficient time to respond to solicitation
 - Unable to meet bond/insurance requirements
 - Specifications too restrictive. Please explain:

 - Specifications unclear. Please explain:

 - Other: _____
- Please remove my name from this product/service category. I wish to submit a revised Vendor Registration Form. You may receive a copy by email by contacting Procurement at procurement@hano.org.
- I no longer wish to do business with Housing Authority of New Orleans. Please remove my name from the Agency’s Source List(s).

Name of Company

Date

Printed Name of Authorized Representative

Phone Number

Signature of Authorized Representative

Email

Please return this completed form to:
Housing Authority of New Orleans
Procurement & Contracts Department
4100 Touro St.
New Orleans, LA 70122
Email: procurement@hano.org Fax: 504-286-8224

IFB Attachment A (Form of Bid)



INVITATION FOR BIDS (IFB) No. 23-912-41 Water Softener System for Guste High Rise

FORM OF BID
(ATTACHMENT A)

(This Form must be fully completed and included in the “hard copy” bid submittal.)

Instructions: Unless otherwise specifically required, the items listed below must be completed and included in the bid submittal. Please complete this form by marking an “X,” where provided, to verify that the referenced completed form or information has been included within the “hard copy” bid submittal submitted by the bidder. Also, complete the Section 3 Statement and the Bidder’s Statement as noted below:

X=ITEM INCLUDED	SUBMITTAL ITEMS <i>(One original and Three copies of each bid, including one with original signatures)</i>
_____	1 Form of Bid (Attachment A)
_____	2 Form HUD-5369-A (Attachment E)
_____	3 Form SF-LLL (Disclosure of Lobbying Activities (Attachment B-1)
_____	4 Form HUD-50071 (Certification of Payments to Influence Federal Transactions (Attachment B-2)
_____	5 Form HUD-50070 - (Certification of a Drug-Free Workplace (Attachment B-3)
_____	6 Profile of Firm Form (Attachment C)
_____	7 Entry of Proposed Fees (Louisiana Uniform Public Work Bid Form (Attachment I)
_____	8 Acknowledgment of Addenda
_____	9 Equal Employment Opportunity Policy/Statement
_____	10 Certification of Contractor Non-Exclusion
_____	11 Subcontractor/Joint Venture Information
_____	12 Section 3 Business Preference Documentation
_____	13 Statement of Bidder’s Qualifications (Attachment P)
_____	14 Vendor Registration Form (Attachment L)
_____	15 Corporate Resolution (Attachment R)

SECTION 3 STATEMENT

Are you claiming a Section 3 business preference? YES_or NO_. If “YES,” pursuant to the Section 3 portion within the Conditions and Specifications, and pursuant to the documentation justifying such, which priority are you claiming? _____.

BIDDER’S STATEMENT

The undersigned bidder hereby states that by completing and submitting this Form and all other documents within this bid submittal, he/she is verifying that all information provided herein is, to the best of his/her knowledge, true and accurate, and that if the HA discovers that any information entered herein to be false, such shall entitle the HA to not consider or make award or to cancel any award with the undersigned party. Further, by completing and submitting the bid submittal, and by entering and submitting the costs where provided within the noted Internet System, the undersigned bidder is thereby agreeing to abide by all terms and conditions pertaining to this IFB as issued by the HA, either in hard copy or on the noted Internet System, including an agreement to execute the attached Sample Contract form. Pursuant to all IFB Documents, this Form of Bid, and all attachments, and pursuant to all completed Documents submitted, including these forms and all attachments, the undersigned proposes to supply the HA with the services described herein for the fee(s) entered within the areas provided within the noted Internet System pertaining to this IFB.

Signature Date Printed Name Company

Attachment B

HUD-5369



**U.S. Department of Housing and
Urban Development**
Office of Public and Indian Housing

**Instructions to Bidders for Contracts
Public and Indian Housing Programs**

Instructions to Bidders for Contracts

Public and Indian Housing Programs

Table of Contents

Clause	Page
1. Bid Preparation and Submission	1
2. Explanations and Interpretations to Prospective Bidders	1
3. Amendments to Invitations for Bids	1
4. Responsibility of Prospective Contractor	1
5. Late Submissions, Modifications, and Withdrawal of Bids	1
6. Bid Opening	2
7. Service of Protest	2
8. Contract Award	2
9. Bid Guarantee	3
10. Assurance of Completion	3
11. Preconstruction Conference	3
12. Indian Preference Requirements	3

1. Bid Preparation and Submission

(a) Bidders are expected to examine the specifications, drawings, all instructions, and, if applicable, the construction site (see also the contract clause entitled **Site Investigation and Conditions Affecting the Work** of the *General Conditions of the Contract for Construction*). Failure to do so will be at the bidders' risk.

(b) All bids must be submitted on the forms provided by the Public Housing Agency/Indian Housing Authority (PHA/IHA). Bidders shall furnish all the information required by the solicitation. Bids must be signed and the bidder's name typed or printed on the bid sheet and each continuation sheet which requires the entry of information by the bidder. Erasures or other changes must be initialed by the person signing the bid. Bids signed by an agent shall be accompanied by evidence of that agent's authority. (Bidders should retain a copy of their bid for their records.)

(c) Bidders must submit as part of their bid a completed form HUD-5369-A, "Representations, Certifications, and Other Statements of Bidders."

(d) All bid documents shall be sealed in an envelope which shall be clearly marked with the words "Bid Documents," the Invitation for Bids (IFB) number, any project or other identifying number, the bidder's name, and the date and time for receipt of bids.

(e) If this solicitation requires bidding on all items, failure to do so will disqualify the bid. If bidding on all items is not required, bidders should insert the words "No Bid" in the space provided for any item on which no price is submitted.

(f) Unless expressly authorized elsewhere in this solicitation, alternate bids will not be considered.

(g) Unless expressly authorized elsewhere in this solicitation, bids submitted by telegraph or facsimile (fax) machines will not be considered.

(h) If the proposed contract is for a Mutual Help project (as described in 24 CFR Part 905, Subpart E) that involves Mutual Help contributions of work, material, or equipment, supplemental information regarding the bid advertisement is provided as an attachment to this solicitation.

2. Explanations and Interpretations to Prospective Bidders

(a) Any prospective bidder desiring an explanation or interpretation of the solicitation, specifications, drawings, etc., must request it at least 7 days before the scheduled time for bid opening. Requests may be oral or written. Oral requests must be confirmed in writing. The only oral clarifications that will be provided will be those clearly related to solicitation procedures, i.e., not substantive technical information. No other oral explanation or interpretation will be provided. Any information given a prospective bidder concerning this solicitation will be furnished promptly to all other prospective bidders as a written amendment to the solicitation, if that information is necessary in submitting bids, or if the lack of it would be prejudicial to other prospective bidders.

(b) Any information obtained by, or provided to, a bidder other than by formal amendment to the solicitation shall not constitute a change to the solicitation.

3. Amendments to Invitations for Bids

(a) If this solicitation is amended, then all terms and conditions which are not modified remain unchanged.

(b) Bidders shall acknowledge receipt of any amendment to this solicitation (1) by signing and returning the amendment, (2) by identifying the amendment number and date on the bid form, or (3) by letter, telegram, or facsimile, if those methods are authorized in the solicitation. The PHA/IHA must receive acknowledgement by the time and at the place specified for receipt of bids. Bids which fail to acknowledge the bidder's receipt of any amendment will result in the rejection of the bid if the amendment(s) contained information which substantively changed the PHA's/IHA's requirements.

(c) Amendments will be on file in the offices of the PHA/IHA and the Architect at least 7 days before bid opening.

4. Responsibility of Prospective Contractor

(a) The PHA/IHA will award contracts only to responsible prospective contractors who have the ability to perform successfully under the terms and conditions of the proposed contract. In determining the responsibility of a bidder, the PHA/IHA will consider such matters as the bidder's:

- (1) Integrity;
- (2) Compliance with public policy;
- (3) Record of past performance; and
- (4) Financial and technical resources (including construction and technical equipment).

(b) Before a bid is considered for award, the bidder may be requested by the PHA/IHA to submit a statement or other documentation regarding any of the items in paragraph (a) above. Failure by the bidder to provide such additional information shall render the bidder nonresponsible and ineligible for award.

5. Late Submissions, Modifications, and Withdrawal of Bids

(a) Any bid received at the place designated in the solicitation after the exact time specified for receipt will not be considered unless it is received before award is made and it:

(1) Was sent by registered or certified mail not later than the fifth calendar day before the date specified for receipt of offers (e.g., an offer submitted in response to a solicitation requiring receipt of offers by the 20th of the month must have been mailed by the 15th);

(2) Was sent by mail, or if authorized by the solicitation, was sent by telegram or via facsimile, and it is determined by the PHA/IHA that the late receipt was due solely to mishandling by the PHA/IHA after receipt at the PHA/IHA; or

(3) Was sent by U.S. Postal Service Express Mail Next Day Service - Post Office to Addressee, not later than 5:00 p.m. at the place of mailing two working days prior to the date specified for receipt of proposals. The term "working days" excludes weekends and observed holidays.

(b) Any modification or withdrawal of a bid is subject to the same conditions as in paragraph (a) of this provision.

(c) The only acceptable evidence to establish the date of mailing of a late bid, modification, or withdrawal sent either by registered or certified mail is the U.S. or Canadian Postal Service postmark both on the envelope or wrapper and on the original receipt from the U.S. or Canadian Postal Service. Both postmarks must show a legible date or the bid, modification, or withdrawal shall be processed as if mailed late. "Postmark" means a printed, stamped, or otherwise placed impression (exclusive of a postage meter machine impression) that is readily identifiable without further action as having been supplied and affixed by employees of the U.S. or Canadian Postal Service on the date of mailing. Therefore, bidders should request the postal clerk to place a hand cancellation bull's-eye postmark on both the receipt and the envelope or wrapper.

(d) The only acceptable evidence to establish the time of receipt at the PHA/IHA is the time/date stamp of PHA/IHA on the proposal wrapper or other documentary evidence of receipt maintained by the PHA/IHA.

(e) The only acceptable evidence to establish the date of mailing of a late bid, modification, or withdrawal sent by Express Mail Next Day Service-Post Office to Addressee is the date entered by the post office receiving clerk on the "Express Mail Next Day Service-Post Office to Addressee" label and the postmark on both the envelope or wrapper and on the original receipt from the U.S. Postal Service. "Postmark" has the same meaning as defined in paragraph (c) of this provision, excluding postmarks of the Canadian Postal Service. Therefore, bidders should request the postal clerk to place a legible hand cancellation bull's eye postmark on both the receipt and Failure by a bidder to acknowledge receipt of the envelope or wrapper.

(f) Notwithstanding paragraph (a) of this provision, a late modification of an otherwise successful bid that makes its terms more favorable to the PHA/IHA will be considered at any time it is received and may be accepted.

(g) Bids may be withdrawn by written notice, or if authorized by this solicitation, by telegram (including mailgram) or facsimile machine transmission received at any time before the exact time set for opening of bids; provided that written confirmation of telegraphic or facsimile withdrawals over the signature of the bidder is mailed and postmarked prior to the specified bid opening time. A bid may be withdrawn in person by a bidder or its authorized representative if, before the exact time set for opening of bids, the identity of the person requesting withdrawal is established and the person signs a receipt for the bid.

6. Bid Opening

All bids received by the date and time of receipt specified in the solicitation will be publicly opened and read. The time and place of opening will be as specified in the solicitation. Bidders and other interested persons may be present.

7. Service of Protest

(a) Definitions. As used in this provision:

"Interested party" means an actual or prospective bidder whose direct economic interest would be affected by the award of the contract.

"Protest" means a written objection by an interested party to this solicitation or to a proposed or actual award of a contract pursuant to this solicitation.

(b) Protests shall be served on the Contracting Officer by obtaining written and dated acknowledgement from —

[Contracting Officer designate the official or location where a protest may be served on the Contracting Officer]

(c) All protests shall be resolved in accordance with the PHA's/IHA's protest policy and procedures, copies of which are maintained at the PHA/IHA.

8. Contract Award

(a) The PHA/IHA will evaluate bids in response to this solicitation without discussions and will award a contract to the responsible bidder whose bid, conforming to the solicitation, will be most advantageous to the PHA/IHA considering only price and any price-related factors specified in the solicitation.

(b) If the apparent low bid received in response to this solicitation exceeds the PHA's/IHA's available funding for the proposed contract work, the PHA/IHA may either accept separately priced items (see 8(e) below) or use the following procedure to determine contract award. The PHA/IHA shall apply in turn to each bid (proceeding in order from the apparent low bid to the high bid) each of the separately priced bid deductible items, if any, in their priority order set forth in this solicitation. If upon the application of the first deductible item to all initial bids, a new low bid is within the PHA's/IHA's available funding, then award shall be made to that bidder. If no bid is within the available funding amount, then the PHA/IHA shall apply the second deductible item. The PHA/IHA shall continue this process until an evaluated low bid, if any, is within the PHA's/IHA's available funding. If upon the application of all deductibles, no bid is within the PHA's/IHA's available funding, or if the solicitation does not request separately priced deductibles, the PHA/IHA shall follow its written policy and procedures in making any award under this solicitation.

(c) In the case of tie low bids, award shall be made in accordance with the PHA's/IHA's written policy and procedures.

(d) The PHA/IHA may reject any and all bids, accept other than the lowest bid (e.g., the apparent low bid is unreasonably low), and waive informalities or minor irregularities in bids received, in accordance with the PHA's/IHA's written policy and procedures.

(e) Unless precluded elsewhere in the solicitation, the PHA/IHA may accept any item or combination of items bid.

(f) The PHA/IHA may reject any bid as nonresponsive if it is materially unbalanced as to the prices for the various items of work to be performed. A bid is materially unbalanced when it is based on prices significantly less than cost for some work and prices which are significantly overstated for other work.

(g) A written award shall be furnished to the successful bidder within the period for acceptance specified in the bid and shall result in a binding contract without further action by either party.

9. Bid Guarantee (applicable to construction and equipment contracts exceeding \$25,000)

All bids must be accompanied by a negotiable bid guarantee which shall not be less than five percent (5%) of the amount of the bid. The bid guarantee may be a certified check, bank draft, U.S. Government Bonds at par value, or a bid bond secured by a surety company acceptable to the U.S. Government and authorized to do business in the state where the work is to be performed. In the case where the work under the contract will be performed on an Indian reservation area, the bid guarantee may also be an irrevocable Letter of Credit (see provision 10, Assurance of Completion, below). Certified checks and bank drafts must be made payable to the order of the PHA/IHA. The bid guarantee shall insure the execution of the contract and the furnishing of a method of assurance of completion by the successful bidder as required by the solicitation. Failure to submit a bid guarantee with the bid shall result in the rejection of the bid. Bid guarantees submitted by unsuccessful bidders will be returned as soon as practicable after bid opening.

10. Assurance of Completion

(a) Unless otherwise provided in State law, the successful bidder shall furnish an assurance of completion prior to the execution of any contract under this solicitation. This assurance may be [Contracting Officer check applicable items] —

[] (1) a performance and payment bond in a penal sum of 100 percent of the contract price; or, as may be required or permitted by State law;

[] (2) separate performance and payment bonds, each for 50 percent or more of the contract price;

[] (3) a 20 percent cash escrow;

[] (4) a 25 percent irrevocable letter of credit; or,

[] (5) an irrevocable letter of credit for 10 percent of the total contract price with a monitoring and disbursements agreement with the IHA (applicable only to contracts awarded by an IHA under the Indian Housing Program).

(b) Bonds must be obtained from guarantee or surety companies acceptable to the U.S. Government and authorized to do business in the state where the work is to be performed. Individual sureties will not be considered. U.S. Treasury Circular Number 570, published annually in the Federal Register, lists companies approved to act as sureties on bonds securing Government contracts, the maximum underwriting limits on each contract bonded, and the States in which the company is licensed to do business. Use of companies listed in this circular is mandatory. Copies of the circular may be downloaded on the U.S. Department of Treasury website <http://www.fms.treas.gov/c570/index.html>, or ordered for a minimum fee by contacting the Government Printing Office at (202) 512-2168.

(c) Each bond shall clearly state the rate of premium and the total amount of premium charged. The current power of attorney for the person who signs for the surety company must be attached to the bond. The effective date of the power of attorney shall not precede the date of the bond. The effective date of the bond shall be on or after the execution date of the contract.

(d) Failure by the successful bidder to obtain the required assurance of completion within the time specified, or within such extended period as the PHA/IHA may grant based upon reasons determined adequate by the PHA/IHA, shall render the bidder ineligible for award. The PHA/IHA may then either award the contract to the next lowest responsible bidder or solicit new bids. The PHA/IHA may retain the ineligible bidder's bid guarantee.

11. Preconstruction Conference (applicable to construction contracts)

After award of a contract under this solicitation and prior to the start of work, the successful bidder will be required to attend a preconstruction conference with representatives of the PHA/IHA and its architect/engineer, and other interested parties convened by the PHA/IHA. The conference will serve to acquaint the participants with the general plan of the construction operation and all other requirements of the contract (e.g., Equal Employment Opportunity, Labor Standards). The PHA/IHA will provide the successful bidder with the date, time, and place of the conference.

12. Indian Preference Requirements (applicable only if this solicitation is for a contract to be performed on a project for an Indian Housing Authority)

(a) HUD has determined that the contract awarded under this solicitation is subject to the requirements of section 7(b) of the Indian Self-Determination and Education Assistance Act (25 U.S.C. 450e(b)). Section 7(b) requires that any contract or subcontract entered into for the benefit of Indians shall require that, to the greatest extent feasible

(1) Preferences and opportunities for training and employment (other than core crew positions; see paragraph (h) below) in connection with the administration of such contracts or subcontracts be given to qualified "Indians." The Act defines "Indians" to mean persons who are members of an Indian tribe and defines "Indian tribe" to mean any Indian tribe, band, nation, or other organized group or community, including any Alaska Native village or regional or village corporation as defined in or established pursuant to the Alaska Native Claims Settlement Act, which is recognized as eligible for the special programs and services provided by the United States to Indians because of their status as Indians; and,

(2) Preference in the award of contracts or subcontracts in connection with the administration of contracts be given to Indian organizations and to Indian-owned economic enterprises, as defined in section 3 of the Indian Financing Act of 1974 (25 U.S.C. 1452). That Act defines "economic enterprise" to mean any Indian-owned commercial, industrial, or business activity established or organized for the purpose of profit, except that the Indian ownership must constitute not less than 51 percent of the enterprise; "Indian organization" to mean the governing body of any Indian tribe or entity established or recognized by such governing body; "Indian" to mean any person who is a member of any tribe, band, group, pueblo, or community which is recognized by the Federal Government as eligible for services from the Bureau of Indian Affairs and any "Native" as defined in the Alaska Native Claims Settlement Act; and Indian "tribe" to mean any Indian tribe, band, group, pueblo, or community including Native villages and Native groups (including

corporations organized by Kenai, Juneau, Sitka, and Kodiak) as defined in the Alaska Native Claims Settlement Act, which is recognized by the Federal Government as eligible for services from the Bureau of Indian Affairs.

(b) (1) The successful Contractor under this solicitation shall comply with the requirements of this provision in awarding all subcontracts under the contract and in providing training and employment opportunities.

(2) A finding by the IHA that the contractor, either (i) awarded a subcontract without using the procedure required by the IHA, (ii) falsely represented that subcontracts would be awarded to Indian enterprises or organizations; or, (iii) failed to comply with the contractor's employment and training preference bid statement shall be grounds for termination of the contract or for the assessment of penalties or other remedies.

(c) If specified elsewhere in this solicitation, the IHA may restrict the solicitation to qualified Indian-owned enterprises and Indian organizations. If two or more (or a greater number as specified elsewhere in the solicitation) qualified Indian-owned enterprises or organizations submit responsive bids, award shall be made to the qualified enterprise or organization with the lowest responsive bid. If fewer than the minimum required number of qualified Indian-owned enterprises or organizations submit responsive bids, the IHA shall reject all bids and readvertise the solicitation in accordance with paragraph (d) below.

(d) If the IHA prefers not to restrict the solicitation as described in paragraph (c) above, or if after having restricted a solicitation an insufficient number of qualified Indian enterprises or organizations submit bids, the IHA may advertise for bids from non-Indian as well as Indian-owned enterprises and Indian organizations. Award shall be made to the qualified Indian enterprise or organization with the lowest responsive bid if that bid is -

(1) Within the maximum HUD-approved budget amount established for the specific project or activity for which bids are being solicited; and

(2) No more than the percentage specified in 24 CFR 905.175(c) higher than the total bid price of the lowest responsive bid from any qualified bidder. If no responsive bid by a qualified Indian-owned economic enterprise or organization is within the stated range of the total bid price of the lowest responsive bid from any qualified enterprise, award shall be made to the bidder with the lowest bid.

(e) Bidders seeking to qualify for preference in contracting or subcontracting shall submit proof of Indian ownership with their bids. Proof of Indian ownership shall include but not be limited to:

(1) Certification by a tribe or other evidence that the bidder is an Indian. The IHA shall accept the certification of a tribe that an individual is a member.

(2) Evidence such as stock ownership, structure, management, control, financing and salary or profit sharing arrangements of the enterprise.

(f) (1) All bidders must submit with their bids a statement describing how they will provide Indian preference in the award of subcontracts. The specific requirements of that statement and the factors to be used by the IHA in determining the statement's adequacy are included as an attachment to this solicitation. Any bid that fails to include the required statement shall be rejected as nonresponsive. The IHA may require that comparable statements be provided by subcontractors to the successful Contractor, and may require the Contractor to reject any bid or proposal by a subcontractor that fails to include the statement.

(2) Bidders and prospective subcontractors shall submit a certification (supported by credible evidence) to the IHA in any instance where the bidder or subcontractor believes it is infeasible to provide Indian preference in subcontracting. The acceptance or rejection by the IHA of the certification shall be final. Rejection shall disqualify the bid from further consideration.

(g) All bidders must submit with their bids a statement detailing their employment and training opportunities and their plans to provide preference to Indians in implementing the contract; and the number or percentage of Indians anticipated to be employed and trained. Comparable statements from all proposed subcontractors must be submitted. The criteria to be used by the IHA in determining the statement(s)'s adequacy are included as an attachment to this solicitation. Any bid that fails to include the required statement(s), or that includes a statement that does not meet minimum standards required by the IHA shall be rejected as nonresponsive.

(h) Core crew employees. A core crew employee is an individual who is a bona fide employee of the contractor at the time the bid is submitted; or an individual who was not employed by the bidder at the time the bid was submitted, but who is regularly employed by the bidder in a supervisory or other key skilled position when work is available. Bidders shall submit with their bids a list of all core crew employees.

(i) Preference in contracting, subcontracting, employment, and training shall apply not only on-site, on the reservation, or within the IHA's jurisdiction, but also to contracts with firms that operate outside these areas (e.g., employment in modular or manufactured housing construction facilities).

(j) Bidders should contact the IHA to determine if any additional local preference requirements are applicable to this solicitation.

(k) The IHA [] does [] does not [Contracting Officer check applicable box] maintain lists of Indian-owned economic enterprises and Indian organizations by specialty (e.g., plumbing, electrical, foundations), which are available to bidders to assist them in meeting their responsibility to provide preference in connection with the administration of contracts and subcontracts.

Attachment B-1
SF-LLL
Disclosure of
Lobbying
Activities



DISCLOSURE OF LOBBYING ACTIVITIES

Complete this form to disclose lobbying activities pursuant to 31 U.S.C. 1352

Approved by OMB

0348-0046

(See reverse for public burden disclosure.)

1. Type of Federal Action: <input type="checkbox"/> a. contract <input type="checkbox"/> b. grant <input type="checkbox"/> c. cooperative agreement <input type="checkbox"/> d. loan <input type="checkbox"/> e. loan guarantee <input type="checkbox"/> f. loan insurance	2. Status of Federal Action: <input type="checkbox"/> a. bid/offer/application <input type="checkbox"/> b. initial award <input type="checkbox"/> c. post-award	3. Report Type: <input type="checkbox"/> a. initial filing <input type="checkbox"/> b. material change For Material Change Only: year _____ quarter _____ date of last report _____
4. Name and Address of Reporting Entity: <input type="checkbox"/> Prime <input type="checkbox"/> Subawardee Tier _____, if known: Congressional District, if known:	5. If Reporting Entity in No. 4 is a Subawardee, Enter Name and Address of Prime: Congressional District, if known:	
6. Federal Department/Agency:	7. Federal Program Name/Description: CFDA Number, if applicable: _____	
8. Federal Action Number, if known:	9. Award Amount, if known: \$ _____	
10. a. Name and Address of Lobbying Registrant <i>(if individual, last name, first name, MI):</i>	b. Individuals Performing Services <i>(including address if different from No. 10a)</i> <i>(last name, first name, MI):</i>	
11. Information requested through this form is authorized by title 31 U.S.C. section 1352. This disclosure of lobbying activities is a material representation of fact upon which reliance was placed by the tier above when this transaction was made or entered into. This disclosure is required pursuant to 31 U.S.C. 1352. This information will be available for public inspection. Any person who fails to file the required disclosure shall be subject to a civil penalty of not less than \$10,000 and not more than \$100,000 for each such failure.	Signature: _____ Print Name: _____ Title: _____ Telephone No.: _____ Date: _____	
Federal Use Only:		Authorized for Local Reproduction Standard Form LLL (Rev. 7-97)

INSTRUCTIONS FOR COMPLETION OF SF-LLL, DISCLOSURE OF LOBBYING ACTIVITIES

This disclosure form shall be completed by the reporting entity, whether subawardee or prime Federal recipient, at the initiation or receipt of a covered Federal action, or a material change to a previous filing, pursuant to title 31 U.S.C. section 1352. The filing of a form is required for each payment or agreement to make payment to any lobbying entity for influencing or attempting to influence an officer or employee of any agency, a Member of Congress, an officer or employee of Congress, or an employee of a Member of Congress in connection with a covered Federal action. Complete all items that apply for both the initial filing and material change report. Refer to the implementing guidance published by the Office of Management and Budget for additional information.

1. Identify the type of covered Federal action for which lobbying activity is and/or has been secured to influence the outcome of a covered Federal action.
2. Identify the status of the covered Federal action.
3. Identify the appropriate classification of this report. If this is a followup report caused by a material change to the information previously reported, enter the year and quarter in which the change occurred. Enter the date of the last previously submitted report by this reporting entity for this covered Federal action.
4. Enter the full name, address, city, State and zip code of the reporting entity. Include Congressional District, if known. Check the appropriate classification of the reporting entity that designates if it is, or expects to be, a prime or subaward recipient. Identify the tier of the subawardee, e.g., the first subawardee of the prime is the 1st tier. Subawards include but are not limited to subcontracts, subgrants and contract awards under grants.
5. If the organization filing the report in item 4 checks "Subawardee," then enter the full name, address, city, State and zip code of the prime Federal recipient. Include Congressional District, if known.
6. Enter the name of the Federal agency making the award or loan commitment. Include at least one organizational level below agency name, if known. For example, Department of Transportation, United States Coast Guard.
7. Enter the Federal program name or description for the covered Federal action (item 1). If known, enter the full Catalog of Federal Domestic Assistance (CFDA) number for grants, cooperative agreements, loans, and loan commitments.
8. Enter the most appropriate Federal identifying number available for the Federal action identified in item 1 (e.g., Request for Proposal (RFP) number; Invitation for Bid (IFB) number; grant announcement number; the contract, grant, or loan award number; the application/proposal control number assigned by the Federal agency). Include prefixes, e.g., "RFP-DE-90-001."
9. For a covered Federal action where there has been an award or loan commitment by the Federal agency, enter the Federal amount of the award/loan commitment for the prime entity identified in item 4 or 5.
10. (a) Enter the full name, address, city, State and zip code of the lobbying registrant under the Lobbying Disclosure Act of 1995 engaged by the reporting entity identified in item 4 to influence the covered Federal action.

(b) Enter the full names of the individual(s) performing services, and include full address if different from 10 (a). Enter Last Name, First Name, and Middle Initial (MI).
11. The certifying official shall sign and date the form, print his/her name, title, and telephone number.

According to the Paperwork Reduction Act, as amended, no persons are required to respond to a collection of information unless it displays a valid OMB Control Number. The valid OMB control number for this information collection is OMB No. 0348-0046. Public reporting burden for this collection of information is estimated to average 10 minutes per response, including time for reviewing instructions, searching existing data sources, gathering and maintaining the data needed, and completing and reviewing the collection of information. Send comments regarding the burden estimate or any other aspect of this collection of information, including suggestions for reducing this burden, to the Office of Management and Budget, Paperwork Reduction Project (0348-0046), Washington, DC 20503.

**Attachment B-2
HUD-50071
Certification of
Payments to
Influence Federal
Transactions**



Certification of Payments to Influence Federal Transactions

U.S. Department of Housing
and Urban Development
Office of Public and Indian Housing

Public reporting burden for this information collection is estimated to average 30 minutes. This includes the time for collecting, reviewing, and reporting data. The information requested is required to obtain a benefit. This form is used to ensure federal funds are not used to influence members of Congress. There are no assurances of confidentiality. HUD may not conduct or sponsor, and an applicant is not required to respond to a collection of information unless it displays a currently valid OMB control number.

Applicant Name

Program/Activity Receiving Federal Grant Funding

The undersigned certifies, to the best of his or her knowledge and belief, that:

(1) No Federal appropriated funds have been paid or will be paid, by or on behalf of the undersigned, to any person for influencing or attempting to influence an officer or employee of an agency, a Member of Congress, an officer or employee of Congress, or an employee of a Member of Congress in connection with the awarding of any Federal contract, the making of any Federal grant, the making of any Federal loan, the entering into of any cooperative agreement, and the extension, continuation, renewal, amendment, or modification of any Federal contract, grant, loan, or cooperative agreement.

(2) If any funds other than Federal appropriated funds have been paid or will be paid to any person for influencing or attempting to influence an officer or employee of an agency, a Member of Congress, an officer or employee of Congress, or an employee of a Member of Congress in connection with this Federal contract, grant, loan, or cooperative agreement, the undersigned shall complete and submit Standard Form-LLL, Disclosure Form to Report Lobbying, in accordance with its instructions.

(3) The undersigned shall require that the language of this certification be included in the award documents for all subawards at all tiers (including subcontracts, subgrants, and contracts under grants, loans, and cooperative agreements) and that all sub recipients shall certify and disclose accordingly.

This certification is a material representation of fact upon which reliance was placed when this transaction was made or entered into. Submission of this certification is a prerequisite for making or entering into this transaction imposed by Section 1352, Title 31, U.S. Code. Any person who fails to file the required certification shall be subject to a civil penalty of not less than \$10,000 and not more than \$100,000 for each such failure.

I hereby certify that all the information stated herein, as well as any information provided in the accompaniment herewith, is true and accurate.

Warning: HUD will prosecute false claims and statements. Conviction may result in criminal and/or civil penalties. (18 U.S.C. 1001, 1010, 1012; 31 U.S.C. 3729, 3802)

Name of Authorized Official

Title

Signature

Date (mm/dd/yyyy)

Attachment B-3
HUD-50070
Certification of a
Drug-Free Workplace



Certification for a Drug-Free Workplace

U.S. Department of Housing and Urban Development

Applicant Name

Program/Activity Receiving Federal Grant Funding

Acting on behalf of the above named Applicant as its Authorized Official, I make the following certifications and agreements to the Department of Housing and Urban Development (HUD) regarding the sites listed below:

I certify that the above named Applicant will or will continue to provide a drug-free workplace by:

a. Publishing a statement notifying employees that the unlawful manufacture, distribution, dispensing, possession, or use of a controlled substance is prohibited in the Applicant's workplace and specifying the actions that will be taken against employees for violation of such prohibition.

b. Establishing an on-going drug-free awareness program to inform employees ---

(1) The dangers of drug abuse in the workplace;

(2) The Applicant's policy of maintaining a drug-free workplace;

(3) Any available drug counseling, rehabilitation, and employee assistance programs; and

(4) The penalties that may be imposed upon employees for drug abuse violations occurring in the workplace.

c. Making it a requirement that each employee to be engaged in the performance of the grant be given a copy of the statement required by paragraph a.;

d. Notifying the employee in the statement required by paragraph a. that, as a condition of employment under the grant, the employee will ---

(1) Abide by the terms of the statement; and

(2) Notify the employer in writing of his or her conviction for a violation of a criminal drug statute occurring in the workplace no later than five calendar days after such conviction;

e. Notifying the agency in writing, within ten calendar days after receiving notice under subparagraph d.(2) from an employee or otherwise receiving actual notice of such conviction. Employers of convicted employees must provide notice, including position title, to every grant officer or other designee on whose grant activity the convicted employee was working, unless the Federalagency has designated a central point for the receipt of such notices. Notice shall include the identification number(s) of each affected grant;

f. Taking one of the following actions, within 30 calendar days of receiving notice under subparagraph d.(2), with respect to any employee who is so convicted ---

(1) Taking appropriate personnel action against such an employee, up to and including termination, consistent with the requirements of the Rehabilitation Act of 1973, as amended; or

(2) Requiring such employee to participate satisfactorily in a drug abuse assistance or rehabilitation program approved for such purposes by a Federal, State, or local health, law enforcement, or other appropriate agency;

g. Making a good faith effort to continue to maintain a drug-free workplace through implementation of paragraphs a. thru f.

2. Sites for Work Performance. The Applicant shall list (on separate pages) the site(s) for the performance of work done in connection with the HUD funding of the program/activity shown above: Place of Performance shall include the street address, city, county, State, and zip code. Identify each sheet with the Applicant name and address and the program/activity receiving grant funding.)

Check here if there are workplaces on file that are not identified on the attached sheets.

I hereby certify that all the information stated herein, as well as any information provided in the accompaniment herewith, is true and accurate.

Warning: HUD will prosecute false claims and statements. Conviction may result in criminal and/or civil penalties.

(18 U.S.C. 1001, 1010, 1012; 31 U.S.C. 3729, 3802)

Name of Authorized Official

Title

Signature

Date

X

Attachment C

Profile of Firm Form



INVITATION FOR BIDS (IFB) No. 23-912-28 Corrective Duct Work & Grille Replacement at Florida

PROFILE OF FIRM FORM
(Attachment C)

(This Form must be fully completed and included in the "hard copy" bid submittal.)

(1) Prime _____ Sub-contractor _____ (This form must be completed by and for each).

(2) Name of Firm: _____ Telephone: _____ Fax: _____

(3) Street Address, City, State, Zip: _____

(4) Please attach a brief biography/ resume of the company, including the following information:

(a) Year Firm Established; (b) Year Firm Established in [JURISDICTION]; (c) Former Name and Year Established (if applicable); (d) Name of Parent Company and Date Acquired (if applicable).

(5) Identify Principals/Partners in Firm (submit under Tab No. 5 a brief professional resume for each):

NAME	TITLE	% OF OWNERSHIP

(6) Identify the individual(s) that will act as project manager and any other supervisory personnel that will work on project; please submit under Tab No. 5 a brief resume for each. (Do not duplicate any resumes required above):

NAME	TITLE

(7) Bidder Diversity Statement: You must circle all of the following that apply to the ownership of this firm and enter where provided the correct percentage (%) of ownership of each:

Caucasian American (Male) _____%
 Public-Held Corporation _____%
 Government Agency _____%
 Non-Profit Organization _____%

Resident- (RBE), Minority- (MBE), or Woman-Owned (WBE) Business Enterprise (Qualifies by virtue of 51% or more ownership and active management by one or more of the following:

Resident-Owned* _____%
 African American _____%
 **Native American _____%
 Hispanic American _____%
 Asian/Pacific American _____%
 Hasidic Jew _____%
 Asian/Indian American _____%

Woman-Owned (MBE) _____%
 Woman-Owned (Caucasian) _____%
 Disabled Veteran _____%
 Other (Specify): _____%

WMBE Certification Number (if known): _____

Certified by (Agency): _____

Signature _____ Date _____ Printed Name _____ Company _____

PROFILE OF FIRM FORM
(Attachment C)

(This Form must be fully completed and placed under Tab No. 3 of the "hard copy" tabbed bid submittal.)

- (8) Federal Tax ID No.: _____
- (9) [APPROPRIATE JURISDICTION] Business License No.: _____
- (10) State of _____ License Type and No.: _____
- (11) Worker's Compensation Insurance Carrier: _____
Policy No.: _____ Expiration Date: _____
- (12) General Liability Insurance Carrier: _____
Policy No. _____ Expiration Date: _____
- (13) Professional Liability Insurance Carrier: _____
Policy No. _____ Expiration Date: _____
- (14) Debarred Statement: Has this firm, or any principal(s) ever been debarred from providing any services by the Federal Government, any state government, the State of _____, or any local government agency within or without the State of _____? Yes No
If "Yes," please attach a full detailed explanation, including dates, circumstances and current status.
- (15) Disclosure Statement: Does this firm or any principals thereof have any current, past personal or professional relationship with any Commissioner or Officer of the HA? Yes No
If "Yes," please attach a full detailed explanation, including dates, circumstances and current status.
- (16) Non-Collusive Affidavit: The undersigned party submitting this bid hereby certifies that such bid is genuine and not collusive and that said bidder entity has not colluded, conspired, connived or agreed, directly or indirectly, with any bidder or person, to put in a sham bid or to refrain from proposing, and has not in any manner, directly or indirectly sought by agreement or collusion, or communication or conference, with any person, to fix the bid price of affiant or of any other bidder, to fix overhead, profit or cost element of said bid price, or that of any other bidder or to secure any advantage against the HA or any person interested in the proposed contract; and that all statements in said bid are true.
- (17) Verification Statement: The undersigned bidder hereby states that by completing and submitting this form he/she is verifying that all information provided herein is, to the best of his/her knowledge, true and accurate, and agrees that if the HA discovers that any information entered herein is false, that shall entitle the HA to not consider nor make award or to cancel any award with the undersigned party.

Signature Date Printed Name Company

Attachment D

Section 3

Submittal Form



Section 3 Business Preference Submittal Form

(Attachment D)

- 10 **Introduction:** This form must be fully completed, accompanied by all required attachments, for any bidder/bidder claiming a Section 3 Business Preference (hereinafter, "Preference").
- 11 This fully completed form and any attachments thereto, will become a part of any ensuing contract.
- 12 Each bidder/bidder shall mark an "X" where provided following for all that apply to his/her claim of a Preference.
- 13 The bidder/bidder shall provide as an attachment to this completed form a detailed work plan clearly explaining how each following "denoted effort" or "claim" will be accomplished). Failure on the part of the bidder/bidder to include any such required attachment fully explaining the claim of the bidder/bidder shall result in the HA not considering the claim for a Preference (though the HA will, if awarded, later require the bidder/bidder to submit the information to satisfy the Section 3 requirements of the ensuing contract).
- 14 Please note that, even if a bidder/bidder does not complete and submit this form claiming a Preference, the HA may require this form to be completed by the successful bidder/bidder as an attachment to the ensuing contract to document the Section 3 Plan required for the ensuing contract.
- 20 **Current Section 3 Status:** The undersigned bidder/bidder hereby claims that it is a Section 3 business concern and claims such preference in that he/she can provide evidence that (the bidder/bidder has attached justifying documentation for each item following marked with an "X"):
- 21 ___ It is 51% or more owned by a Section 3 resident:
- 2.1.1 ___ HA resident lease;
- 2.1.2 ___ Evidence of participation in a public assistance program;
- 2.1.3 ___ Articles of Incorporation;
- 2.1.4 ___ Fictitious or Assumed Business Name Certificate;
- 2.1.5 ___ List of owners/stockholders and % of each;
- 2.1.6 ___ Latest Board minutes appointing officers;
- 2.1.7 ___ Organization chart with names and titles and brief functional statement;
- 2.1.8 ___ Partnership Agreement;
- 2.1.9 ___ Corporation Annual Report.
- 22 ___ At least 30% of its full time employees include persons that are currently Section 3 residents, or within 3 years of the date of first employment with the business concern were Section 3 residents:

2.2.1 To justify this claim, please see the immediate following:

(1) Classification	(2) Total Number of Current Permanent Employees	(3) Total Number of Section 3 Resident Employees
Trainees		
Apprentices		
Journeypersons		
Laborers		
Supervisory		
Superintendent		
Professional		
Clerical		
Other:		

2.2.2 Attach a listing of all employees listed within column (3) above, including name and total annual income.

23 He/she has a commitment to subcontract in excess of 25% of the dollar award of all subcontracts to be awarded to a Section 3 business concern.

2.3.1 To justify this claim, please see the immediate following:

(1) Name of Section 3 Firm Receiving the Subcontract	(2) Total Amount of Subcontract(s)	(3) Percentage the Subcontract(s) is/are of the Total Proposed Contract Amount
	\$	%
	\$	%
	\$	%

2.3.2 Attach for each firm listed immediately above:

2.3.2.1 A detailed description of the subcontracted activity; and

2.3.2.2 A fully completed Profile of Firm form.

30 **Section 3 Preference Claim, Training and Employment Opportunities:** The undersigned bidder/bidder hereby claims that it will, as detailed within 24 CFR §135.34, provide such "opportunities" as denoted following; to:

INVITATION FOR BIDS (IFB) No. 23-912-28 Corrective Duct Work & Grille Replacement at Florida

- 31 Residents of the housing development or developments for which the section 3 covered assistance is expended (category 1 residents);
- 32 Residents of other housing developments managed by the HA that is expending the section 3 covered housing assistance (category 2 residents);
- 33 Participants in HUD Youthbuild programs being carried out in the metropolitan area (or nonmetropolitan county) in which the section 3 covered assistance is expended (category 3 residents);
- 34 Other section 3 residents.

3.8 Section 3 Preference Claim, Section 3 Business Concerns: The undersigned bidder/bidder hereby claims that it will, as a result of the contract award, and as detailed within 24 CFR §135.36, provide such "opportunities" as denoted following; to:

- 41 Business concerns that are 51 percent or more owned by residents of the housing development or developments for which the section 3 covered assistance is expended, or whose full-time, permanent workforce includes 30 percent of these persons as employees (category 1 businesses);
- 42 Business concerns that are 51 percent or more owned by residents of other housing developments or developments managed by the HA that is expending the section 3 covered assistance, or whose full-time, permanent workforce includes 30 percent of these persons as employees (category 2 businesses); or
- 43 HUD Youthbuild programs being carried out in the metropolitan area (or nonmetropolitan county/parish) in which the section 3 covered assistance is expended (category 3 businesses).
- 44 Business concerns that are 51 percent or more owned by section 3 residents, or whose permanent, full-time workforce includes no less than 30 percent section 3 residents (category 4 businesses), or that subcontract in excess of 25 percent of the total amount of subcontracts to business concerns identified in paragraphs (a)(1)(i) and (a)(1)(ii) of this section.

5.0 As further detailed herein, which of the following priority are you claiming? (NOTE: Mark with an "X" the highest claimed Priority only.)

PRIORITY CLAIMED (Mark "X")	FACTOR DESCRIPTION
	SECTION 3 BUSINESS PREFERENCE PARTICIPATION:
	Priority I, Category 1a: Business concerns that are 51 percent or more owned by residents of the housing development or developments for which the Section 3-covered assistance is expended.
	Priority II, Category 1b: Business concerns whose workforce includes 30 percent of residents of the

INVITATION FOR BIDS (IFB) No. 23-912-28 Corrective Duct Work & Grille Replacement at Florida

	housing development for which the Section 3-covered assistance is expended, or within three (3) years of the date of first employment with the business concern, were residents of the Section 3-covered housing development.
	Priority III, Category 2a: Business concerns that are 51 percent or more owned by residents of any other housing development or developments.
	Priority IV, Category 2b: Business concerns whose workforce includes 30 percent of residents of any other public housing development or developments, or within three (3) years of the date of first employment with the business concern, were "Section 3" residents of any other public housing development.
	Priority V, Category 3: Business concerns participating in HUD Youth-build programs being carried out in the metropolitan area in which the Section 3-covered assistance is expended.
	Priority VI, Category 4a: Business concerns that are 51 percent or more owned by Section 3 residents in the metropolitan area, or whose permanent, full-time workforce includes no less than 30 percent of Section 3 residents in the metropolitan area, or within three (3) years of the date of employment with the business concern, were Section 3 residents in the metropolitan area.
	Priority VII, Category 4b: Business concerns that subcontract in excess of 25 percent of the total amount of subcontracts to Section 3 business concerns.

- 60 As detailed within 24 CFR §135, Appendix I, *Examples of Efforts To Offer Training and Employment Opportunities to Section 3 Residents*, denote the "efforts" your firm hereby formally commits to implement if you are awarded a contract:
- 61 ___ Entering into "first source" hiring agreements with organizations representing Section 3 residents.
 - 62 ___ Sponsoring a HUD-certified "Step-Up" employment and training program for section 3 residents.
 - 63 ___ Establishing training programs, which are consistent with the requirements of the Department of Labor, for public and Indian housing residents and other section 3 residents in the building trades.
 - 64 ___ Advertising the training and employment positions by distributing flyers (which identify the positions to be filled, the qualifications required, and where to obtain additional information about the application process) to every occupied dwelling unit in the housing

development or developments where category 1 or category 2 persons (as these terms are defined in §135.34) reside.

- 6.5 ___ Advertising the training and employment positions by posting flyers (which identify the positions to be filled, the qualifications required, and where to obtain additional information about the application process) in the common areas or other prominent areas of the housing development or developments. For HAs, post such advertising in the housing development or developments where category 1 or category 2 persons reside; for all other recipients, post such advertising in the housing development or developments and transitional housing in the neighborhood or service area of the section 3 covered project.
- 6.6 ___ Contacting resident councils, resident management corporations, or other resident organizations, where they exist, in the housing development or developments where category 1 or category 2 persons reside, and community organizations in HUD-assisted neighborhoods, to request the assistance of these organizations in notifying residents of the training and employment positions to be filled.
- 6.7 ___ Sponsoring (scheduling, advertising, financing or providing in-kind services) a job informational meeting to be conducted by an HA or contractor representative or representatives at a location in the housing development or developments where category 1 or category 2 persons reside or in the neighborhood or service area of the section 3 covered project.
- 6.8 ___ Arranging assistance in conducting job interviews and completing job applications for residents of the housing development or developments where category 1 or category 2 persons reside and in the neighborhood or service area in which a section 3 project is located.
- 6.9 ___ Arranging for a location in the housing development or developments where category 1 persons reside, or the neighborhood or service area of the project, where job applications may be delivered to and collected by a recipient or contractor representative or representatives.
- 6.10 ___ Conducting job interviews at the housing development or developments where category 1 or category 2 persons reside, or at a location within the neighborhood or service area of the section 3 covered project.
- 6.11 ___ Contacting agencies administering HUD Youthbuild programs, and requesting their assistance in recruiting HUD Youthbuild program participants for the HA's or contractor's training and employment positions.
- 6.12 ___ Consulting with State and local agencies administering training programs funded through JTPA or JOBS, probation and parole agencies, unemployment compensation programs, community organizations and other officials or organizations to assist with recruiting Section 3 residents for the HA's or contractor's training and employment positions.
- 6.13 ___ Advertising the jobs to be filled through the local media, such as community television networks, newspapers of general circulation, and radio advertising.
- 6.14 ___ Employing a job coordinator, or contracting with a business concern that is licensed in the field of job placement (preferably one of the section 3 business concerns identified in part 135), that will undertake, on behalf of the HA, other recipient or contractor, the efforts to match

eligible and qualified section 3 residents with the training and employment positions that the HA or contractor intends to fill.

- 6.15 ___ For an HA, employing section 3 residents directly on either a permanent or a temporary basis to perform work generated by section 3 assistance. (This type of employment is referred to as "force account labor" in HUD's Indian housing regulations. See 24 CFR §905.102, and §905.201(a)(6).)
- 6.16 ___ Where there are more qualified section 3 residents than there are positions to be filled, maintaining a file of eligible qualified section 3 residents for future employment positions.
- 6.17 ___ Undertaking job counseling, education and related programs in association with local educational institutions.
- 6.18 ___ Undertaking such continued job training efforts as may be necessary to ensure the continued employment of section 3 residents previously hired for employment opportunities.
- 6.19 ___ After selection of bidders but prior to execution of contracts, incorporating into the contract a negotiated provision for a specific number of public housing or other section 3 residents to be trained or employed on the section 3 covered assistance.
- 6.20 ___ Coordinating plans and implementation of economic development (e.g., job training and preparation, business development assistance for residents) with the planning for housing and community development.

7.0 As detailed within 24 CFR §135, Appendix II, *Examples of Efforts To Award Contracts to Section 3 Business Concerns*, denote following the "efforts" your firm hereby formally commits to implement if you are awarded a contract:

- 7.1 ___ Utilizing procurement procedures for section 3 business concerns similar to those provided in 24 CFR part 905 for business concerns owned by Native Americans (see section III of this Appendix).
- 7.2 ___ In determining the responsibility of potential contractors, consider their record of section 3 compliance as evidenced by past actions and their current plans for the pending contract.
- 7.3 ___ Contacting business assistance agencies, minority contractors associations and community organizations to inform them of contracting opportunities and requesting their assistance in identifying section 3 businesses which may solicit bids or bids for contracts for work in connection with section 3 covered assistance.
- 7.4 ___ Advertising contracting opportunities by posting notices, which provide general information about the work to be contracted and where to obtain additional information, in the common areas or other prominent areas of the housing development or developments owned and managed by the HA.
- 7.5 ___ For HAs, contacting resident councils, resident management corporations, or other resident organizations, where they exist, and requesting their assistance in identifying category 1 and category 2 business concerns.

- 7.6 ___ Providing written notice to all known section 3 business concerns of the contracting opportunities. This notice should be in sufficient time to allow the section 3 business concerns to respond to the bid invitations or Invitation for Bids.
- 7.7 ___ Following up with section 3 business concerns that have expressed interest in the contracting opportunities by contacting them to provide additional information on the contracting opportunities.
- 7.8 ___ Coordinating pre-bid meetings at which section 3 business concerns could be informed of upcoming contracting and subcontracting opportunities.
- 7.9 ___ Carrying out workshops on contracting procedures and specific contract opportunities in a timely manner so that section 3 business concerns can take advantage of upcoming contracting opportunities, with such information being made available in languages other than English where appropriate.
- 7.10 ___ Advising section 3 business concerns as to where they may seek assistance to overcome limitations such as inability to obtain bonding, lines of credit, financing, or insurance.
- 7.11 ___ Arranging solicitations, times for the presentation of bids, quantities, specifications, and delivery schedules in ways to facilitate the participation of section 3 business concerns.
- 7.12 ___ Where appropriate, breaking out contract work items into economically feasible units to facilitate participation by section 3 business concerns.
- 7.13 ___ Contacting agencies administering HUD Youthbuild programs, and notifying these agencies of the contracting opportunities.
- 7.14 ___ Advertising the contracting opportunities through trade association papers and newsletters, and through the local media, such as community television networks, newspapers of general circulation, and radio advertising.
- 7.15 ___ Developing a list of eligible section 3 business concerns.
- 7.16 ___ For HAs, participating in the "Contracting with Resident-Owned Businesses" program provided under 24 CFR part 963.
- 7.17 ___ Establishing or sponsoring programs designed to assist residents of public or Indian housing in the creation and development of resident-owned businesses.
- 7.18 ___ Establishing numerical goals (number of awards and dollar amount of contracts) for award of contracts to section 3 business concerns.
- 7.19 ___ Supporting businesses which provide economic opportunities to low income persons by linking them to the support services available through the Small Business Administration (SBA), the Department of Commerce and comparable agencies at the State and local levels.
- 7.20 ___ Encouraging financial institutions, in carrying out their responsibilities under the Community Reinvestment Act, to provide no or low interest loans for providing working capital and other financial business needs.
- 7.21 ___ Actively supporting joint ventures with section 3 business concerns.

INVITATION FOR BIDS (IFB) No. 23-912-28 Corrective Duct Work & Grille Replacement at Florida

7.22 ___ Actively supporting the development or maintenance of business incubators which assist Section 3 business concerns.

8.0 The undersigned bidder/bidder hereby declares:

8.1 The information within this completed form (and any attachments) is, to the best of his/her knowledge, true and accurate.

8.2 He/she is aware that if the HA discovers that any such information is not true and accurate, such shall allow the HA to:

8.2.1 NOT award the bidder/bidder a Preference; and

8.2.2 If the HA deems such is warranted (e.g. in the case of submitting information the bidder/bidder knows to be untrue), declare such bidder/bidder to be nonresponsive and not allow the bidder/bidder to receive an award.

8.3 He/she is aware that if he/she receives an award as the result of this competitive solicitation, even though he/she may not receive a Preference from the HA as a result of this submittal, he/she will still be required to, to the greatest extent feasible, implement a Section 3 Plan, including a commitment to interview and consider hiring Section 3 persons (most specifically, residents of the HA) whenever the successful bidder/bidder has need to hire additional employees during the term of the ensuing contract.

Signature

Date

Printed Name

Company

Attachment E

HUD- 5369-A



**U.S. Department of Housing
and Urban Development**
Office of Public and Indian Housing

**Representations, Certifications,
and Other Statements of Bidders**
Public and Indian Housing Programs

Representations, Certifications, and Other Statements of Bidders

Public and Indian Housing Programs

Table of Contents

Clause	Page
1. Certificate of Independent Price Determination	1
2. Contingent Fee Representation and Agreement	1
3. Certification and Disclosure Regarding Payments to Influence Certain Federal Transactions	1
4. Organizational Conflicts of Interest Certification	2
5. Bidder's Certification of Eligibility	2
6. Minimum Bid Acceptance Period	2
7. Small, Minority, Women-Owned Business Concern Representation	2
8. Indian-Owned Economic Enterprise and Indian Organization Representation	2
9. Certification of Eligibility Under the Davis-Bacon Act	3
10. Certification of Nonsegregated Facilities	3
11. Clean Air and Water Certification	3
12. Previous Participation Certificate	3
13. Bidder's Signature	3

1. Certificate of Independent Price Determination

(a) The bidder certifies that--

(1) The prices in this bid have been arrived at independently, without, for the purpose of restricting competition, any consultation, communication, or agreement with any other bidder or competitor relating to (i) those prices, (ii) the intention to submit a bid, or (iii) the methods or factors used to calculate the prices offered;

(2) The prices in this bid have not been and will not be knowingly disclosed by the bidder, directly or indirectly, to any other bidder or competitor before bid opening (in the case of a sealed bid solicitation) or contract award (in the case of a competitive proposal solicitation) unless otherwise required by law; and

(3) No attempt has been made or will be made by the bidder to induce any other concern to submit or not to submit a bid for the purpose of restricting competition.

(b) Each signature on the bid is considered to be a certification by the signatory that the signatory--

(1) Is the person in the bidder's organization responsible for determining the prices being offered in this bid or proposal, and that the signatory has not participated and will not participate in any action contrary to subparagraphs (a)(1) through (a)(3) above; or

(2) (i) Has been authorized, in writing, to act as agent for the following principals in certifying that those principals have not participated, and will not participate in any action contrary to subparagraphs (a)(1) through (a)(3) above.

_____ [insert full name of person(s) in the bidder's organization responsible for determining the prices offered in this bid or proposal, and the title of his or her position in the bidder's organization];

(ii) As an authorized agent, does certify that the principals named in subdivision (b)(2)(i) above have not participated, and will not participate, in any action contrary to subparagraphs (a)(1) through (a)(3) above; and

(iii) As an agent, has not personally participated, and will not participate in any action contrary to subparagraphs (a)(1) through (a)(3) above.

(c) If the bidder deletes or modifies subparagraph (a)2 above, the bidder must furnish with its bid a signed statement setting forth in detail the circumstances of the disclosure.

[] [Contracting Officer check if following paragraph is applicable]

(d) Non-collusive affidavit. (applicable to contracts for construction and equipment exceeding \$50,000)

(1) Each bidder shall execute, in the form provided by the PHA/IHA, an affidavit to the effect that he/she has not colluded with any other person, firm or corporation in regard to any bid submitted in response to this solicitation. If the successful bidder did not submit the affidavit with his/her bid, he/she must submit it within three (3) working days of bid opening. Failure to submit the affidavit by that date may render the bid nonresponsive. No contract award will be made without a properly executed affidavit.

(2) A fully executed "Non-collusive Affidavit" [] is, [] is not included with the bid.

2. Contingent Fee Representation and Agreement

(a) Definitions. As used in this provision:

"Bona fide employee" means a person, employed by a bidder and subject to the bidder's supervision and control as to time, place, and manner of performance, who neither exerts, nor proposes to exert improper influence to solicit or obtain contracts nor holds out as being able to obtain any contract(s) through improper influence.

"Improper influence" means any influence that induces or tends to induce a PHA/IHA employee or officer to give consideration or to act regarding a PHA/IHA contract on any basis other than the merits of the matter.

(b) The bidder represents and certifies as part of its bid that, except for full-time bona fide employees working solely for the bidder, the bidder:

(1) [] has, [] has not employed or retained any person or company to solicit or obtain this contract; and

(2) [] has, [] has not paid or agreed to pay to any person or company employed or retained to solicit or obtain this contract any commission, percentage, brokerage, or other fee contingent upon or resulting from the award of this contract.

(c) If the answer to either (a)(1) or (a)(2) above is affirmative, the bidder shall make an immediate and full written disclosure to the PHA/IHA Contracting Officer.

(d) Any misrepresentation by the bidder shall give the PHA/IHA the right to (1) terminate the contract; (2) at its discretion, deduct from contract payments the amount of any commission, percentage, brokerage, or other contingent fee; or (3) take other remedy pursuant to the contract.

3. Certification and Disclosure Regarding Payments to Influence Certain Federal Transactions (applicable to contracts exceeding \$100,000)

(a) The definitions and prohibitions contained in Section 1352 of title 31, United States Code, are hereby incorporated by reference in paragraph (b) of this certification.

(b) The bidder, by signing its bid, hereby certifies to the best of his or her knowledge and belief as of December 23, 1989 that:

(1) No Federal appropriated funds have been paid or will be paid to any person for influencing or attempting to influence an officer or employee of any agency, a Member of Congress, an officer or employee of Congress, or an employee of a Member of Congress on his or her behalf in connection with the awarding of a contract resulting from this solicitation;

(2) If any funds other than Federal appropriated funds (including profit or fee received under a covered Federal transaction) have been paid, or will be paid, to any person for influencing or attempting to influence an officer or employee of any agency, a Member of Congress, an officer or employee of Congress, or an employee of a Member of Congress on his or her behalf in connection with this solicitation, the bidder shall complete and submit, with its bid, OMB standard form LLL, "Disclosure of Lobbying Activities;" and

(3) He or she will include the language of this certification in all subcontracts at any tier and require that all recipients of subcontract awards in excess of \$100,000 shall certify and disclose accordingly.

(c) Submission of this certification and disclosure is a prerequisite for making or entering into this contract imposed by section 1352, title 31, United States Code. Any person who makes an expenditure prohibited under this provision or who fails to file or amend the disclosure form to be filed or amended by this provision, shall be subject to a civil penalty of not less than \$10,000, and not more than \$100,000, for each such failure.

(d) Indian tribes (except those chartered by States) and Indian organizations as defined in section 4 of the Indian Self-Determination and Education Assistance Act (25 U.S.C. 450B) are exempt from the requirements of this provision.

4. Organizational Conflicts of Interest Certification

The bidder certifies that to the best of its knowledge and belief and except as otherwise disclosed, he or she does not have any organizational conflict of interest which is defined as a situation in which the nature of work to be performed under this proposed contract and the bidder's organizational, financial, contractual, or other interests may, without some restriction on future activities:

- (a) Result in an unfair competitive advantage to the bidder; or,
- (b) Impair the bidder's objectivity in performing the contract work.

[] In the absence of any actual or apparent conflict, I hereby certify that to the best of my knowledge and belief, no actual or apparent conflict of interest exists with regard to my possible performance of this procurement.

5. Bidder's Certification of Eligibility

(a) By the submission of this bid, the bidder certifies that to the best of its knowledge and belief, neither it, nor any person or firm which has an interest in the bidder's firm, nor any of the bidder's subcontractors, is ineligible to:

(1) Be awarded contracts by any agency of the United States Government, HUD, or the State in which this contract is to be performed; or,

(2) Participate in HUD programs pursuant to 24 CFR Part 24.

(b) The certification in paragraph (a) above is a material representation of fact upon which reliance was placed when making award. If it is later determined that the bidder knowingly rendered an erroneous certification, the contract may be terminated for default, and the bidder may be debarred or suspended from participation in HUD programs and other Federal contract programs.

6. Minimum Bid Acceptance Period

(a) "Acceptance period," as used in this provision, means the number of calendar days available to the PHA/IHA for awarding a contract from the date specified in this solicitation for receipt of bids.

(b) This provision supersedes any language pertaining to the acceptance period that may appear elsewhere in this solicitation.

(c) The PHA/IHA requires a minimum acceptance period of [Contracting Officer insert time period] calendar days.

(d) In the space provided immediately below, bidders may specify a longer acceptance period than the PHA's/IHA's minimum requirement. The bidder allows the following acceptance period: calendar days.

(e) A bid allowing less than the PHA's/IHA's minimum acceptance period will be rejected.

(f) The bidder agrees to execute all that it has undertaken to do, in compliance with its bid, if that bid is accepted in writing within (1) the acceptance period stated in paragraph (c) above or (2) any longer acceptance period stated in paragraph (d) above.

7. Small, Minority, Women-Owned Business Concern Representation

The bidder represents and certifies as part of its bid/ offer that it --

(a) [] is, [] is not a small business concern. "Small business concern," as used in this provision, means a concern, including its affiliates, that is independently owned and operated, not dominant in the field of operation in which it is bidding, and qualified as a small business under the criteria and size standards in 13 CFR 121.

(b) [] is, [] is not a women-owned business enterprise. "Women-owned business enterprise," as used in this provision, means a business that is at least 51 percent owned by a woman or women who are U.S. citizens and who also control and operate the business.

(c) [] is, [] is not a minority business enterprise. "Minority business enterprise," as used in this provision, means a business which is at least 51 percent owned or controlled by one or more minority group members or, in the case of a publicly owned business, at least 51 percent of its voting stock is owned by one or more minority group members, and whose management and daily operations are controlled by one or more such individuals. For the purpose of this definition, minority group members are:

(Check the block applicable to you)

- | | |
|------------------------|------------------------------|
| [] Black Americans | [] Asian Pacific Americans |
| [] Hispanic Americans | [] Asian Indian Americans |
| [] Native Americans | [] Hasidic Jewish Americans |

8. Indian-Owned Economic Enterprise and Indian Organization Representation (applicable only if this solicitation is for a contract to be performed on a project for an Indian Housing Authority)

The bidder represents and certifies that it:

(a) [] is, [] is not an Indian-owned economic enterprise. "Economic enterprise," as used in this provision, means any commercial, industrial, or business activity established or organized for the purpose of profit, which is at least 51 percent Indian owned. "Indian," as used in this provision, means any person who is a member of any tribe, band, group, pueblo, or community which is recognized by the Federal Government as eligible for services from the Bureau of Indian Affairs and any "Native" as defined in the Alaska Native Claims Settlement Act.

(b) [] is, [] is not an Indian organization. "Indian organization," as used in this provision, means the governing body of any Indian tribe or entity established or recognized by such governing body. Indian "tribe" means any Indian tribe, band, group, pueblo, or

community including Native villages and Native groups (including corporations organized by Kenai, Juneau, Sitka, and Kodiak) as defined in the Alaska Native Claims Settlement Act, which is recognized by the Federal Government as eligible for services from the Bureau of Indian Affairs.

9. Certification of Eligibility Under the Davis-Bacon Act (applicable to construction contracts exceeding \$2,000)

(a) By the submission of this bid, the bidder certifies that neither it nor any person or firm who has an interest in the bidder's firm is a person or firm ineligible to be awarded contracts by the United States Government by virtue of section 3(a) of the Davis-Bacon Act or 29 CFR 5.12(a)(1).

(b) No part of the contract resulting from this solicitation shall be subcontracted to any person or firm ineligible to be awarded contracts by the United States Government by virtue of section 3(a) of the Davis-Bacon Act or 29 CFR 5.12(a)(1).

(c) The penalty for making false statements is prescribed in the U. S. Criminal Code, 18 U.S.C. 1001.

10. Certification of Nonsegregated Facilities (applicable to contracts exceeding \$10,000)

(a) The bidder's attention is called to the clause entitled **Equal Employment Opportunity** of the General Conditions of the Contract for Construction.

(b) "Segregated facilities," as used in this provision, means any waiting rooms, work areas, rest rooms and wash rooms, restaurants and other eating areas, time clocks, locker rooms and other storage or dressing areas, parking lots, drinking fountains, recreation or entertainment areas, transportation, and housing facilities provided for employees, that are segregated by explicit directive or are in fact segregated on the basis of race, color, religion, or national origin because of habit, local custom, or otherwise.

(c) By the submission of this bid, the bidder certifies that it does not and will not maintain or provide for its employees any segregated facilities at any of its establishments, and that it does not and will not permit its employees to perform their services at any location under its control where segregated facilities are maintained. The bidder agrees that a breach of this certification is a violation of the Equal Employment Opportunity clause in the contract.

(d) The bidder further agrees that (except where it has obtained identical certifications from proposed subcontractors for specific time periods) prior to entering into subcontracts which exceed \$10,000 and are not exempt from the requirements of the Equal Employment Opportunity clause, it will:

- (1) Obtain identical certifications from the proposed subcontractors;
- (2) Retain the certifications in its files; and
- (3) Forward the following notice to the proposed subcontractors (except if the proposed subcontractors have submitted identical certifications for specific time periods):

Notice to Prospective Subcontractors of Requirement for Certifications of Nonsegregated Facilities

A Certification of Nonsegregated Facilities must be submitted before the award of a subcontract exceeding \$10,000 which is not exempt from the provisions of the Equal Employment Opportunity clause of the prime contract. The certification may be submitted either for each subcontract or for all subcontracts during a period (i.e., quarterly, semiannually, or annually).

Note: The penalty for making false statements in bids is prescribed in 18 U.S.C. 1001.

11. Clean Air and Water Certification (applicable to contracts exceeding \$100,000)

The bidder certifies that:

(a) Any facility to be used in the performance of this contract [] is, [] is not listed on the Environmental Protection Agency List of Violating Facilities:

(b) The bidder will immediately notify the PHA/IHA Contracting Officer, before award, of the receipt of any communication from the Administrator, or a designee, of the Environmental Protection Agency, indicating that any facility that the bidder proposes to use for the performance of the contract is under consideration to be listed on the EPA List of Violating Facilities; and,

(c) The bidder will include a certification substantially the same as this certification, including this paragraph (c), in every nonexempt subcontract.

12. Previous Participation Certificate (applicable to construction and equipment contracts exceeding \$50,000)

(a) The bidder shall complete and submit with his/her bid the Form HUD-2530, "Previous Participation Certificate." If the successful bidder does not submit the certificate with his/her bid, he/she must submit it within three (3) working days of bid opening. Failure to submit the certificate by that date may render the bid nonresponsive. No contract award will be made without a properly executed certificate.

(b) A fully executed "Previous Participation Certificate" [] is, [] is not included with the bid.

13. Bidder's Signature

The bidder hereby certifies that the information contained in these certifications and representations is accurate, complete, and current.

(Signature and Date)

(Typed or Printed Name)

(Title)

(Company Name)

(Company Address)

Attachment F Supplemental Conditions



SUPPLEMENTAL CONDITIONS

The Contractor shall possess a major classification in Mechanical Construction

The following supplements and/or modifies the "General Conditions for Construction Contracts," form HUD-5370:

Time of Completion. The Contractor shall commence work under this contract at the time stipulated in the written "Notice to Proceed" (NTP) issued by the local authority. The Contractor shall complete the work in 90 calendar days. The work shall be considered complete only when the Local Authority has issued its formal "Certificate of Acceptance".

Liquidated Damages

The cost per day in Liquidated Damages for delay on completion of this project is \$353.00.

Contract Type

The contract resulting from this IFB shall be a lump sum fixed price contract. Construction services shall be paid at fixed rates, in accordance with the contractor's Base Bid, pending HUD Funding.

Davis Bacon

Davis Wage Rates are in effect for this project.

Bonding

All bids must be accompanied by a bid bond/guarantee, which shall be in the form of a certified check, cashier's check, or bid bond for not less than five percent of the contract price of work to be done, as evidence of good faith of the bidder.

The awarded bidder will be required to provide a performance bond in an amount not less than one-half of the amount of the contract, for faithful performance of their duties.

Employment, Training and Contracting Policy

PART I- POLICY, PURPOSE, REQUIREMENTS, DEFINITIONS

- A. INTRODUCTION AND SUMMARY
- B. DEFINITIONS
- C. HANO SECTION 3 & DBE/WBE POLICY STATEMENTS
- D. SECTION 3 NEW HIRE AND CONTRACTING REQUIREMENTS
- E. DBE/WBE CONTRACT REQUIREMENTS

PART II- PROCUREMENT & CONTRACTOR REQUIREMENTS AND PROCEDURES

- A. SECTION 3 CONTRACTING PROCEDURES.
- B. DBE/WBE CONTRACTING PROCEDURES
- C. REPORTING OPEN POSITIONS

PART III - COMPLIANCE REQUIREMENTS

- A. COMPLIANCE REQUIREMENTS FOR HIRING & CONTRACTING
- B. PROJECT LABOR AGREEMENTS OR COMMUNITY WORKFORCE AGREEMENTS

PART IV - TRAINING REQUIREMENTS

- A. TRAINING AND INTERNSHIP REQUIREMENTS

PART V - CONTRACTING AND COMPLIANCE FORMS

- A. SECTION -3 INDIVIDUAL VERIFICATION FORM
- B. SECTION -3 EMPLOYMENT ACTION PLAN
- C. SECTION -3 TRAINING ACTION PLAN
- D. CONTRACTING ACTION PLAN FOR SECTION 3/DBE/WBE
- E. LIST OF CORE EMPLOYEES
- F. CONTRACTING SCHEDULE
- G. SECTION -3 EMPLOYMENT AND TRAINING SCHEDULE
- H. LETTER OF INTENT
- I. STATEMENT OF UNDERSTANDING
- J. CONTRACTORS SECTION -3 EMPLOYMENT AND TRAINING COMPLIANCE REPORT
- K. EMPLOYER PAID TRAINING REPORT
- L. SECTION -3 MANHOURLY REPORT
- M. CONTRACTING COMPLIANCE REPORT
- N. EMPLOYMENT ASSESSMENT

Invoicing

Invoices shall be submitted monthly to the Department of Finance with a copy to the Modernization and Development Department. The invoice shall provide an invoice number, service dates, purchase order number, Task Order number, and a description of services provided and the name/title of employee who rendered the services. Invoices shall be submitted on the contractor's own invoice form.

Payments

All vendors should submit invoices to the Finance Department on or before the days listed below. All vendor invoices are due on the 1st or 15th of the month. Invoice payments are as follows:

- *Invoices received on the 16th of the current month thru the 1st day of the next month will be paid on the 1st of the following month.*
- **Example: An invoice received on August 27th will be processed commencing September 1st and paid on October 1st.**
- *Invoices received on the 2nd of the current month thru the 15th of the current month will be paid on the 15th of the following month.*
- **Example: An invoice received on August 4th will be processed commencing August 15th and paid on September 15th.**

Request for Taxpayer Number and Certification (W-9)

The respondent(s) shall provide a copy of its Request for Taxpayer Number and Certification (W-9) at the time and date specified by the Authority.

Public Access to Procurement Information/Confidentiality

All information submitted in response to a solicitation issued by the Housing Authority of New Orleans (HANO) shall remain confidential until after final approval by HANO's Board of Commissioners and/or the United States Department of Housing and Urban Development (HUD). HANO's policy regarding public access is in strict accordance with the guidelines set forth in its Procurement Policy, Section 5.3.4, HUD Handbook 7460.8 REV 2, Section 1.6, Public Access to Procurement Information and Section 7.2 (J) Confidentiality. Furthermore, pursuant to Louisiana Revised Statute 40:526(8), HANO shall not disclose information submitted to HANO in confidence in response to this IFB, and not otherwise required by law to be submitted, where such information should reasonably be considered confidential.

Indemnification

The successful Respondent(s) will be required to protect, defend, indemnify, keep, save, and hold HANO, its officers, officials, employees and agents free and harmless from and against any and all liabilities, losses, penalties, damages, settlements, environmental liability, costs, charges, professional fees or other expenses or liabilities of every kind, nature and character arising out of or relating to any and all claims, liens, demands, obligations, actions, suits, judgments or settlements, proceedings or causes of action of every kind, nature and character (collectively, "claims") in connection with or arising directly or indirectly out of the acts or omissions and/or the performance thereof by the successful Respondent, its officers, officials, agents, employees, and subcontractors, including, but not limited to, the enforcement of the indemnification provision. The successful Respondent(s) will be further required to investigate, handle, respond to, provide defense for and defend all suits for any and all claims, at its sole expense and agrees to bear all other costs and expenses related thereto, even if the claims are considered groundless, false or fraudulent.

HANO will have the right, at its option and at its expense, to participate in the defense of any suit, without relieving the successful Respondent of any of its obligations under this indemnity provision. The indemnities to be set forth in the contract resulting from this IFB will survive the expiration or termination of that contract.

Rights, Use, and Ownership of Assessment Materials

Assessment materials generated as a result of performing the Scope of Services contained in this contract shall be confidential and proprietary and shall be for the exclusive use and ownership of The Housing Authority of New Orleans. Such materials shall include, but not be limited to data, cost estimates, and reports generated that contain descriptive and/or identifying information regarding individual properties owned by HANO and/or HANO's portfolio of properties. Such materials shall not be shared, signed, sold or disclosed to parties other than those named on the contract without the express written permission of the Housing Authority of New Orleans' Contracting Officer. Any violations of this provision shall be considered a breach of, and grounds for immediate termination in accordance with the General Contract Conditions, HUD Form 5370, Termination for Convenience and Default.

The selected Respondent shall abide by the applicable provisions of the Housing Authority of New Orleans' Ethics Policy and State of Louisiana Ethics Code.

Third Party Claims on Software

HANO shall be held harmless from any third-party legal claims involving the use by HANO of any software product or technique provided by the selected Respondent.

Licenses and Certifications

The successful Respondent shall possess all of the required State and Local licenses and certifications required to perform work of the type required by this contract in the City of New Orleans. In addition, the Respondent shall comply with all laws, ordinances and regulations applicable to the services contemplated herein. Respondents are presumed to be familiar with all federal, state and local laws, ordinances, codes, rules and regulations that may in any way affect the delivery of services.

The project shall be awarded only to contractors who are licensed under State of Louisiana Contractors License Law La. R.S. 37:2150-2192 with a major classification in Mechanical Construction.

Contractual Obligations

At any time, should the proposed services require the use of products or services of another company, such services shall be disclosed, and HANO will hold the selected respondent(s) responsible for the proposed services.

Certification of Legal Entity

Prior to execution of the Contract Agreement, the Respondent shall certify that joint ventures, partnerships, team agreements, new corporations or other entities that either exist or will be formally structured are, or will be legal and binding under Louisiana law.

Certifications

In submitting the bid, the Respondent is indicating a willingness to comply with all terms and conditions of the IFB, including but not limited to those set forth in HUD Form 5370, General Contract Conditions, Construction, and these Supplemental Conditions.

Personnel

In submitting their bids, Respondents are representing that the personnel described in their bids shall be available to perform the services described for the duration of the contract period, barring illness, accident or other unforeseeable events of a similar nature in which cases the Respondent must be able to provide a qualified replacement. Such representation shall be valid for a minimum of 120 calendar days after the bid due date and time. Furthermore, all personnel shall be considered to be, at all times, the sole employees of the Respondent under its sole direction, and not employees or agents of HANO.

Respondent Status

The successful Respondent will be held to be an independent Consultant and will not be an employee of HANO.

Assignment

The successful Respondent shall not enter into any subcontracts, retain consultants, or assign, transfer, convey, sublet, or otherwise delegate its obligations under the contract resulting from this IFB, or any of its rights, title or interest therein, or its power to execute such contract to any person, company or corporation without the prior written consent and approval of the HANO.

Advertising

In submitting a bid, the successful Respondent agrees not to use the results from it as a part of any commercial advertising. HANO does not permit law firms to advertise or promote the fact of their relationship with HANO in the course of marketing efforts, unless HANO specifically agrees otherwise.

Media Relations

The Contractor shall not make public comment on HANO matters without express written approval from HANO's Director of Communications. All media inquiries shall be referred to the Administrative Receiver and to the Director of Communications.

Assumption of Risk

Contractor is aware and acknowledges that HANO has no knowledge and/or duty to investigate the physical condition of any prospective property and/or the health conditions of any prospective property owners and/or occupants, including but not limited to tenants, subtenants, invitees, assignees, and/or any other person that has entered and/or lived in a prospective property. Contractor hereby agrees to assume any and all risk(s) associated with any potential infectious diseases, viruses, or the like, including but not limited to COVID-19 (Novel Coronavirus Disease), that may be present in a prospective property and/or a prospective property's owner(s) and/or occupant(s). Contractor agrees, acknowledges, and assumes all potential risks, including risk of infection, transmission, and/or contraction of any infectious disease, virus, and/or illness, to view and/or enter a prospective property. Contractor further agrees to hold harmless and release HANO, including any and all agents, assigns, and/or successors, from any and all liability and/or potential claims, whether from Contractor or third party, arising from and/or in any way related to Contractor's alleged infection, transmission, and/or contraction of any infectious disease, virus, and/or illness from a prospective property, except any claim and/or cause of action arising from HANO's gross negligence and/or willful misconduct.

Attachment G

HUD 5370



General Contract Conditions for Small Construction/Development Contracts

U.S. Department of Housing and Urban Development
Office of Public and Indian Housing
OMB Approval No. 2577-0157 (exp. 11/30/2023)

See Page 7 for Burden Statement

Applicability. The following contract clauses are applicable and must be inserted into **small construction/development contracts, greater than \$2,000 but not more than \$250,000.**

1. Definitions

Terms used in this form are the same as defined in form HUD-5370

2. Prohibition Against Liens

The Contractor is prohibited from placing a lien on the PHA's property. This prohibition shall apply to all subcontractors at any tier and all materials suppliers. The only liens on the PHA's property shall be the Declaration of Trust or other liens approved by HUD.

3. Disputes

- (a) Except for disputes arising under the **Labor Standards** clauses, all disputes arising under or relating to this contract, including any claims for damages for the alleged breach thereof which are not disposed of by agreement, shall be resolved under this clause.
- (b) All claims by the Contractor shall be made in writing and submitted to the Contracting Officer for a written decision. A claim by the PHA against the Contractor shall be subject to a written decision by the Contracting Officer.
- (c) The Contracting Officer shall, within 30 days after receipt of the request, decide the claim or notify the Contractor of the date by which the decision will be made.
- (d) The Contracting Officer's decision shall be final unless the Contractor (1) appeals in writing to a higher level in the PHA in accordance with the PHA's policy and procedures, (2) refers the appeal to an independent mediator or arbitrator, or (3) files suit in a court of competent jurisdiction. Such appeal must be made within 30 days after receipt of the Contracting Officer's decision.
- (e) The Contractor shall proceed diligently with performance of this contract, pending final resolution of any request for relief, claim, appeal, or action arising under or relating to the contract, and comply with any decision of the Contracting Officer.

4. Default

- (a) If the Contractor refuses or fails to prosecute the work, or any separable part thereof, with the diligence that will insure its completion within the time specified in this contract, or any extension thereof, or fails to complete said work within this time, the Contracting Officer may, by written notice to the Contractor, terminate the right to proceed with the work (or separable part of the work) that has been delayed. In the event, the PHA may take over the work and complete it by contract or otherwise, and may take possession of and use any materials, equipment, and plant on the work site necessary for completing the work. The Contractor and its sureties shall be liable for any damage to the PHA resulting from the Contractor's refusal or failure to complete the work within the specified time, whether or not the Contractor's right to proceed with the work is terminated. This liability includes any increased costs incurred

- (b) The Contractor's right to proceed shall not be terminated or the Contractor charged with damages under this clause if —
 - (1) The delay in completing the work arises from unforeseeable causes beyond the control and without the fault or negligence of the Contractor; and
 - (2) The Contractor, within 10 days from the beginning of such delay notifies the Contracting Officer in writing of the causes of delay. The Contracting Officer shall ascertain the facts and the extent of the delay. If, in the judgment of the Contracting Officer, the findings of Fact warrant such action, time for completing the work shall be extended by written modification to the contract. The findings of the Contracting Officer shall be reduced to a written decision which shall be subject to the provisions of the **Disputes** clause of this contract
- (c) If, after termination of the Contractor's right to proceed, it is determined that the Contractor was not in default, or that the delay was excusable, the rights and obligation of the parties will be the same as if the termination had been for convenience of the PHA.

5. Termination for Convenience

- (a) The Contracting Officer may terminate this contract in whole, or in part, whenever the Contracting Officer determines that such termination is in the best interest of the PHA. Any such termination shall be effected by delivery to the Contractor of a Notice of Termination specifying the extent to which the performance of the work under the contract is terminated, and the date upon which such termination becomes effective.
- (b) If the performance of the work is terminated, either in whole or in part, the PHA shall be liable to the Contractor for reasonable and proper costs resulting from such termination upon the receipt by the PHA of a properly presented claim setting out in detail: (1) the total cost of the work performed to date of termination less the total amount of contract payments made to the Contractor; (2) the cost (including reasonable profit) of settling and paying claims under subcontracts and material orders for work performed and materials and supplies delivered to the site, payment for which has not been made by the PHA to the Contractor or by the Contractor to the subcontractor or supplier; (3) the cost of preserving and protecting the work already performed until the PHA or assignee takes possession thereof or assumes responsibility therefore; (4) the actual or estimated cost of legal and accounting services reasonably necessary to prepare and present the termination claim to the PHA; and (5) an amount constituting a reasonable profit on the value of the work performed by the Contractor.
- (c) The Contracting Officer will act on the Contractor's claim within days (60 days unless otherwise indicated) of receipt of the Contractor's claim.
- (d) Any disputes with regard to this clause are expressly made subject to the provisions of the Disputes clause of this contract

6. Insurance

- (a) Before commencing work, the Contractor and each subcontractor shall furnish the PHA with certificates of insurance showing the following insurance is in force and will insure all operations under the Contract.

(1) Workers' Compensation, in accordance with state or Territorial Workers' Compensation laws.

(2) Commercial General Liability with a combined single limit for bodily injury and property damage of not less than \$ _____ [Contracting Officer insert amount] per occurrence to protect the Contractor and each subcontractor against claims for bodily injury or death and damage to the property of others. This shall cover the use of all equipment, hoists, and vehicles on the site(s) not covered by Automobile Liability under (3) below. If the Contractor has a "claims-made" policy, then the following additional requirements apply: the policy must provide a "retroactive date" which must be on or before the execution date of the Contract; and the extended reporting period may not be less than five years following the completion date of the Contract

(3) Automobile Liability on owned and non-owned motor vehicles used on the site(s) or in connection therewith for a combined single limit for bodily injury and property damage of not less than \$ _____ [Contracting Officer insert amount] per occurrence.

(b) Before commencing work, the Contractor shall furnish the PHA with a certificate of insurance evidencing that Builder's Risk (fire and extended coverage) Insurance on all work in place and/or materials stored at the building site(s), including foundations and building equipment, is in force. The Builder's Risk Insurance shall be for the benefit of the Contractor and the PHA as their interests may appear and each shall be named in the policy or policies as an insured. The Contractor in installing equipment supplied by the PHA shall carry insurance on such equipment from the time the Contractor takes possession thereof until the Contract work is accepted by the PHA. The Builder's Risk Insurance need not be carried on excavations, piers, footings, or foundations until such time as work on the superstructure is started. It need not be carried on landscape work. Policies shall furnish coverage at all times for the full cash value of all completed construction, as well as materials in place and/or stored at the site(s), whether or not partial payment has been made by the PHA. The Contractor may terminate this insurance on buildings as of the date taken over for occupancy by the PHA. The Contractor is not required to carry Builder's Risk Insurance for modernization work which does not involve structural alterations or additions and where the PHA's existing fire and extended coverage policy can be endorsed to include such work.

(c) All insurance shall be carried with companies which are financially responsible and admitted to do business in the State in which the project is located. If any such insurance is due to expire during the construction period, the Contractor (including subcontractors, as applicable) shall not permit the coverage to lapse and shall furnish evidence of coverage to the Contracting Officer. All certificates of insurance, as evidence of coverage, shall provide that no coverage may be canceled or non-renewed by the insurance company until at least 30 days prior written notice has been given to the Contracting Officer.

7. Contract Modifications

- (a) Only the Contracting Officer has authority to modify any term or condition of this contract. Any contract modification shall be authorized in writing.
- (b) The Contracting Officer may modify the contract unilaterally (1) pursuant to a specific authorization stated in a contract clause (e.g., Changes); or (2) for administrative matters which

do not change the rights or responsibilities of the parties (e.g., change in the PHA address). All other contract modifications shall be in the form of supplemental agreements signed by the Contractor and the Contracting Officer.

- (c) When a proposed modification requires the approval of HUD prior to its issuance (e.g., a change order that exceeds the PHA's approved threshold), such modification shall not be effective until the required approval is received by the PHA.

8. Changes

(a) The Contracting Officer may, at any time, without notice to the sureties, by written order designated or indicated to be a change order, make changes in the work within the general scope of the contract including changes:

(1) In the specifications (including drawings and designs);

(2) In the method or manner of performance of the work;

(3) PHA-furnished facilities, equipment, materials, services, or site; or,

(4) Directing the acceleration in the performance of the work (b) Any other written order or oral order (which, as used in this paragraph (b), includes direction, instruction, interpretation, or determination) from the Contracting Officer that causes a change shall be treated as a change order under this clause; provided, that the Contractor gives the Contracting Officer written notice stating (1) the date, circumstances and source of the order and (2) that the Contractor regards the order as a change order.

(c) Except as provided in this clause, no order, statement or conduct of the Contracting Officer shall be treated as a change under this clause or entitle the Contractor to an equitable adjustment.

(d) Many change under this clause causes an increase or decrease in the Contractor's cost of, or the time required for the performance of any part of the work under this contract, whether or not changed by any such order, the Contracting Officer shall make an equitable adjustment and modify the contract in writing. However, except for an adjustment based on defective specifications, no proposal for any change under paragraph (b) above shall be allowed for any costs incurred more than 20 days (5 days for oral orders) before the Contractor gives written notice as required. In the case of defective specifications for which the PHA is responsible, the equitable adjustment shall include any increased cost reasonably incurred by the Contractor in attempting to comply with the defective specifications.

(e) The Contractor must assert its right to an adjustment under this clause within 30 days after (1) receipt of a written change order under paragraph (a) of this clause, or (2) the furnishing of a written notice under paragraph (b) of this clause, by submitting a written statement describing the general nature and the amount of the proposal. If the facts justify it, the Contracting Officer may extend the period for submission. The proposal may be included in the notice required under paragraph (b) above. No proposal by the Contractor for an equitable adjustment shall be allowed if asserted after final payment under this contract

(f) The Contractor's written proposal for equitable adjustment shall be submitted in the form of a lump sum proposal supported with an itemized breakdown of all increases and decreases in the contract in at least the following details:

(1) Direct Costs. Materials (list individual items, the quantity and unit cost of each, and the aggregate cost); Transportation and delivery costs associated with materials; Labor

breakdowns by hours or unit costs (identified with specific work to be performed); Construction equipment exclusively necessary for the change; Costs of preparation and/ or revision to shop drawings resulting from the change; Worker's Compensation and Public Liability Insurance; Employment taxes under FICA and FUTA; and, Bond Costs - when size of change warrants revision.

- (2) Indirect Costs. Indirect costs may include overhead, general and administrative expenses, and fringe benefits not normally treated as direct costs.
- (3) Profit. The amount of profit shall be negotiated and may vary according to the nature, extent, and complexity of the work required by the change.

The allowability of the direct and indirect costs shall be determined in accordance with the Contract Cost Principles and Procedures for Commercial Firms in Part 31 of the Federal Acquisition Regulation (48 CFR 1-31), as implemented by HUD Handbook 2210.18, in effect on the date of this contract. The Contractor shall not be allowed a profit on the profit received by any subcontractor. Equitable adjustments for deleted work shall include a credit for profit and may include a credit for indirect costs. On proposals covering both increases and decreases in the amount of the contract, the application of indirect costs and profit shall be on the net-change in direct costs for the Contractor or subcontractor performing the work

- (g) The Contractor shall include in the proposal its request for time extension (if any), and shall include sufficient information and dates to demonstrate whether and to what extent the change will delay the completion of the contract in its entirety.
- (h) The Contracting Officer shall act on proposals within 30 days after their receipt, or notify the Contractor of the date when such action will be taken.
- (i) Failure to reach an agreement on any proposal shall be a dispute under the clause entitled Disputes herein. Nothing in this clause, however, shall excuse the Contractor from proceeding with the contract as changed.
- (j) Except in an emergency endangering life or property, no change shall be made by the Contractor without a prior order from the Contracting Officer.

9. Examination and Retention of Contractor's Records

The HA, HUD, or Comptroller General of the United States, or any of their duly authorized representatives shall, until three years after final payment under this contract, have access to and the right to examine any of the Contractor's directly pertinent books, documents, papers, or other records involving transactions related to this contract for the purpose of making audit, examination, excerpts, and transcriptions.

10. Rights in Data and Patent Rights (Ownership and Proprietary Interest)

The HA shall have exclusive ownership of, all proprietary interest in, and the right to full and exclusive possession of all information, materials, and documents discovered or produced by Contractor pursuant to the terms of this Contract, including but not limited to reports, memoranda or letters concerning the research and reporting tasks of this Contract.

11. Energy Efficiency

The Contractor shall comply with all mandatory standards and policies relating to energy efficiency which are contained in the energy conservation plan issued in compliance with the Energy Policy and Conservation Act (Pub.L. 94-163) for the State in which the work under this contract is performed.

12. Procurement of Recovered Materials

- (a) In accordance with Section 6002 of the Solid Waste Disposal Act, as amended by the Resource Conservation and Recovery Act, the Contractor shall procure items designated in guidelines of the Environmental Protection Agency (EPA) at 40 CFR Part 247 that contain the highest percentage of recovered materials practicable, consistent with maintaining a satisfactory level of competition. The Contractor shall procure items designated in the EPA guidelines that contain the highest percentage of recovered materials practicable unless the Contractor determines that such items: (1) are not reasonably available in a reasonable period of time; (2) fail to meet reasonable performance standards, which shall be determined on the basis of the guidelines of the National Institute of Standards and Technology, if applicable to the item; or (3) are only available at an unreasonable price.
- (b) Paragraph (a) of this clause shall apply to items purchased under this contract where: (1) the Contractor purchases in excess of \$10,000 of the item under this contract; or (2) during the preceding Federal fiscal year, the Contractor: (i) purchased any amount of the items for use under a contract that was funded with Federal appropriations and was with a Federal agency or a State agency or agency of a political subdivision of a State; and (ii) purchased a total of in excess of \$10,000 of the item both under and outside that contract

13. Training and Employment Opportunities for Residents in the Project Area (Section 3, HUD Act of 1968; 24 CFR 75)

- (a) The work to be performed under this contract is subject to the requirements of section 3 of the Housing and Urban Development Act of 1968, as amended, 12 U.S.C. 1701u (section 3). The purpose of section 3 is to ensure that employment and other economic opportunities generated by HUD assistance or HUD-assisted projects covered by section 3, shall, to the greatest extent feasible, be directed to low- and very low-income persons, particularly persons who are recipients of HUD assistance for housing.
- (b) The parties to this contract agree to comply with HUD's regulations in 24 CFR Part 75, which implement section 3. As evidenced by their execution of this contract, the parties to this contract certify that they are under no contractual or other impediment that would prevent them from complying with the Part 75 regulations.
- (c) The contractor agrees to send to each labor organization or representative of workers with which the contractor has a collective bargaining agreement or other understanding, if any, a notice advising the labor organization or workers' representative of the contractor's commitments under this section 3 clause, and will post copies of the notice in conspicuous places at the work site where both employees and applicants for training and employment positions can see the notice. The notice shall describe the section 3 prioritization requirements, and shall state the minimum percentages of labor hour requirements established in the Benchmark Notice (FR-6085-N-04).

- (d) The contractor agrees to include this section 3 clause in every subcontract subject to compliance with regulations in 24 CFR Part 75, and agrees to take appropriate action, as provided in an applicable provision of the subcontract or in this section 3 clause, upon a finding that the subcontractor is in violation of the regulations in 24 CFR Part 75. The contractor will not subcontract with any subcontractor where the contractor has notice or knowledge that the subcontractor has been found in violation of the regulations in 24 CFR Part 75.
- (e) Noncompliance with HUD's regulations in 24 CFR Part 75 may result in sanctions, termination of this contract for default, and debarment or suspension from future HUD assisted contracts.
- (f) Contracts, subcontracts, grants, or subgrants subject to Section 7(b) of the Indian Self-Determination and Education Assistance Act (25 U.S.C. 5307(b)) or subject to tribal preference requirements as authorized under 101(k) of the Native American Housing Assistance and Self-Determination Act (25 U.S.C. 4111(k)) must provide preferences in employment, training, and business opportunities to Indians and Indian organizations, and are therefore not subject to the requirements of 24 CFR Part 75.

14. Labor Standards - Davis-Bacon and Related Acts

(a) Minimum Wages.

(1) All laborers and mechanics employed under this contract in the construction or development of the project(s) involved will be paid unconditionally and not less often than once a week, and without subsequent deduction or rebate on any account (except such payroll deductions as are permitted by regulations issued by the Secretary of Labor under the Copeland Act (29 CFR Part 3)), the full amount of wages and bona fide fringe benefits (or cash equivalents thereof) due at time of payment computed at rates not less than those contained in the wage determination of the Secretary of Labor which is attached hereto and made a part hereof, regardless of any contractual relationship which may be alleged to exist between the Contractor and such laborers and mechanics. Contributions made or costs reasonably anticipated for bona fide fringe benefits under Section 1(b)(2) of the Davis-Bacon Act on behalf of laborers or mechanics are considered wages paid to such laborers or mechanics, subject to the provisions of 29 CFR 5.5(a)(1)(iv); also, regular contributions made or costs incurred for more than a weekly period (but not less often than quarterly) under plans, funds, or programs which cover the regular weekly period, are deemed to be constructively made or incurred during such weekly period. Such laborers and mechanics shall be paid the appropriate wage rate and fringe benefits in the wage determination for the classification of work actually performed, without regard to skill, except as provided in 29 CFR 5.5(a)(4). Laborers or mechanics performing work in more than one classification may be compensated at the rate specified for each classification for the time actually worked therein; provided, that the employer's payroll records accurately set forth the time spent in each classification in which work is performed. The wage determination (including any additional classification and wage rates conformed under 29 CFR 5.5(a)(1)(ii) and the Davis-Bacon poster (WH-1321) shall be posted at all times by the Contractor and its subcontractors at the site of the work in

a prominent and accessible place where it can be easily seen by the workers.

- (2) (i) Any class of laborers or mechanics, including helpers, which is not listed in the wage determination and which is to be employed under the contract shall be classified in conformance with the wage determination. HUD shall approve an additional classification and wage rate and fringe benefits therefor only when all the following criteria have been met:
 - (a) The work to be performed by the classification requested is not performed by a classification in the wage determination; and
 - (b) The classification is utilized in the area by the construction industry; and
 - (c) The proposed wage rate, including any bona fide fringe benefits, bears a reasonable relationship to the wage rates contained in the wage determination.
- (ii) If the Contractor and the laborers and mechanics to be employed in the classification (if known), or their representatives, and HUD or its designee agree on the classification and wage rate (including the amount designated for fringe benefits where appropriate), a report of the action shall be sent by HUD or its designee to the Administrator of the Wage and Hour Division, Employee Standards Administration, U.S. Department of Labor, Washington, DC 20210. The Administrator, or an authorized representative, will approve, modify, or disapprove every additional classification action within 30 days of receipt and so advise HUD or its designee or will notify HUD or its designee within the 30-day period that additional time is necessary.
- (iii) In the event the Contractor, the laborers or mechanics to be employed in the classification or their representatives, and HUD or its designee do not agree on the proposed classification and wage rate (including the amount designated for fringe benefits, where appropriate), HUD or its designee shall refer the questions, including the views of all interested parties and the recommendation of HUD or its designee, to the Administrator of the Wage and Hour Division for determination. The Administrator, or an authorized representative, will issue a determination within 30 days of receipt and so advise HUD or its designee or will notify HUD or its designee within the 30-day period that additional time is necessary.
- (iv) The wage rate (including fringe benefits where appropriate) determined pursuant to subparagraphs (a)(2)(ii) or (iii) of this clause shall be paid to all workers performing work in the classification under this contract from the first day on which work is performed in the classification.
- (3) Whenever the minimum wage rate prescribed in the contract for a class of laborers or mechanics includes a fringe benefit which is not expressed as an hourly rate, the Contractor shall either pay the benefit as stated in the wage determination or shall pay another bona fide fringe benefit or an hourly cash equivalent thereof.
- (4) If the Contractor does not make payments to a trustee or other third person, the Contractor may consider as part

of the wages of any laborer or mechanic the amount of any costs reasonably anticipated in providing bona fide fringe benefits under a plan or program; *provided*, that the Secretary of Labor has found, upon the written request of the Contractor, that the applicable standards of the Davis-Bacon Act have been met. The Secretary of Labor may require the Contractor to set aside in a separate account assets for the meeting of obligations under the plan or program.

(b) Withholding of Funds. HUD or its designee shall, upon its own action or upon written request of an authorized representative of the Department of Labor, withhold or cause to be withheld from the Contractor under this contract or any other Federal contract with the same prime Contractor, or any other Federally-assisted contract subject to Davis-Bacon prevailing wage requirements, which is held by the same prime Contractor, so much of the accrued payments or advances as may be considered necessary to pay laborers and mechanics, including apprentices, trainees, and helpers, employed by the Contractor or any subcontractor the full amount of wages required by the contract. In the event of failure to pay any laborer or mechanic, including any apprentice, trainee, or helper, employed or working in the construction or development of the project, all or part of the wages required by the contract, HUD or its designee may, after written notice to the Contractor, take such action as may be necessary to cause the suspension of any further payment, advance, or guarantee of funds until such violations have ceased. HUD or its designee may, after written notice to the Contractor, disburse such amounts withheld for and on account of the Contractor or subcontractor to the respective employees to whom they are due.

(c) Payrolls and Basic Records.

(1) Payrolls and basic records relating thereto shall be maintained by the Contractor during the course of the work and preserved for a period of three years thereafter for all laborers and mechanics working in the construction or development of the project. Such records shall contain the name, address, and social security number of each such worker, his or her correct classification, hourly rates of wages paid (including rates of contributions or costs anticipated for bona fide fringe benefits or cash equivalents thereof of the types described in section 1(b)(2)(B) of the Davis-Bacon Act), daily and weekly number of hours worked, deductions made, and actual wages paid. Whenever the Secretary of Labor has found, under 29 CFR 5.5(a)(1)(iv), that the wages of any laborer or mechanic include the amount of costs reasonably anticipated in providing benefits under a plan or program described in section 1(b)(2)(B) of the Davis-Bacon Act, the Contractor shall maintain records which show that the commitment to provide such benefits is enforceable, that the plan or program is financially responsible, and that the plan or program has been communicated in writing to the laborers or mechanics affected, and records which show the costs anticipated or the actual cost incurred in providing such benefits. Contractors employing apprentices or trainees under approved programs shall maintain written evidence of

the registration of apprenticeship programs and certification of trainee programs, the registration of the apprentices and trainees, and the ratios and wage rates prescribed in the applicable programs.

- (2) (i) The Contractor shall submit weekly for each week in which any contract work is performed a copy of all payrolls to the Contracting Officer for transmission to HUD or its designee. The payrolls submitted shall set out accurately and completely all of the information required to be maintained under subparagraph (c)(1) of this clause. This information may be submitted in any form desired. Optional Form WH-347 (Federal Stock Number 029-005-00014-1) is available for this purpose and may be purchased from the Superintendent of Documents, U.S. Government Printing Office, Washington, D.C. 20402. The prime Contractor is responsible for the submission of copies of payrolls by all subcontractors. (Approved by the Office of Management and Budget under OMB Control Number 1214-0149.)
- (ii) Each payroll submitted shall be accompanied by a "Statement of Compliance," signed by the contractor or subcontractor or his or her agent who pays or supervises the payment of the persons employed under the contract and shall certify the following:
- (A) That the payroll for the payroll period contains the information required to be maintained under paragraph (c)(1) of this clause and that such information is correct and complete;
- (B) That each laborer or mechanic (including each helper, apprentice, and trainee) employed on the contract during the payroll period has been paid the full weekly wages earned, without rebate, either directly or indirectly, and that no deductions have been made either directly or indirectly from the full wages earned, other than permissible deductions as set forth in 29 CFR Part 3; and
- (C) That each laborer or mechanic has been paid not less than the applicable wage rates and fringe benefits or cash equivalents for the classification of work performed, as specified in the applicable wage determination incorporated into the contract
- (iii) The weekly submission of a properly executed certification set forth on the reverse side of Optional Form WH-347 shall satisfy the requirements for submission of the "Statement of Compliance" required by subparagraph (c)(2)(ii) of this clause.
- (iv) The falsification of any of the above certifications may subject the Contractor or subcontractor to civil or criminal prosecution under Section 1001 of Title 18 and Section 3729 of Title 31 of the United States Code.
- (3) The Contractor or subcontractor shall make the records required under subparagraph (c)(1) available for inspection, copying, or transcription by authorized representatives of HUD or its designee, the Contracting Officer, or the Department of Labor and shall permit such representatives to interview employees during working hours on the job. If the Contractor or subcontractor fails to submit the required records or to make them available, HUD or its designee may, after written notice to the Contractor, take such action as may be necessary to cause the suspension of any further payment, advance, or guarantee of funds. Furthermore, failure to submit the required records upon request or to make such records available may be grounds for debarment action pursuant to 29 CFR 5.12.

- (d) Apprentices. Apprentices will be permitted to work at less than the predetermined rate for the work they performed when they are employed pursuant to and individually registered in a bona fide apprenticeship program registered with the U.S. Department of Labor, Employment and Training Administration, Office of Apprenticeship Training, Employer and Labor Services (OATELS), or with a State Apprenticeship Agency recognized by OATELS, or if a person is employed in his or her first 90 days of probationary employment as an apprentice in such an apprenticeship program, who is not individually registered in the program, but who has been certified by OATELS or a State Apprenticeship Agency (where appropriate) to be eligible for probationary employment as an apprentice.

The allowable ratio of apprentices to journeymen on the job site in any craft classification shall not be greater than the ratio permitted to the Contractor as to the entire work force under the registered program. Any worker listed on a payroll at an apprentice wage rate, who is not registered or otherwise employed as stated in this paragraph, shall be paid not less than the applicable wage rate on the wage determination for the classification of work actually performed. In addition, any apprentice performing work on the job site in excess of the ratio permitted under the registered program shall be paid not less than the applicable wage rate on the wage determination for the work actually performed. Where a contractor is performing construction on a project in a locality other than that in which its program is registered, the ratios and wage rates (expressed in percentages of the journeyman's hourly rate) specified in the Contractor's or subcontractor's registered program shall be observed. Every apprentice must be paid at not less than the rate specified in the registered program for the apprentice's level of progress, expressed as a percentage of the journeyman hourly rate specified in the applicable wage determination. Apprentices shall be paid fringe benefits in accordance with the provisions of the apprenticeship program. If the apprenticeship program does not specify fringe benefits, apprentices must be paid the full amount of fringe benefits listed on the wage determination for the applicable classification. If the Administrator of the Wage and Hour Division determines that a different practice prevails for the applicable apprentice classification, fringes shall be paid in accordance with that determination. In the event OATELS, or a State Apprenticeship Agency recognized by OATELS, withdraws approval of an apprenticeship program, the Contractor will no longer be permitted to utilize apprentices at less than the applicable predetermined rate for the work performed until an acceptable program is approved.

- (e) Trainees. Except as provided in 29 CFR 5.16, trainees will not be permitted to work at less than the predetermined rate for the work performed unless they are employed pursuant to and individually registered in a program which has received prior approval, evidenced by formal certification by the U.S. Department of Labor, Employment and Training Administration. The ratio of trainees to journeymen on the job site shall not be greater than permitted under the plan approved by the Employment and Training Administration. Every trainee must be paid at not less than the rate specified in the approved program for the trainee's level of progress, expressed as a percentage of the journeyman hourly rate

specified in the applicable wage determination. Trainees shall be paid fringe benefits in accordance with the provisions of the trainee program. If the trainee program does not mention fringe benefits, trainees shall be paid the full amount of fringe benefits listed in the wage determination unless the Administrator of the Wage and Hour Division determines that there is an apprenticeship program associated with the corresponding journeyman wage rate in the wage determination which provides for less than full fringe benefits for apprentices. Any employee listed on the payroll at a trainee rate who is not registered and participating in a training plan approved by the Employment and Training Administration shall be paid not less than the applicable wage rate in the wage determination for the classification of work actually performed. In addition, any trainee performing work on the job site in excess of the ratio permitted under the registered program shall be paid not less than the applicable wage rate in the wage determination for the work actually performed. In the event the Employment and Training Administration withdraws approval of a training program, the Contractor will no longer be permitted to utilize trainees at less than the applicable predetermined rate for the work performed until an acceptable program is approved.

- (f) Equal Employment Opportunity. The utilization of apprentices, trainees, and journeymen under this clause shall be in conformity with the equal employment opportunity requirements of Executive Order 11246, as amended, and 29 CFR Part 30.
- (g) Compliance with Copeland Act Requirements. The Contractor shall comply with the requirements of 29 CFR Part 3, which are hereby incorporated by reference in this contract
- (h) Contract Termination; Debarment. A breach of the labor standards clauses in this contract may be grounds for termination of the contract and for debarment as a Contractor and a subcontractor as provided in 29 CFR 5.12.
- (i) Compliance with Davis-Bacon and related Act Requirements. All rulings and interpretations of the Davis-Bacon and related Acts contained in 29 CFR Parts 1, 3, and 5 are herein incorporated by reference in this contract
- (j) Disputes Concerning Labor Standards. Disputes arising out of the labor standards provisions of this clause shall not be subject to the general disputes clause of this contract. Such disputes shall be resolved in accordance with the procedures of the Department of Labor set forth in 29 CFR Parts 5, 6, and 7. Disputes within the meaning of this clause include disputes between the Contractor (or any of its subcontractors) and the PHA, HUD, the U.S. Department of Labor, or the employees or their representatives.
- (k) Certification of Eligibility.
- (1) By entering into this contract, the Contractor certifies that neither it (nor he or she) nor any person or firm who has an interest in the Contractor's firm is a person or firm ineligible to be awarded contracts by the United States Government by virtue of section 3(a) of the Davis-Bacon Act or 29 CFR 5.12(a)(1).
- (2) No part of this contract shall be subcontracted to any person or firm ineligible for award of a United States Government

contract by virtue of section 3(a) of the Davis-Bacon Act or 29 CFR 5.12(a)(1).

(3) The penalty for making false statements is prescribed in the U. S. Criminal Code, 18 U.S.C. 1001.

(1) Subcontracts. The Contractor or subcontractor shall insert in any subcontracts all the provisions contained in this clause, and such other clauses as HUD or its designee may by appropriate instructions require, and also a clause requiring the subcontractors to include these provisions in any lower tier subcontracts. The prime Contractor shall be responsible for the compliance by any subcontractor or lower tier subcontractor with all these provisions.

(m) Non-Federal Prevailing Wage Rates. Any prevailing wage rate (including basic hourly rate and any fringe benefits), determined under State law to be prevailing, with respect to any employee in any trade or position employed under the contract, is inapplicable to the contract and shall not be enforced against the Contractor or any subcontractor, with respect to employees engaged under the contract whenever such non-Federal prevailing wage rate exceeds:

- (i) the applicable wage rate determined by the Secretary of Labor pursuant to the Davis-Bacon Act (40 U.S.C. 3141 et seq.) to be prevailing in the locality with respect to such trade;
- (ii) an applicable apprentice wage rate based thereon specified in an apprenticeship program registered with the U.S. Department of Labor (DOL) or a DOL-recognized State Apprenticeship Agency; or
- (iii) an applicable trainee wage rate based thereon specified in a DOL-certified trainee program.

Public reporting burden for this collection of information is estimated to average 1 hour. This includes the time for collecting, reviewing, and reporting the data. The information requested is required to obtain a benefit. This form includes those clauses required by OMB's common rule on grantee procurement, implemented at HUD in 2 CFR 200, and those requirements set forth in Section 3 of the Housing and Urban Development Act of 1968 and its amendment by the Housing and Community Development Act of 1992, implemented by HUD at 24 CFR Part 7575. The form is required for construction contracts awarded by Public Housing Agencies (PHAs). The form is used by Housing Authorities in so licitations to provide necessary contract clauses. If the form were not used, PHAs would be unable to enforce their contracts.. There are no assurances of confidentiality. HUD may not conduct or sponsor, and an applicant is not required to respond to a collection of information unless it displays a currently valid OMB control number.

Attachment H Acknowledgment of Addenda



**ACKNOWLEDGEMENT OF
ADDENDA (ATTACHMENT H)**

Respondent has received the following Addenda, receipt of which is hereby acknowledged:

Addendum Number: _____ Date Received: _____

Addendum Number: _____ Date Received: _____

Addendum Number: _____ Date Received: _____

Addendum Number: _____ Date Received: _____

(Company Name)

(Signature)

(Printed or Typed Name)

Attachment I
LOUISIANA UNIFORM
PUBLIC WORK BID
FORM
(Entry of Proposed Fees)



LOUISIANA UNIFORM PUBLIC WORK BID FORM

**TO: HOUSING AUTHORITY OF NEW ORLEANS
PROUREMENT AND CONTRACTS DEPT.
4100 TOURO STREET, NEW ORLEANS, LA**

(Owner to provide name and address of owner)

**BID FOR: WATER SOFTENER SYSTEM FOR
GUSTE HIGH RISE
IFB #23-912-41**

(Owner to provide name of project and other identifying information)

The undersigned bidder hereby declares and represents that she/he; a) has carefully examined and understands the Bidding Documents, b) has not received, relied on, or based his bid on any verbal instructions contrary to the Bidding Documents or any addenda, c) has personally inspected and is familiar with the project site, and hereby proposes to provide all labor, materials, tools, appliances and facilities as required to perform, in a workmanlike manner, all work and services for the construction and completion of the referenced project, all in strict accordance with the Bidding Documents prepared by: the Housing Authority of New Orleans and dated: July 14, 2023

(Bidder to provide name of entity preparing bidding documents.)

Bidders must acknowledge all addenda. The Bidder acknowledges receipt of the following **ADDENDA:** (Enter the number the Designer has assigned to each of the addenda that the Bidder is acknowledging) _____.

TOTAL BASE BID: For all work required by the Bidding Documents (including any and all unit prices designated "Base Bid" * but not alternates) the sum of:

_____ Dollars (\$ _____)

ALTERNATES: For any and all work required by the Bidding Documents for Alternates including any and all unit prices designated as alternates in the unit price description.

Alternate No. 1 *(Owner to provide description of alternate and state whether add or deduct)* for the lump sum of:

N/A _____ Dollars (\$ _____)

Alternate No. 2 *(Owner to provide description of alternate and state whether add or deduct)* for the lump sum of:

N/A _____ Dollars (\$ _____)

Alternate No. 3 *(Owner to provide description of alternate and state whether add or deduct)* for the lump sum of:

N/A _____ Dollars (\$ _____)

NAME OF BIDDER: _____

ADDRESS OF BIDDER: _____

LOUISIANA CONTRACTOR'S LICENSE NUMBER: _____

NAME OF AUTHORIZED SIGNATORY OF BIDDER: _____

TITLE OF AUTHORIZED SIGNATORY OF BIDDER: _____

SIGNATURE OF AUTHORIZED SIGNATORY OF BIDDER **: _____

DATE: _____

THE FOLLOWING ITEMS ARE TO BE INCLUDED WITH THE SUBMISSION OF THIS LOUISIANA UNIFORM PUBLIC WORK BID FORM:

* The Unit Price Form shall be used if the contract includes unit prices. Otherwise it is not required and need not be included with the form. The number of unit prices that may be included is not limited and additional sheets may be included if needed.

** **A CORPORATE RESOLUTION OR WRITTEN EVIDENCE** of authority of the person signing the bid for the public work as prescribed by LA R.S.38:2212(B)(5).

BID SECURITY in the form of a bid bond, certified check or cashier's check as prescribed by LA RS 38:2218.A is attached to and made a part of this bid.

Attachment J Certification of Contractor Non- Exclusion



CERTIFICATION OF CONTRACTOR NON-EXCLUSION

This certification applies to a sole proprietor or any bidding entity or any individual partner, incorporator, director, manager, officer, organizer, or member, who has at least 10% ownership in the bidding entity, for consideration for award of contracts, in accordance with LA R.S. 38:2227.

A conviction of or plea of guilty or no contest to the following state crimes or equivalent federal crimes shall permanently bar any person or the bidding entity from bidding on public projects:

- (a) Public bribery
- (b) Corrupt Influencing
- (c) Extortion
- (d) Money laundering

A conviction of or plea of guilty or no contest to the following state crimes or equivalent federal crimes shall bar any person or the bidding entity from bidding on public projects for a period of five years from the date of conviction or from the date of the entrance of the plea of guilty or no contest:

- (a) Theft
- (b) Identity theft
- (c) Theft of a business record
- (d) False accounting
- (e) Issuing worthless checks
- (f) Bank fraud
- (g) Forgery
- (h) Contractors; misapplication of payments
- (i) Malfeasance in office

The five-year prohibition shall apply only if the crime was committed during the solicitation or execution of a contract or bid awarded pursuant to the provisions of LA R.S. Title 38, Chapter 10 – Public Contracts.

Should information be discovered about a bidding entity that would be cause for debarment, suspension, exclusion, or determination of ineligibility for award of a contract, HANO shall report and submit supporting documentation to the applicable regulatory agency.

I hereby attest that I have not been convicted of, or have not entered a plea of guilty or nolo contendere to any of the crimes listed above or equivalent crimes.

(Print)

(Date)

(Signature)

Attachment K E-Verification Affidavit

(Only required post-bid by awarded
bidder)



E-VERIFICATION AFFIDAVIT

(Employer)

STATE OF _____

CITY/COUNTY OF _____

I, _____ Being duly sworn, attests and says that:
(Authorized Signatory)

_____ a private organization,
(Name of Private Company/Employer)

duly registered in the aforementioned state, and contracted to perform work within the State of Louisiana, herein attests that I/we (the employer) are in compliance with the United States Department of Homeland Security's "E-Verify" program, which is mandated pursuant to La RS 38:2212.10. I further attest that I/we are registered in a status verification system to verify that all new employees in my/our (the employer) employ are legal citizens of the United States, or are legal aliens. Further, I/we shall continue to utilize a status verification system to confirm the legal status of all new employees assigned to this project during the term of this contract. In further compliance with the Immigration Reform and Immigrant Responsibility Act of 1996 administrated by the U.S. Department of Homeland Security, I/we shall require all subcontractors to submit to me/us (the employer) a sworn affidavit verifying its compliance with the Immigration Reform and Immigrant Responsibility Act of 1996, 8 U.S.C. 1324(a).

Signature of

(Authorized Signatory)

(Printed Name/Title of Authorized Signatory)

Sworn to and Subscribed before me:

This _____ day of _____, 20_____.

Notary Public

My Commission Expires _____

Attachment L Vendor Registration Form





VENDOR SETUP FORM

Company Name: _____

Physical Address: _____

City: _____ State: _____ Zip: _____

Owner/President: _____

Remit To Address: _____

City: _____ State: _____ Zip: _____

Contact Name: _____ Authorized Signature: _____

Contact Number: _____ Contact Fax: _____

Contact Email: _____ Company Website: _____

Banking Information (Required for EFT Payment, if applicable):

Bank Name: _____ Name on Bank Account: _____

Routing Number:

Account Number:

Type of Account: Checking Savings Corporate/Commercial

Required: Taxpayer Identification Number: _____

Type of Operation (Check all that apply):

- Individual Corporation Manufacturer Partnership Distributor
- Sole Proprietorship Retail Dealer Agent/Broker Limited Liability

PLEASE ATTACH ANY REVISED INFORMATION INCLUDING W9 AND/OR BANKING UPDATED INFORMATION, AS REQUIRED.....

Requisition #: _____ or N/A _____ (Direct pay items do not require a requisition #)

Approvals:

Requestor/Department: _____ Date: _____

Finance Approval: _____ Date: _____ 1099? Y N

Procurement Approval: _____ Date: _____

Date Entered: _____ Entered By: _____

* Attach Documentation (If Provided)

Select All Applicable Products/Service in Each Category:

Voice Services & Products:

- Call Accounting
- Calling Cards
- Local Services
- Voice Bridging
- VoIP Solutions
- Call Center
- Telephone Equipment
- Long Distance Services
- Voice Systems
- Wireless/Cellular
- Other: _____
- Other: _____

Network/Internet Services & Products:

- Converged Network Provider
- Internet Access
- Virtual Learning
- Custom Network/Internet Solutions
- Network Equipment
- Wireless LAN/MAN/WAN
- Other: _____
- Other: _____

Video Services & Products:

- Audio/Visual Equipment
- Interactive Video & Multimedia Equipment
- Video Bridging
- Integration Services
- Network Access
- Other: _____
- Other: _____

e-Learning Solutions:

- Course/Learning Management Application
- Training/Certification
- Course Content Provider
- Hosting – ASP Services
- Other: _____
- Other: _____

Computer Services & Products:

- Application Software (Microsoft, Adobe, Lotus, etc.)
- E-mail Applications
- Network Devices
- SAN, Enterprise, Etc.
- Web & Application Hosting/IT Services
- Computers, Servers & Add-On Components
- Internet Content Filtering Applications & Devices
- Peripheral Equipment
- Storage Systems
- Other: _____
- Other: _____

Additional Services & Products:

- Auditors
- Electrical Generators & Power Suppression Equip
- Office Furniture
- Consulting
- Library Supplies, Equipment & Furniture
- Office Supplies & Equipment
- Other: _____
- Other: _____
- Other: _____

Circle all that Apply: (DBE) (WBE) (MBE) (Section 3) (Small Business)

Required: (Attach a copy of your certification for all items circled above)

Check one: __ African American __ Hispanic __ Native American __ Asian __ Caucasian __ Other

Definitions:

Disadvantage Business Enterprise (DBE) – A business enterprise that is 51% or more owned, controlled, and actively operated by one or more persons who are classified as members of a racial minority group, such as African American, Hispanic American, Asian Pacific American, Asian Indian American, Native American, Aleuts or Hasidic Jewish Americans.

Woman Business Enterprise (WBE) - A business enterprise that is 51% or more owned, controlled, and actively operated by one or more women.

Section 3 Business - A business that meets one of the following:

1. 51% or more owned and controlled by a resident of any HANO Housing site or whose full-time permanent workforce includes 30% of HANO residents of any housing site;
2. Hud Youthbuild Program in Orleans Parish;
3. Business concerns that are 51% or more owned and controlled by HANO residents or are low or very low-income Orleans Parish Residents or whose full-time permanent workforce includes 30% of HANO residents or low/very low-income Orleans Parish residents;
4. Business that subcontracts in excess of 25% of the total amount of subcontracts to business concerns identified in the preferences above.

Small Business Enterprise (SBE) — A business concern, including its affiliates, that is independently owned and operated and is not dominant in the field of operation for which it is bidding and qualifies as a small business under the criteria and size standards in 13 CFR Part 121 (see FAR 19.102).

DECLARATION BY VENDOR

I confirm that:

- i) Neither I nor any employee of _____ is in any way connected to the Housing Authority of New Orleans or its employees or an immediate family member of any Housing Authority of New Orleans employee.
- ii) For each relationship, I will include a brief statement describing the relationship.
- iii) The information furnished is correct to the best of my knowledge and belief.

Printed Name of Authorized Signatory

Signature

Request for Taxpayer Identification Number and Certification

**Give Form to the
requester. Do not
send to the IRS.**

▶ Go to www.irs.gov/FormW9 for instructions and the latest information.

Print or type. See Specific Instructions on page 3.	<p>1 Name (as shown on your income tax return). Name is required on this line; do not leave this line blank.</p> <hr/> <p>2 Business name/disregarded entity name, if different from above</p> <hr/> <p>3 Check appropriate box for federal tax classification of the person whose name is entered on line 1. Check only one of the following seven boxes.</p> <p><input type="checkbox"/> Individual/sole proprietor or single-member LLC <input type="checkbox"/> C Corporation <input type="checkbox"/> S Corporation <input type="checkbox"/> Partnership <input type="checkbox"/> Trust/estate</p> <p><input type="checkbox"/> Limited liability company. Enter the tax classification (C=C corporation, S=S corporation, P=Partnership) ▶ _____</p> <p>Note: Check the appropriate box in the line above for the tax classification of the single-member owner. Do not check LLC if the LLC is classified as a single-member LLC that is disregarded from the owner unless the owner of the LLC is another LLC that is not disregarded from the owner for U.S. federal tax purposes. Otherwise, a single-member LLC that is disregarded from the owner should check the appropriate box for the tax classification of its owner.</p> <p><input type="checkbox"/> Other (see instructions) ▶ _____</p>	<p>4 Exemptions (codes apply only to certain entities, not individuals; see instructions on page 3):</p> <p>Exempt payee code (if any) _____</p> <p>Exemption from FATCA reporting code (if any) _____</p> <p><small>(Applies to accounts maintained outside the U.S.)</small></p>
	<p>5 Address (number, street, and apt. or suite no.) See instructions.</p> <hr/> <p>6 City, state, and ZIP code</p> <hr/> <p>7 List account number(s) here (optional)</p>	<p>Requester's name and address (optional)</p> <hr/>

Part I Taxpayer Identification Number (TIN)

Enter your TIN in the appropriate box. The TIN provided must match the name given on line 1 to avoid backup withholding. For individuals, this is generally your social security number (SSN). However, for a resident alien, sole proprietor, or disregarded entity, see the instructions for Part I, later. For other entities, it is your employer identification number (EIN). If you do not have a number, see *How to get a TIN*, later.

Note: If the account is in more than one name, see the instructions for line 1. Also see *What Name and Number To Give the Requester* for guidelines on whose number to enter.

Social security number								
<table style="width: 100%; border-collapse: collapse;"> <tr> <td style="width: 25%; border: 1px solid black; height: 20px;"></td> <td style="width: 25%; border: 1px solid black; height: 20px;"></td> <td style="width: 25%; border: 1px solid black; height: 20px;"></td> <td style="width: 25%; border: 1px solid black; height: 20px;"></td> </tr> <tr> <td style="text-align: center;">-</td> <td style="text-align: center;">-</td> <td></td> <td></td> </tr> </table>					-	-		
-	-							
or								
Employer identification number								
<table style="width: 100%; border-collapse: collapse;"> <tr> <td style="width: 25%; border: 1px solid black; height: 20px;"></td> <td style="width: 25%; border: 1px solid black; height: 20px;"></td> <td style="width: 25%; border: 1px solid black; height: 20px;"></td> <td style="width: 25%; border: 1px solid black; height: 20px;"></td> </tr> <tr> <td style="text-align: center;">-</td> <td style="text-align: center;">-</td> <td></td> <td></td> </tr> </table>					-	-		
-	-							

Part II Certification

Under penalties of perjury, I certify that:

1. The number shown on this form is my correct taxpayer identification number (or I am waiting for a number to be issued to me); and
2. I am not subject to backup withholding because: (a) I am exempt from backup withholding, or (b) I have not been notified by the Internal Revenue Service (IRS) that I am subject to backup withholding as a result of a failure to report all interest or dividends, or (c) the IRS has notified me that I am no longer subject to backup withholding; and
3. I am a U.S. citizen or other U.S. person (defined below); and
4. The FATCA code(s) entered on this form (if any) indicating that I am exempt from FATCA reporting is correct.

Certification instructions. You must cross out item 2 above if you have been notified by the IRS that you are currently subject to backup withholding because you have failed to report all interest and dividends on your tax return. For real estate transactions, item 2 does not apply. For mortgage interest paid, acquisition or abandonment of secured property, cancellation of debt, contributions to an individual retirement arrangement (IRA), and generally, payments other than interest and dividends, you are not required to sign the certification, but you must provide your correct TIN. See the instructions for Part II, later.

Sign Here	Signature of U.S. person ▶	Date ▶
------------------	----------------------------	--------

General Instructions

Section references are to the Internal Revenue Code unless otherwise noted.

Future developments. For the latest information about developments related to Form W-9 and its instructions, such as legislation enacted after they were published, go to www.irs.gov/FormW9.

Purpose of Form

An individual or entity (Form W-9 requester) who is required to file an information return with the IRS must obtain your correct taxpayer identification number (TIN) which may be your social security number (SSN), individual taxpayer identification number (ITIN), adoption taxpayer identification number (ATIN), or employer identification number (EIN), to report on an information return the amount paid to you, or other amount reportable on an information return. Examples of information returns include, but are not limited to, the following.

- Form 1099-INT (interest earned or paid)

- Form 1099-DIV (dividends, including those from stocks or mutual funds)
- Form 1099-MISC (various types of income, prizes, awards, or gross proceeds)
- Form 1099-B (stock or mutual fund sales and certain other transactions by brokers)
- Form 1099-S (proceeds from real estate transactions)
- Form 1099-K (merchant card and third party network transactions)
- Form 1098 (home mortgage interest), 1098-E (student loan interest), 1098-T (tuition)
- Form 1099-C (canceled debt)
- Form 1099-A (acquisition or abandonment of secured property)

Use Form W-9 only if you are a U.S. person (including a resident alien), to provide your correct TIN.

If you do not return Form W-9 to the requester with a TIN, you might be subject to backup withholding. See What is backup withholding, later.

By signing the filled-out form, you:

1. Certify that the TIN you are giving is correct (or you are waiting for a number to be issued),
2. Certify that you are not subject to backup withholding, or
3. Claim exemption from backup withholding if you are a U.S. exempt payee. If applicable, you are also certifying that as a U.S. person, your allocable share of any partnership income from a U.S. trade or business is not subject to the withholding tax on foreign partners' share of effectively connected income, and
4. Certify that FATCA code(s) entered on this form (if any) indicating that you are exempt from the FATCA reporting, is correct. See *What is FATCA reporting*, later, for further information.

Note: If you are a U.S. person and a requester gives you a form other than Form W-9 to request your TIN, you must use the requester's form if it is substantially similar to this Form W-9.

Definition of a U.S. person. For federal tax purposes, you are considered a U.S. person if you are:

- An individual who is a U.S. citizen or U.S. resident alien;
- A partnership, corporation, company, or association created or organized in the United States or under the laws of the United States;
- An estate (other than a foreign estate); or
- A domestic trust (as defined in Regulations section 301.7701-7).

Special rules for partnerships. Partnerships that conduct a trade or business in the United States are generally required to pay a withholding tax under section 1446 on any foreign partners' share of effectively connected taxable income from such business. Further, in certain cases where a Form W-9 has not been received, the rules under section 1446 require a partnership to presume that a partner is a foreign person, and pay the section 1446 withholding tax. Therefore, if you are a U.S. person that is a partner in a partnership conducting a trade or business in the United States, provide Form W-9 to the partnership to establish your U.S. status and avoid section 1446 withholding on your share of partnership income.

In the cases below, the following person must give Form W-9 to the partnership for purposes of establishing its U.S. status and avoiding withholding on its allocable share of net income from the partnership conducting a trade or business in the United States.

- In the case of a disregarded entity with a U.S. owner, the U.S. owner of the disregarded entity and not the entity;
- In the case of a grantor trust with a U.S. grantor or other U.S. owner, generally, the U.S. grantor or other U.S. owner of the grantor trust and not the trust; and
- In the case of a U.S. trust (other than a grantor trust), the U.S. trust (other than a grantor trust) and not the beneficiaries of the trust.

Foreign person. If you are a foreign person or the U.S. branch of a foreign bank that has elected to be treated as a U.S. person, do not use Form W-9. Instead, use the appropriate Form W-8 or Form 8233 (see Pub. 515, *Withholding of Tax on Nonresident Aliens and Foreign Entities*).

Nonresident alien who becomes a resident alien. Generally, only a nonresident alien individual may use the terms of a tax treaty to reduce or eliminate U.S. tax on certain types of income. However, most tax treaties contain a provision known as a "saving clause." Exceptions specified in the saving clause may permit an exemption from tax to continue for certain types of income even after the payee has otherwise become a U.S. resident alien for tax purposes.

If you are a U.S. resident alien who is relying on an exception contained in the saving clause of a tax treaty to claim an exemption from U.S. tax on certain types of income, you must attach a statement to Form W-9 that specifies the following five items.

1. The treaty country. Generally, this must be the same treaty under which you claimed exemption from tax as a nonresident alien.
2. The treaty article addressing the income.
3. The article number (or location) in the tax treaty that contains the saving clause and its exceptions.
4. The type and amount of income that qualifies for the exemption from tax.
5. Sufficient facts to justify the exemption from tax under the terms of the treaty article.

Example. Article 20 of the U.S.-China income tax treaty allows an exemption from tax for scholarship income received by a Chinese student temporarily present in the United States. Under U.S. law, this student will become a resident alien for tax purposes if his or her stay in the United States exceeds 5 calendar years. However, paragraph 2 of the first Protocol to the U.S.-China treaty (dated April 30, 1984) allows the provisions of Article 20 to continue to apply even after the Chinese student becomes a resident alien of the United States. A Chinese student who qualifies for this exception (under paragraph 2 of the first protocol) and is relying on this exception to claim an exemption from tax on his or her scholarship or fellowship income would attach to Form W-9 a statement that includes the information described above to support that exemption.

If you are a nonresident alien or a foreign entity, give the requester the appropriate completed Form W-8 or Form 8233.

Backup Withholding

What is backup withholding? Persons making certain payments to you must under certain conditions withhold and pay to the IRS 24% of such payments. This is called "backup withholding." Payments that may be subject to backup withholding include interest, tax-exempt interest, dividends, broker and barter exchange transactions, rents, royalties, nonemployee pay, payments made in settlement of payment card and third party network transactions, and certain payments from fishing boat operators. Real estate transactions are not subject to backup withholding.

You will not be subject to backup withholding on payments you receive if you give the requester your correct TIN, make the proper certifications, and report all your taxable interest and dividends on your tax return.

Payments you receive will be subject to backup withholding if:

1. You do not furnish your TIN to the requester,
2. You do not certify your TIN when required (see the instructions for Part II for details),
3. The IRS tells the requester that you furnished an incorrect TIN,
4. The IRS tells you that you are subject to backup withholding because you did not report all your interest and dividends on your tax return (for reportable interest and dividends only), or
5. You do not certify to the requester that you are not subject to backup withholding under 4 above (for reportable interest and dividend accounts opened after 1983 only).

Certain payees and payments are exempt from backup withholding. See *Exempt payee code*, later, and the separate Instructions for the Requester of Form W-9 for more information.

Also see *Special rules for partnerships*, earlier.

What is FATCA Reporting?

The Foreign Account Tax Compliance Act (FATCA) requires a participating foreign financial institution to report all United States account holders that are specified United States persons. Certain payees are exempt from FATCA reporting. See *Exemption from FATCA reporting code*, later, and the Instructions for the Requester of Form W-9 for more information.

Updating Your Information

You must provide updated information to any person to whom you claimed to be an exempt payee if you are no longer an exempt payee and anticipate receiving reportable payments in the future from this person. For example, you may need to provide updated information if you are a C corporation that elects to be an S corporation, or if you no longer are tax exempt. In addition, you must furnish a new Form W-9 if the name or TIN changes for the account; for example, if the grantor of a grantor trust dies.

Penalties

Failure to furnish TIN. If you fail to furnish your correct TIN to a requester, you are subject to a penalty of \$50 for each such failure unless your failure is due to reasonable cause and not to willful neglect.

Civil penalty for false information with respect to withholding. If you make a false statement with no reasonable basis that results in no backup withholding, you are subject to a \$500 penalty.

Criminal penalty for falsifying information. Willfully falsifying certifications or affirmations may subject you to criminal penalties including fines and/or imprisonment.

Misuse of TINs. If the requester discloses or uses TINs in violation of federal law, the requester may be subject to civil and criminal penalties.

Specific Instructions

Line 1

You must enter one of the following on this line; **do not** leave this line blank. The name should match the name on your tax return.

If this Form W-9 is for a joint account (other than an account maintained by a foreign financial institution (FFI)), list first, and then circle, the name of the person or entity whose number you entered in Part I of Form W-9. If you are providing Form W-9 to an FFI to document a joint account, each holder of the account that is a U.S. person must provide a Form W-9.

a. **Individual.** Generally, enter the name shown on your tax return. If you have changed your last name without informing the Social Security Administration (SSA) of the name change, enter your first name, the last name as shown on your social security card, and your new last name.

Note: ITIN applicant: Enter your individual name as it was entered on your Form W-7 application, line 1a. This should also be the same as the name you entered on the Form 1040/1040A/1040EZ you filed with your application.

b. **Sole proprietor or single-member LLC.** Enter your individual name as shown on your 1040/1040A/1040EZ on line 1. You may enter your business, trade, or "doing business as" (DBA) name on line 2.

c. **Partnership, LLC that is not a single-member LLC, C corporation, or S corporation.** Enter the entity's name as shown on the entity's tax return on line 1 and any business, trade, or DBA name on line 2.

d. **Other entities.** Enter your name as shown on required U.S. federal tax documents on line 1. This name should match the name shown on the charter or other legal document creating the entity. You may enter any business, trade, or DBA name on line 2.

e. **Disregarded entity.** For U.S. federal tax purposes, an entity that is disregarded as an entity separate from its owner is treated as a "disregarded entity." See Regulations section 301.7701-2(c)(2)(iii). Enter the owner's name on line 1. The name of the entity entered on line 1 should never be a disregarded entity. The name on line 1 should be the name shown on the income tax return on which the income should be reported. For example, if a foreign LLC that is treated as a disregarded entity for U.S. federal tax purposes has a single owner that is a U.S. person, the U.S. owner's name is required to be provided on line 1. If the direct owner of the entity is also a disregarded entity, enter the first owner that is not disregarded for federal tax purposes. Enter the disregarded entity's name on line 2, "Business name/disregarded entity name." If the owner of the disregarded entity is a foreign person, the owner must complete an appropriate Form W-8 instead of a Form W-9. This is the case even if the foreign person has a U.S. TIN.

Line 2

If you have a business name, trade name, DBA name, or disregarded entity name, you may enter it on line 2.

Line 3

Check the appropriate box on line 3 for the U.S. federal tax classification of the person whose name is entered on line 1. Check only one box on line 3.

IF the entity/person on line 1 is a(n) . . .	THEN check the box for . . .
• Corporation	Corporation
• Individual • Sole proprietorship, or • Single-member limited liability company (LLC) owned by an individual and disregarded for U.S. federal tax purposes.	Individual/sole proprietor or single-member LLC
• LLC treated as a partnership for U.S. federal tax purposes, • LLC that has filed Form 8832 or 2553 to be taxed as a corporation, or • LLC that is disregarded as an entity separate from its owner but the owner is another LLC that is not disregarded for U.S. federal tax purposes.	Limited liability company and enter the appropriate tax classification. (P= Partnership; C= C corporation; or S= S corporation)
• Partnership	Partnership
• Trust/estate	Trust/estate

Line 4, Exemptions

If you are exempt from backup withholding and/or FATCA reporting, enter in the appropriate space on line 4 any code(s) that may apply to you.

Exempt payee code.

- Generally, individuals (including sole proprietors) are not exempt from backup withholding.
- Except as provided below, corporations are exempt from backup withholding for certain payments, including interest and dividends.
- Corporations are not exempt from backup withholding for payments made in settlement of payment card or third party network transactions.
- Corporations are not exempt from backup withholding with respect to attorneys' fees or gross proceeds paid to attorneys, and corporations that provide medical or health care services are not exempt with respect to payments reportable on Form 1099-MISC.

The following codes identify payees that are exempt from backup withholding. Enter the appropriate code in the space in line 4.

- 1—An organization exempt from tax under section 501(a), any IRA, or a custodial account under section 403(b)(7) if the account satisfies the requirements of section 401(f)(2)
- 2—The United States or any of its agencies or instrumentalities
- 3—A state, the District of Columbia, a U.S. commonwealth or possession, or any of their political subdivisions or instrumentalities
- 4—A foreign government or any of its political subdivisions, agencies, or instrumentalities
- 5—A corporation
- 6—A dealer in securities or commodities required to register in the United States, the District of Columbia, or a U.S. commonwealth or possession
- 7—A futures commission merchant registered with the Commodity Futures Trading Commission
- 8—A real estate investment trust
- 9—An entity registered at all times during the tax year under the Investment Company Act of 1940
- 10—A common trust fund operated by a bank under section 584(a)
- 11—A financial institution
- 12—A middleman known in the investment community as a nominee or custodian
- 13—A trust exempt from tax under section 664 or described in section 4947

The following chart shows types of payments that may be exempt from backup withholding. The chart applies to the exempt payees listed above, 1 through 13.

IF the payment is for . . .	THEN the payment is exempt for . . .
Interest and dividend payments	All exempt payees except for 7
Broker transactions	Exempt payees 1 through 4 and 6 through 11 and all C corporations. S corporations must not enter an exempt payee code because they are exempt only for sales of noncovered securities acquired prior to 2012.
Barter exchange transactions and patronage dividends	Exempt payees 1 through 4
Payments over \$600 required to be reported and direct sales over \$5,000 ¹	Generally, exempt payees 1 through 5 ²
Payments made in settlement of payment card or third party network transactions	Exempt payees 1 through 4

¹ See Form 1099-MISC, Miscellaneous Income, and its instructions.

² However, the following payments made to a corporation and reportable on Form 1099-MISC are not exempt from backup withholding: medical and health care payments, attorneys' fees, gross proceeds paid to an attorney reportable under section 6045(f), and payments for services paid by a federal executive agency.

Exemption from FATCA reporting code. The following codes identify payees that are exempt from reporting under FATCA. These codes apply to persons submitting this form for accounts maintained outside of the United States by certain foreign financial institutions. Therefore, if you are only submitting this form for an account you hold in the United States, you may leave this field blank. Consult with the person requesting this form if you are uncertain if the financial institution is subject to these requirements. A requester may indicate that a code is not required by providing you with a Form W-9 with "Not Applicable" (or any similar indication) written or printed on the line for a FATCA exemption code.

A—An organization exempt from tax under section 501(a) or any individual retirement plan as defined in section 7701(a)(37)

B—The United States or any of its agencies or instrumentalities

C—A state, the District of Columbia, a U.S. commonwealth or possession, or any of their political subdivisions or instrumentalities

D—A corporation the stock of which is regularly traded on one or more established securities markets, as described in Regulations section 1.1472-1(c)(1)(i)

E—A corporation that is a member of the same expanded affiliated group as a corporation described in Regulations section 1.1472-1(c)(1)(ii)

F—A dealer in securities, commodities, or derivative financial instruments (including notional principal contracts, futures, forwards, and options) that is registered as such under the laws of the United States or any state

G—A real estate investment trust

H—A regulated investment company as defined in section 851 or an entity registered at all times during the tax year under the Investment Company Act of 1940

I—A common trust fund as defined in section 584(a)

J—A bank as defined in section 581

K—A broker

L—A trust exempt from tax under section 664 or described in section 4947(a)(1)

M—A tax exempt trust under a section 403(b) plan or section 457(g) plan

Note: You may wish to consult with the financial institution requesting this form to determine whether the FATCA code and/or exempt payee code should be completed.

Line 5

Enter your address (number, street, and apartment or suite number). This is where the requester of this Form W-9 will mail your information returns. If this address differs from the one the requester already has on file, write NEW at the top. If a new address is provided, there is still a chance the old address will be used until the payor changes your address in their records.

Line 6

Enter your city, state, and ZIP code.

Part I. Taxpayer Identification Number (TIN)

Enter your TIN in the appropriate box. If you are a resident alien and you do not have and are not eligible to get an SSN, your TIN is your IRS individual taxpayer identification number (ITIN). Enter it in the social security number box. If you do not have an ITIN, see *How to get a TIN* below.

If you are a sole proprietor and you have an EIN, you may enter either your SSN or EIN.

If you are a single-member LLC that is disregarded as an entity separate from its owner, enter the owner's SSN (or EIN, if the owner has one). Do not enter the disregarded entity's EIN. If the LLC is classified as a corporation or partnership, enter the entity's EIN.

Note: See *What Name and Number To Give the Requester*, later, for further clarification of name and TIN combinations.

How to get a TIN. If you do not have a TIN, apply for one immediately. To apply for an SSN, get Form SS-5, Application for a Social Security Card, from your local SSA office or get this form online at www.SSA.gov. You may also get this form by calling 1-800-772-1213. Use Form W-7, Application for IRS Individual Taxpayer Identification Number, to apply for an ITIN, or Form SS-4, Application for Employer Identification Number, to apply for an EIN. You can apply for an EIN online by accessing the IRS website at www.irs.gov/Businesses and clicking on Employer Identification Number (EIN) under Starting a Business. Go to www.irs.gov/Forms to view, download, or print Form W-7 and/or Form SS-4. Or, you can go to www.irs.gov/OrderForms to place an order and have Form W-7 and/or SS-4 mailed to you within 10 business days.

If you are asked to complete Form W-9 but do not have a TIN, apply for a TIN and write "Applied For" in the space for the TIN, sign and date the form, and give it to the requester. For interest and dividend payments, and certain payments made with respect to readily tradable instruments, generally you will have 60 days to get a TIN and give it to the requester before you are subject to backup withholding on payments. The 60-day rule does not apply to other types of payments. You will be subject to backup withholding on all such payments until you provide your TIN to the requester.

Note: Entering "Applied For" means that you have already applied for a TIN or that you intend to apply for one soon.

Caution: A disregarded U.S. entity that has a foreign owner must use the appropriate Form W-8.

Part II. Certification

To establish to the withholding agent that you are a U.S. person, or resident alien, sign Form W-9. You may be requested to sign by the withholding agent even if item 1, 4, or 5 below indicates otherwise.

For a joint account, only the person whose TIN is shown in Part I should sign (when required). In the case of a disregarded entity, the person identified on line 1 must sign. Exempt payees, see *Exempt payee code*, earlier.

Signature requirements. Complete the certification as indicated in items 1 through 5 below.

1. Interest, dividend, and barter exchange accounts opened before 1984 and broker accounts considered active during 1983. You must give your correct TIN, but you do not have to sign the certification.

2. Interest, dividend, broker, and barter exchange accounts opened after 1983 and broker accounts considered inactive during 1983. You must sign the certification or backup withholding will apply. If you are subject to backup withholding and you are merely providing your correct TIN to the requester, you must cross out item 2 in the certification before signing the form.

3. Real estate transactions. You must sign the certification. You may cross out item 2 of the certification.

4. Other payments. You must give your correct TIN, but you do not have to sign the certification unless you have been notified that you have previously given an incorrect TIN. "Other payments" include payments made in the course of the requester's trade or business for rents, royalties, goods (other than bills for merchandise), medical and health care services (including payments to corporations), payments to a nonemployee for services, payments made in settlement of payment card and third party network transactions, payments to certain fishing boat crew members and fishermen, and gross proceeds paid to attorneys (including payments to corporations).

5. Mortgage interest paid by you, acquisition or abandonment of secured property, cancellation of debt, qualified tuition program payments (under section 529), ABLÉ accounts (under section 529A), IRA, Coverdell ESA, Archer MSA or HSA contributions or distributions, and pension distributions. You must give your correct TIN, but you do not have to sign the certification.

What Name and Number To Give the Requester

For this type of account:	Give name and SSN of:
1. Individual	The individual
2. Two or more individuals (joint account) other than an account maintained by an FFI	The actual owner of the account or, if combined funds, the first individual on the account ¹
3. Two or more U.S. persons (joint account maintained by an FFI)	Each holder of the account
4. Custodial account of a minor (Uniform Gift to Minors Act)	The minor ²
5. a. The usual revocable savings trust (grantor is also trustee) b. So-called trust account that is not a legal or valid trust under state law	The grantor-trustee ¹ The actual owner ¹
6. Sole proprietorship or disregarded entity owned by an individual	The owner ³
7. Grantor trust filing under Optional Form 1099 Filing Method 1 (see Regulations section 1.671-4(b)(2)(i)(A))	The grantor ⁴
For this type of account:	Give name and EIN of:
8. Disregarded entity not owned by an individual	The owner
9. A valid trust, estate, or pension trust	Legal entity ⁴
10. Corporation or LLC electing corporate status on Form 8832 or Form 2553	The corporation
11. Association, club, religious, charitable, educational, or other tax-exempt organization	The organization
12. Partnership or multi-member LLC	The partnership
13. A broker or registered nominee	The broker or nominee

For this type of account:	Give name and EIN of:
14. Account with the Department of Agriculture in the name of a public entity (such as a state or local government, school district, or prison) that receives agricultural program payments	The public entity
15. Grantor trust filing under the Form 1041 Filing Method or the Optional Form 1099 Filing Method 2 (see Regulations section 1.671-4(b)(2)(i)(B))	The trust

¹ List first and circle the name of the person whose number you furnish. If only one person on a joint account has an SSN, that person's number must be furnished.

² Circle the minor's name and furnish the minor's SSN.

³ You must show your individual name and you may also enter your business or DBA name on the "Business name/disregarded entity" name line. You may use either your SSN or EIN (if you have one), but the IRS encourages you to use your SSN.

⁴ List first and circle the name of the trust, estate, or pension trust. (Do not furnish the TIN of the personal representative or trustee unless the legal entity itself is not designated in the account title.) Also see *Special rules for partnerships*, earlier.

***Note:** The grantor also must provide a Form W-9 to trustee of trust.

Note: If no name is circled when more than one name is listed, the number will be considered to be that of the first name listed.

Secure Your Tax Records From Identity Theft

Identity theft occurs when someone uses your personal information such as your name, SSN, or other identifying information, without your permission, to commit fraud or other crimes. An identity thief may use your SSN to get a job or may file a tax return using your SSN to receive a refund.

To reduce your risk:

- Protect your SSN,
 - Ensure your employer is protecting your SSN, and
 - Be careful when choosing a tax preparer.
- If your tax records are affected by identity theft and you receive a notice from the IRS, respond right away to the name and phone number printed on the IRS notice or letter.

If your tax records are not currently affected by identity theft but you think you are at risk due to a lost or stolen purse or wallet, questionable credit card activity or credit report, contact the IRS Identity Theft Hotline at 1-800-908-4490 or submit Form 14039.

For more information, see Pub. 5027, Identity Theft Information for Taxpayers.

Victims of identity theft who are experiencing economic harm or a systemic problem, or are seeking help in resolving tax problems that have not been resolved through normal channels, may be eligible for Taxpayer Advocate Service (TAS) assistance. You can reach TAS by calling the TAS toll-free case intake line at 1-877-777-4778 or TTY/TDD 1-800-829-4059.

Protect yourself from suspicious emails or phishing schemes. Phishing is the creation and use of email and websites designed to mimic legitimate business emails and websites. The most common act is sending an email to a user falsely claiming to be an established legitimate enterprise in an attempt to scam the user into surrendering private information that will be used for identity theft.

The IRS does not initiate contacts with taxpayers via emails. Also, the IRS does not request personal detailed information through email or ask taxpayers for the PIN numbers, passwords, or similar secret access information for their credit card, bank, or other financial accounts.

If you receive an unsolicited email claiming to be from the IRS, forward this message to phishing@irs.gov. You may also report misuse of the IRS name, logo, or other IRS property to the Treasury Inspector General for Tax Administration (TIGTA) at 1-800-366-4484. You can forward suspicious emails to the Federal Trade Commission at spam@uce.gov or report them at www.ftc.gov/complaint. You can contact the FTC at www.ftc.gov/idtheft or 877-IDTHEFT (877-438-4338). If you have been the victim of identity theft, see www.IdentityTheft.gov and Pub. 5027.

Visit www.irs.gov/IdentityTheft to learn more about identity theft and how to reduce your risk.

Privacy Act Notice

Section 6109 of the Internal Revenue Code requires you to provide your correct TIN to persons (including federal agencies) who are required to file information returns with the IRS to report interest, dividends, or certain other income paid to you; mortgage interest you paid; the acquisition or abandonment of secured property; the cancellation of debt; or contributions you made to an IRA, Archer MSA, or HSA. The person collecting this form uses the information on the form to file information returns with the IRS, reporting the above information. Routine uses of this information include giving it to the Department of Justice for civil and criminal litigation and to cities, states, the District of Columbia, and U.S. commonwealths and possessions for use in administering their laws. The information also may be disclosed to other countries under a treaty, to federal and state agencies to enforce civil and criminal laws, or to federal law enforcement and intelligence agencies to combat terrorism. You must provide your TIN whether or not you are required to file a tax return. Under section 3406, payers must generally withhold a percentage of taxable interest, dividend, and certain other payments to a payee who does not give a TIN to the payer. Certain penalties may also apply for providing false or fraudulent information.

Attachment M

Sample Bid Bond

Form



SAMPLE FORM OF BID BOND

BID BOND

KNOW ALL MEN BY THESE PRESENTS:

That we, _____ as Principal, hereinafter called the Principal, and _____ a corporation duly organized under the laws of the State of Louisiana, as Surety, are held and firmly bound unto the Housing Authority of New Orleans (HANO), for the sum of _____ Dollars (\$ _____), for the payment of which sum well and truly to be made, the said Principal and the said Surety bind ourselves, our heirs, executors, administrators, successors, and assigns, jointly and severally, firmly be these presents.

WHEREAS, the Principal has submitted a bid for _____

_____ Located at _____
(Identify project by number and brief description)

NOW THEREFORE, if the HANO shall accept the bid of the Principal and the Principal shall enter into a contract with the HANO in accordance with the terms of such bid, and give such bond or bonds as may be specified in the bidding or Contract Documents with good and sufficient surety for the faithful performance of such contract and for the prompt payment of labor and material furnished in the prosecution thereof, or in the event of the failure of the Principal to enter such Contract and give such bond or bonds, if the Principal shall pay to the HANO the difference not to exceed the penalty hereof between the amount specified in said bid and such larger amount for which the HANO may in good faith contract with another party to perform work covered by said bid or an appropriate required amount as specified in the Invitation for Bids, the foregoing to include any other purposes or items set out in, and to be subject to, provisions of La. R.S. 38:2241; 38:2216, as amended, then this obligation shall be null and void; otherwise to remain in full force and effect.

IN WITNESS WHEREOF, the Principal and Surety have hereto set their hands and seals, this __ day of _____, 20_____.

PRINCIPAL

SURETY

(Name and Seal)

(Attorney-in-Fact)

ATTEST: _____

ATTEST: _____

Attachment N

Performance Bond

Sample Form

(only required post-bid from
awarded bidder)



INVITATION FOR BIDS (IFB) No. 23-912-41 Water Softener System for Guste High Rise

PERFORMANCE AND PAYMENT BOND (OR BONDS)

CITY OF: _____ STATE OF: LOUISIANA

PARISH OF: _____ PROJECT NO: _____

KNOW ALL MEN BY THESE PRESENTS: That we, the undersigned: _____

Of the City of _____ Parish of _____, State of _____

As Principal, and _____, duly authorized under the Laws of the State of Louisiana to act as surety on bonds for the Principals, and as SURETY, are held and firmly bound unto the HOUSING AUTHORITY of the City of NEW ORLEANS, in Louisiana, a public body corporate and politic, created under and by virtue of the Laws of the State of Louisiana, (hereinafter referred to as the Local Authority) and to subcontractors, workmen, laborers, mechanics, furnishers of materials, and to all others entitled to protection under public Contract Bonds in accordance with the Laws of this State, the provisions of such Laws being incorporated herein by reference as their interest may appear, all of whom shall have the right to sue upon this Bond in the penal sum of:

_____ (\$_____)

THE CONDITION OF THIS OBLIGATION IS SUCH THAT, WHEREAS,

The above bounded Principal has on the _____ day of _____, 20____, by an Instrument in writing, entered into a Contract with the Local Authority to furnish all materials, labor, tools, equipment, supervision, and other accessories, and to do all work necessary to complete the requirements within the Plans and Specifications for: _____, and Addenda thereto, numbered _____ Dated: _____ and, which said Specifications, Addenda and Drawings are incorporated herein by reference, and made a part hereof.

NOW, THEREFORE, if the said principal shall well and truly in good sufficient and workmanlike manner, faithfully perform said Contract and Agreement, and shall and will in all respects duly and faithfully perform all and singular the covenant-conditions and agreements in and by said Contract agreed and covenanted by the said Principal, to be observed and performed and according to the true intent and meaning of said Contract, Plans and Specifications thereunder perform and complete the work required, and shall defend, indemnify and save harmless said Local Authority against all damages, claims, demands, expenses, and charges of every kind (including claims of patent infringement) arising out of injury or damage to persons or property by reason of said Contract and the work thereunder required of said Principal or arising from any act, omission or neglect of said Principal, his agents, or employees with relation to said work and shall pay all costs, charges, rentals, and

HOUSING AUTHORITY OF NEW ORLEANS, LA

INVITATION FOR BIDS (IFB) No. 23-912-41 Water Softener System for Guste High Rise

expenses for labor, materials, supplies, and equipment, and deliver to the said Local Authority completed and ready for occupancy or operation and free from all liens, encumbrances, or claims for labor, materials or otherwise, during the original term of same, as well as during any period of extension of said Contract that may be granted on the part of the Local Authority; and shall promptly well and truly make payment to persons, firms, corporations, subcontractors, workmen, laborers, mechanics, furnishing materials for, or performing labor in prosecution of work provided in such Contract, all moneys to them owing by said Principal for subcontractor's work, labor and materials, workmen's compensation insurance, excise taxes or other lawful public charges, provided, furnished, or applicable to the construction of such improvements, provided in such Contract, for the said Local Authority and shall pay to the said Local Authority, all penalties provided for under the laws of this State for the violation of any provisions of law and/or of the provisions of said Contract, and shall pay all other expenses lawfully chargeable to the said Local Authority by reason of any default or neglect in the relation of said Contract and said work-then the obligation shall be and become null and void, otherwise to remain in full force and effect.

No modifications, omissions, or additions in or to the terms of said Contract, in the Plans and Specifications, or in the manner and mode of payment, shall in any manner affect the obligation of the undersigned Surety in connection with the aforesaid Contract.

The undersigned hereby does further consent and yield to the jurisdiction of the Civil District Court for the Parish of Orleans, in the State of Louisiana and does hereby formally waive any pleas of jurisdiction on account of the residence elsewhere of the undersigned Surety, as well as all pleas or discussions in regard to the Contractor, its Principal under this Bond.

IN WITNESS WHEREOF, the above bonded parties have executed this Instrument under their several Seals, and these presents duly signed by their undersigned representative pursuant to the authority of their governing bodies;

IN THE PRESENCE OF:

ATTEST:

By: _____

Title: _____

Date: _____

INVITATION FOR BIDS (IFB) No. 23-912-41 Water Softener System for Guste High Rise

BUSINESS ADDRESS:

(Corporate Surety)

ATTEST:

By: _____

Title: Attorney-in-Fact

Date: _____

BUSINESS ADDRESS:

The rate of premium on this bond is \$ _____ per thousand

The total amount of premium is \$ _____

Attachment O
Davis Bacon
Wage Rates



"General Decision Number: LA20230041 06/16/2023

Superseded General Decision Number: LA20220041

State: Louisiana

Construction Type: Building

County: Orleans County in Louisiana.

BUILDING CONSTRUCTION PROJECTS (does not include single family homes or apartments up to and including 4 stories).

Note: Contracts subject to the Davis-Bacon Act are generally required to pay at least the applicable minimum wage rate required under Executive Order 14026 or Executive Order 13658. Please note that these Executive Orders apply to covered contracts entered into by the federal government that are subject to the Davis-Bacon Act itself, but do not apply to contracts subject only to the Davis-Bacon Related Acts, including those set forth at 29 CFR 5.1(a)(2)-(60).

If the contract is entered into on or after January 30, 2022, or the contract is renewed or extended (e.g., an option is exercised) on or after January 30, 2022:	. Executive Order 14026 generally applies to the contract. . The contractor must pay all covered workers at least \$16.20 per hour (or the applicable wage rate listed on this wage determination, if it is higher) for all hours spent performing on the contract in 2023.
If the contract was awarded on or between January 1, 2015 and January 29, 2022, and the contract is not renewed or extended on or after January 30, 2022:	. Executive Order 13658 generally applies to the contract. . The contractor must pay all covered workers at least \$12.15 per hour (or the applicable wage rate listed on this wage determination, if it is higher) for all hours spent performing on that contract in 2023.

The applicable Executive Order minimum wage rate will be adjusted annually. If this contract is covered by one of the Executive Orders and a classification considered necessary for performance of work on the contract does not appear on this wage determination, the contractor must still submit a conformance request.

Additional information on contractor requirements and worker protections under the Executive Orders is available at <http://www.dol.gov/whd/govcontracts>.

Modification Number	Publication Date
0	01/06/2023
1	01/13/2023

2 01/20/2023
3 06/16/2023

ASBE0053-001 08/29/2022

	Rates	Fringes
ASBESTOS WORKER/HEAT & FROST INSULATOR.....	\$ 30.20	9.62

ELEC0130-010 12/05/2022

	Rates	Fringes
ELECTRICIAN (Including Communication Technician and Low Voltage Wiring).....	\$ 32.75	14.51

ELEV0016-001 01/01/2023

	Rates	Fringes
ELEVATOR MECHANIC.....	\$ 46.83	37.335+a+b

a. PAID HOLIDAYS: New Year's Day, Memorial Day, Independence Day, Labor Day, Veterans' Day, Thanksgiving Day, the Friday after Thanksgiving Day and Christmas Day.

b. VACATION: Employer contributes 8% of basic hourly rate for 5 years or more of service; 6% of basic hourly rate for under 5 years of service as vacation pay credit.

ENGI0406-002 07/01/2014

	Rates	Fringes
POWER EQUIPMENT OPERATOR (Crane).....	\$ 23.46	8.35

CRANE PREMIUMS:
50-150 Tons \$1.75
Over 150 Tons \$2.25

IRON0623-021 01/01/2023

	Rates	Fringes
IRONWORKER (REINFORCING AND STRUCTURAL).....	\$ 33.25	12.22

PAIN1244-006 09/01/2022

	Rates	Fringes
GLAZIER.....	\$ 23.41	11.65

PAIN1244-013 12/01/2021

	Rates	Fringes
PAINTER: Spray Only (Excludes Drywall Finishing/Taping).....	\$ 18.83	9.48

	Rates	Fringes
CEMENT MASON/CONCRETE FINISHER...	\$ 30.47	7.97

* PLUM0060-009 06/05/2023

	Rates	Fringes
PIPEFITTER (Including HVAC Pipe and Unit Installation; Excluding Installation of HVAC Temperature Controls).....	\$ 31.70	13.85
PLUMBER (Installation of HVAC Temperature Controls; Excluding HVAC Pipe and Unit Installation).....	\$ 31.70	13.85

SHEE0214-010 09/01/2013

	Rates	Fringes
SHEET METAL WORKER (Including HVAC Duct Installation).....	\$ 26.71	11.93

* SULA2012-026 09/22/2014

	Rates	Fringes
BRICKLAYER.....	\$ 18.66	0.00
CARPENTER (Form Work Only).....	\$ 15.00 **	0.00
CARPENTER, Excludes Drywall Hanging and Metal Stud Installation, and Form Work.....	\$ 19.37	2.46
DRYWALL FINISHER/TAPER.....	\$ 16.55	0.00
DRYWALL HANGER AND METAL STUD INSTALLER.....	\$ 18.21	4.90
LABORER: Common or General.....	\$ 13.09 **	0.00
LABORER: Mason Tender - Brick...	\$ 12.38 **	0.00
OPERATOR: Backhoe/Excavator/Trackhoe.....	\$ 22.92	0.00
PAINTER (BRUSH AND ROLLER), Excludes Drywall Finishing/Taping.....	\$ 17.25	0.00
ROOFER.....	\$ 16.77	5.66
SPRINKLER FITTER (Fire Sprinklers).....	\$ 21.08	5.79
TILE SETTER.....	\$ 20.00	0.00
TRUCK DRIVER: Dump Truck.....	\$ 15.00 **	0.00

WELDERS - Receive rate prescribed for craft performing

operation to which welding is incidental.

** Workers in this classification may be entitled to a higher minimum wage under Executive Order 14026 (\$16.20) or 13658 (\$12.15). Please see the Note at the top of the wage determination for more information.

Note: Executive Order (EO) 13706, Establishing Paid Sick Leave for Federal Contractors applies to all contracts subject to the Davis-Bacon Act for which the contract is awarded (and any solicitation was issued) on or after January 1, 2017. If this contract is covered by the EO, the contractor must provide employees with 1 hour of paid sick leave for every 30 hours they work, up to 56 hours of paid sick leave each year. Employees must be permitted to use paid sick leave for their own illness, injury or other health-related needs, including preventive care; to assist a family member (or person who is like family to the employee) who is ill, injured, or has other health-related needs, including preventive care; or for reasons resulting from, or to assist a family member (or person who is like family to the employee) who is a victim of, domestic violence, sexual assault, or stalking. Additional information on contractor requirements and worker protections under the EO is available at <https://www.dol.gov/agencies/whd/government-contracts>.

Unlisted classifications needed for work not included within the scope of the classifications listed may be added after award only as provided in the labor standards contract clauses (29CFR 5.5 (a) (1) (ii)).

The body of each wage determination lists the classification and wage rates that have been found to be prevailing for the cited type(s) of construction in the area covered by the wage determination. The classifications are listed in alphabetical order of ""identifiers"" that indicate whether the particular rate is a union rate (current union negotiated rate for local), a survey rate (weighted average rate) or a union average rate (weighted union average rate).

Union Rate Identifiers

A four letter classification abbreviation identifier enclosed in dotted lines beginning with characters other than ""SU"" or ""UAVG"" denotes that the union classification and rate were prevailing for that classification in the survey. Example: PLUM0198-005 07/01/2014. PLUM is an abbreviation identifier of the union which prevailed in the survey for this classification, which in this example would be Plumbers. 0198 indicates the local union number or district council number where applicable, i.e., Plumbers Local 0198. The next number, 005 in the example, is an internal number used in processing the wage determination. 07/01/2014 is the effective date of the most current negotiated rate, which in this example is July 1, 2014.

Union prevailing wage rates are updated to reflect all rate changes in the collective bargaining agreement (CBA) governing this classification and rate.

Survey Rate Identifiers

Classifications listed under the "SU" identifier indicate that no one rate prevailed for this classification in the survey and the published rate is derived by computing a weighted average rate based on all the rates reported in the survey for that classification. As this weighted average rate includes all rates reported in the survey, it may include both union and non-union rates. Example: SULA2012-007 5/13/2014. SU indicates the rates are survey rates based on a weighted average calculation of rates and are not majority rates. LA indicates the State of Louisiana. 2012 is the year of survey on which these classifications and rates are based. The next number, 007 in the example, is an internal number used in producing the wage determination. 5/13/2014 indicates the survey completion date for the classifications and rates under that identifier.

Survey wage rates are not updated and remain in effect until a new survey is conducted.

Union Average Rate Identifiers

Classification(s) listed under the UAVG identifier indicate that no single majority rate prevailed for those classifications; however, 100% of the data reported for the classifications was union data. EXAMPLE: UAVG-OH-0010 08/29/2014. UAVG indicates that the rate is a weighted union average rate. OH indicates the state. The next number, 0010 in the example, is an internal number used in producing the wage determination. 08/29/2014 indicates the survey completion date for the classifications and rates under that identifier.

A UAVG rate will be updated once a year, usually in January of each year, to reflect a weighted average of the current negotiated/CBA rate of the union locals from which the rate is based.

WAGE DETERMINATION APPEALS PROCESS

1.) Has there been an initial decision in the matter? This can be:

- * an existing published wage determination
- * a survey underlying a wage determination
- * a Wage and Hour Division letter setting forth a position on a wage determination matter
- * a conformance (additional classification and rate) ruling

On survey related matters, initial contact, including requests for summaries of surveys, should be with the Wage and Hour National Office because National Office has responsibility for the Davis-Bacon survey program. If the response from this initial contact is not satisfactory, then the process described in 2.) and 3.) should be followed.

With regard to any other matter not yet ripe for the formal process described here, initial contact should be with the Branch of Construction Wage Determinations. Write to:

Branch of Construction Wage Determinations

Wage and Hour Division
U.S. Department of Labor
200 Constitution Avenue, N.W.
Washington, DC 20210

2.) If the answer to the question in 1.) is yes, then an interested party (those affected by the action) can request review and reconsideration from the Wage and Hour Administrator (See 29 CFR Part 1.8 and 29 CFR Part 7). Write to:

Wage and Hour Administrator
U.S. Department of Labor
200 Constitution Avenue, N.W.
Washington, DC 20210

The request should be accompanied by a full statement of the interested party's position and by any information (wage payment data, project description, area practice material, etc.) that the requestor considers relevant to the issue.

3.) If the decision of the Administrator is not favorable, an interested party may appeal directly to the Administrative Review Board (formerly the Wage Appeals Board). Write to:

Administrative Review Board
U.S. Department of Labor
200 Constitution Avenue, N.W.
Washington, DC 20210

4.) All decisions by the Administrative Review Board are final.

=====

END OF GENERAL DECISION"

Attachment P

Employment, Training, and Contracting Policy



Housing Authority of New Orleans



Housing Authority of New Orleans

EMPLOYMENT, TRAINING, AND CONTRACTING POLICY

Table of Contents

Page

Part I- Policy, Purpose, Requirements, Definitions

A. Introduction and Summary.....	3
B. Definitions.....	4
C. HANO Section 3 & DBE/WBE Policy Statements	7
D. Section 3 New Hire and Contracting Requirements.....	8
E. DBE/WBE Contract Requirements.....	10

Part II- Procurement & Contractor Requirements and Procedures

A. Section 3 Contracting Procedures	11
B. DBE/WBE Contracting Procedures	13
C. Reporting Open Positions.....	14

Part III – Compliance Requirements

A. Compliance Requirements for Hiring & Contracting	15
B. Project Labor Agreements or Community Workforce Agreements.....	15

Part IV – Training Requirements

A. Training and Internship Requirements.....	16
--	----

Part V – Contracting and Compliance Forms

A. Section -3 Individual Verification Form.....	18
B. Section -3 Employment Action Plan.....	21
C. Section -3 Training Action Plan.....	22
D. Contracting and Action Plan for Section 3/DBE/WBE.....	23
E. List of Core Employees.....	24
F. Contracting Schedule.....	25
G. Section -3 Employment and Training Schedule.....	26
H. Letter of Intent.....	27
I. Statement of Understanding.....	28
J. Contractors Section -3 Employment and Training Compliance Report.....	29
K. Employer Paid Training Report.....	30
L. Section -3 Labor/Manhour Report.....	31
M. Contracting Compliance Report.....	33
N. Employment Assessment.....	34

Part I: Policy, Purpose, Requirements, Definitions

A. Introduction and Summary

The Housing Authority of New Orleans (HANO) has established a policy whereby any contractor that transacts business with HANO must meet the requirements of HANO's Section 3 and DBE/WBE policy as outlined in this document. This policy applies to all contracts valued at \$100,000 or greater. Contractors will: 1) offer Section 3 employment, training and employment skill building programs for eligible Section 3 residents and 2) provide Section 3 Business Concerns, Disadvantaged Business Enterprises (DBEs) as well as Woman Business Enterprises (WBEs) with the maximum opportunity to participate in the performance of contracts awarded by HANO. HANO will make a good faith effort to recruit as many Section 3 eligible residents and businesses as possible for employment and instructional positions and contract opportunities, in an effort to provide economic opportunities for area residents and area business concerns.

This document serves to fulfill two (2) main objectives: 1) it outlines the Section 3 & Section 3 Business Concerns/DBE/WBE policy and program compliance measures of HANO, and 2) it contains program definitions, requirements, required forms, information on program assistance provided by HANO, and other information related to HANO's Employment, Training and Contracting Policy. This document replaces all previous policies and is in immediate effect as of the HANO Board approval date.

Summary of Requirements

	Targeted Section 3 Worker	Section 3 Worker	SMDBE Contracting	WBE Contracting	Section 3 Contracting	Section 3 Training & Internship
Requirements	A worker employed by a Section 3 business concern or a worker who currently fits or when hired fits at least one of the following categories, as documented within the past 5 years. 1. Public Housing resident, Section 8 assisted housing or Youthbuild. 2. Income-eligible resident of Public Housing or Section 8 assisted housing managed by the PHA. 3. Youthbuild Participant. 4. Labor Benchmark of 5%. **Included in the 25% requirement.	Individual's income is below the Low-Income limit is less than 80% AML. Employed by a Low-Income business concern. Youthbuild Participant. Labor Benchmark of 25%.	25% of the value of the construction contracts.	5% of the value of the construction contracts.	10% of the value of the construction contracts.	Paid Training and Internship Spots as listed in the Chart on Page 16 of HANO's Employment, Training and Contracting Policy.

These requirements apply to all prime and subcontractors where the value of the contract with HANO is \$100,000 or greater.

B. Definitions

Labor Hours: The number of paid hours worked by persons on a Section 3 project or by persons employed with funds that include public housing assistance.

Professional Services: Non-construction services that require an advanced degree or professional licensing, including, but not limited to, contract for legal services, financial consulting, accounting services, environmental services, architectural services, and civil engineering services.

Local Hire: Employee Residing within Orleans Parish.

Low-Income Person: A family (including single persons) whose income does not exceed 80% of the median income for the area, as determined by HUD, with adjustments for smaller and larger families.

Very Low-Income Person: A family (including single persons) whose income does not exceed 50% of the median family income for the area, as determined by HUD, with adjustments for smaller and larger families.

New Hires: Full-time employees not previously employed on this contract for permanent, temporary or seasonal employment opportunities.

Section 3 Worker: Any worker who currently fits or, when hired within the past 5 year fit, at least one of the following categories, as documented:

- (1) The worker's income for the previous or annualized calendar year is below the income limit established by HUD, or
- (2) The worker is employed by a Section 3 Business Concern, or
- (3) The worker is a YouthBuild participant.

Service area or the neighborhood of the project: An area within one mile of the Section 3 project or, if fewer than 5,000 people live within one mile of a Section 3 project, within a circle centered on the Section 3 project that is sufficient to encompass a population of 5,000 people according to the most recent U.S. Census.

Core Employees: Persons listed and verified as employed with company before the contract execution date.

Contractor: Any entity which contracts for the performance of work generated by the expenditure of Section 3 covered assistance, or performing work in connection with a Section 3 covered project.

Housing Authority (HA): Public Housing Agency

Housing Development: Housing owned, developed, or operated by public housing agencies in accordance with HUD's public housing program regulations codified in 24 CFR Chapter IX.

Employment Opportunities Generated by Section 3 Covered Assistance: All employment opportunities generated by the expenditure of Section 3 covered public assistance (i.e., operating assistance, development assistance and modernization assistance, (as described in 24 CFR Section 135.3 (a) (1)). With respect to Section 3 covered housing and community development assistance, this term means all employment opportunities arising in connection with Section 3 covered projects (as described in Section 135.3 (a) (2)), including management and administrative jobs. Management and administrative jobs include architectural, engineering or related professional services required to prepare plans, drawings, specifications, or work write-ups; and jobs directly related to administrative support of these activities, e.g., construction manager, relocation specialist, payroll clerk, etc.

HUD Youthbuild Programs: Programs that receive assistance under subtitle D of Title IV of the National Affordable Housing Act, as amended by the Housing and Community Development Act of 1992 (42 U.S.C. 12899), and provide disadvantaged youth with opportunities for employment, education, leadership development, and training in the construction or rehabilitation of housing for homeless individuals and members of low- and very low-income families.

Recipient: Any entity which receives Section 3 covered assistance, directly from HUD or from another recipient and includes, but is not limited to, any State unit of local government, PHA, or other public body, public or private nonprofit organization, private agency or institution, mortgagor, developer, limited dividend sponsor, builder, property manager, community housing development organization, resident management corporation, resident council, or cooperative association. Recipient also includes any successor, assignee or transferee of any such entity, but does not include any ultimate beneficiary under the HUD program to which Section 3 applies and does not include contractors.

Section 3: Section 3 of the Housing and Urban Development Act of 1968, as amended (12 U.S.C. 1701u).

Section 3 Business Concern:

- (1) Business concerns that 51 percent (51%) owned and controlled by current public housing residents or residents who currently live in Section 8-assisted housing; or
- (2) Business where over 75 percent (75%) of the labor hours performed for the business over the prior three-month period are performed by Section 3 workers; or
- (3) Business concerns that are at least 51 percent (51%) owned and controlled by low- or very low-income persons.

Section 3 Covered Contracts: A contract or subcontract (including a professional service contract) awarded by a recipient or contractor for work generated by the expenditure of Section 3 covered assistance, or for work arising in connection with a Section 3 covered project. Section 3 covered contracts do not include contracts awarded under HUD's procurement program, which are governed by the Federal Acquisition Regulation (FAR). Section 3 covered contracts also do not include contracts for the purchase of supplies and materials only. However,

whenever a contract for materials includes the installation of the materials, the contract constitutes a Section 3 covered contract

Section 3 Covered Project: The construction, reconstruction, conversion or rehabilitation of housing (including reduction and abatement of lead-based paint hazards), other public construction which includes buildings or improvements (regardless of ownership) assisted with housing or community development assistance.

Small, Minority, and Disadvantaged Business Enterprise (SMDBE): A business enterprise that is 51% or more owned, controlled, and actively operated by one or more persons who experience some form of social or economic disadvantage. For the purposes of SMDBE identification, the factors for proving social or economic disadvantage include at least one objective distinguishing factor such as race, ethnic origin, gender or gender identification, physical handicap, service in the military, long-term residence in an environment isolated from the mainstream of society, or other similar causes not common to individuals who are not socially disadvantaged.

Subcontractor: Any entity (other than a person who is an employee of the contractor) which has a contract with a contractor to undertake a portion of the contractor's obligation for the performance of work generated by the expenditure of Section 3 covered assistance, or arising in connection with a Section 3 covered project.

Targeted Section 3 Worker: For public housing assistance, a Section 3 worker who is:

- (1) A worker employed by a Section 3 Business Concern; or
- (2) A worker who currently fit, or when hired within the past five (5) years fit, at least one of the following categories:
 - (i) A resident of public housing or Section 8-assisted housing; or
 - (ii) A resident of other public housing projects or Section 8-assisted housing managed by HANO; or
 - (iii) A YouthBuild participant.

YouthBuild programs: YouthBuild programs receiving assistance under the Workforce Innovation and Opportunity Act (WIOA).

U.S.C. 1701u).

Section 3 Final Rule: Section 3 Final Rule makes changes to the Section 3 regulations, now codified in 24 CFR Part 75 and is effective on November 30, 2020, designed to focus on economic opportunity outcomes while simultaneously reducing regulatory burden. These changes improve the effectiveness of Section 3, streamline some process that have not yielded significant benefits, and encourage HUD grantees to focus on sustained employment for low-and very low income individuals.

C. HANO Section 3 & DBE/WBE Policy Statements

Section 3 Policy Statement

Section 3 of the Housing and Urban Development Act of 1968, as amended (12 U.S.C. 1701, et seq.) (the “Act”) requires the Housing Authority of New Orleans to ensure that employment and other economic and business opportunities generated by financial assistance from the Department of Housing and Urban Development (“HUD”), are directed to public housing residents and other low income persons, particularly recipients of government housing assistance, and business concerns that provide economic opportunities to low and very low income persons.

With the Housing Authority of New Orleans’ (HANO) Board Resolution Number 2021-18, HANO hereby reaffirms its commitment of ensuring that all contractors and any tier subcontractors that are awarded a contract of \$100,000 or greater by HANO for work generated through the expenditure of HUD funding shall take all necessary and reasonable steps to provide meaningful, full-time, permanent employment and training to Section 3 residents. It is further reaffirmed that all vendor/contractors and any tier subcontractors that are awarded a contract for work generated through the expenditure of HUD funding shall take all necessary and reasonable steps to provide contracting opportunities to Section 3 business concerns.

To comply with the Act and Board Resolution Number 2021-18, the requirements of this policy is to obtain a reasonable level of success in the recruitment, employment, and utilization of HANO residents and other eligible persons and/or businesses by contractors working on contracts partially or wholly funded with HUD monies. HANO shall examine and consider a contractor’s potential for success in providing employment and business opportunities to those covered under Section 3 prior to acting on any proposed contract award.

In response to any Request for Proposals (RFP), Request for Qualifications (RFQ) or Invitation for Bids (IFB), HANO will require submission of the Section 3 Opportunities Plan, roster of Core Employees, and certification that the respondent will comply with the requirements of Section 3 and this policy.

HANO, in accordance with applicable laws and regulations including those published at 24 CFR Part 75 and effective on November 30, 2020, has established employment and training requirements that contractors and subcontractors are expected to meet in order to comply with Section 3 requirements.

HANO’s Section 3 requirement is that Section 3 Workers must perform 20% of all labor hours on a covered contract, and that Targeted Section 3 Workers must perform 5% of all labor hours on a covered contract.

It is the contractor’s responsibility to implement progressive efforts to attain Section 3 compliance. Failure to attain Section 3 compliance in accordance with their contract will subject contractors to penalties including, but not limited to, the withholding of payments.

Small, Minority, and Disadvantaged Business Policy Statement Consistent with Presidential Executive Orders 11625, 12138, and 12432, and as promulgated in 2 CFR Part 200 and in the Housing Authority of New Orleans’ (HANO) Board Resolution Number 2021-18, HANO hereby

modifies the numerical requirements relative to contracting with Small, Minority, and Disadvantaged Business Enterprises (SMBDE). HANO also reaffirms its commitment of ensuring that all contractors and any tier subcontractors that are awarded a contract for work generated through the expenditure of HUD funding shall take all necessary and reasonable steps to provide SMDBEs with the maximum opportunity to participate in the performance of contracts awarded by HANO.

HANO's SMDBE requirement is 30% of the value of the contract will be awarded to qualified SMDBEs. Small, Minority and Disadvantaged Business Enterprise requirements will be 25% of the value of the contract and Women Owned Business Enterprise requirements will be 5% of the value of the contract.

To comply with this requirement and Board Resolution Number 2021-18, the requirements of this policy is to obtain a reasonable level of success in the utilization of eligible businesses by contractors working on contracts partially or wholly funded with HUD monies. HANO shall examine and consider a contractor's potential for success in meeting these requirements prior to acting on any proposed contract award.

In response to any Request for Proposals (RFP), Request for Qualifications (RFQ) or Invitation for Bids (IFB), HANO will require submission of evidence and certification that the bidder will comply with the requirements of this policy.

D. Section 3 New Hire & Contracting Requirements

Section 3 Numerical Requirements and Order of Preference:

In accordance with Section 3, HANO requires that all contractors and any tier subcontractors shall provide training and employment opportunities to Section 3 residents to meet or exceed a numerical requirement of 25% of hours worked requirement. Which is 5% of hours worked for Targeted Section 3 Workers and 20% for Section 3 Workers. The priority list is:

- Priority 1: A resident of HANO housing site where the work is being done
- Priority 2: A resident of any HANO housing site
- Priority 3: A participant in HUD Youthbuild program in Orleans Parish
- Priority 4: A Section 8 assisted resident of Orleans Parish
- Priority 5: 5% Labor Hours Benchmark included within the 25% requirement

Contracting Requirements

In accordance with Section 3, HANO requires that all contractors and any tier subcontractors shall direct 10% of the contract value to Section 3 business concerns for construction contracts in the following order of priority:

- Priority 1: Business concerns that are 51% or more owned by residents of the HANO housing development or developments for which the Section 3 covered assistance is expended, or whose full-time, permanent workforce includes 30% of these persons as employees; or
- Priority 2: Business concerns that are 51% or more owned by residents of other HANO housing developments that is expending the Section 3 covered assistance, or

whose full-time, permanent workforce includes 30% of these persons as employees; or

Priority 3: HUD Youthbuild programs in Orleans Parish; or

Priority 4: Business concerns that are 51% or more owned by low or very-low income Section 3 residents, or whose permanent, full-time workforce includes no less than 30% Section 3 residents, or that subcontract in excess of 25% of the total amount of subcontracts to business concerns identified in paragraphs (1) and (2) of this section.

Section 3 businesses seeking a contract or subcontract shall be responsible for submitting evidence, if requested, to demonstrate to the satisfaction of the contracting party that the business concern is responsible and has the ability to perform successfully under the terms and conditions of the proposed contract.

Contractors must incorporate and enforce the provisions of the Section 3 policy and numerical requirements in any and all tier subcontracts. Requirements relative to employment and contracting with Section 3 residents and business concerns shall not apply to contracts less than \$100,000 and shall not apply to contracts for the purchase of supplies and materials unless the contract for materials includes installation.

In some instances, the requirements relative to contracting with Section 3 business concerns and DBEs/WBEs may overlap; however, **participation can only count toward one requirement**. For example, if a subcontract is let to a Section 3 business concern that also qualifies as a DBE, then the contractor may count the subcontract either towards its Section 3 contracting requirements or towards its DBE contracting requirements; the contractor shall not be allowed to count the participation towards both requirements.

E. DBE/WBE Contract Requirements

Numerical Requirements

HANO requires that all contractors and any tier subcontractors shall direct their subcontracting opportunities to DBEs/WBEs as follows:

- Disadvantaged Business Enterprises - 20% of the total value of contract
- Woman Business Enterprises - 5% of the total value of contract

DBE and WBE businesses seeking a contract or subcontract shall be responsible for submitting evidence, if requested, to demonstrate to the satisfaction of the contracting party that the business concern is responsible and has the ability to perform successfully under the terms and conditions of the proposed contract.

Contractors must incorporate and enforce the provisions of this policy and numerical requirements in any and all tier subcontracts. HANO must receive a copy of all tier subcontracts.

In some instances, the requirements relative to contracting with Section 3 business concerns and DBEs/WBEs may overlap; however, an individual company's participation can only count toward one requirement on a contract. For example, if a subcontract is let to a WBE concern that also qualifies as a DBE, then the contractor may count the subcontract either towards its WBE contracting requirements or towards its DBE contracting requirements; the contractor shall not be allowed to count the participation towards both requirements.

Requirements relative to contracting with DBEs/WBEs shall not apply to contracts less than \$100,000 and shall not apply to contracts where the contractor is not subcontracting for any work, materials, supplies, services, etc, or when the sole source or specified items are not available from DBEs/WBEs.

100% of the participation of DBE/WBE suppliers shall count towards the requirements as long as the supplier maintains an inventory and/or significantly alters the product for distribution. In cases where the DBE/WBE supplier does not maintain an inventory and/or does not significantly alter products for distribution, only 25% of the DBE/WBE supplier's participation shall count toward the requirements.

Part II- Procurement & Contractor Requirements and Procedures

A. Section 3 Contracting Requirements & Procedures

The procedures outlined herein shall apply to all contractors seeking contracting opportunities with the Housing Authority of New Orleans.

As part of the response to an IFB, RFP, RFQ, or other solicitation, respondents (prime) are required to submit a Section 3 Employment and Training Action Plan (SETAP) to identify overall projected employment by type and phase, Section 3 hiring, training and contracting requirements, objectives, and actions that will be implemented to ensure compliance with the requirements of Section 3. (See Section III for Section 3 Employment & Training Action Plan format).

The **HANO Section 3 Coordinator** will be responsible for coordinating with the Department of Procurement and Contracts to review the Section 3 Employment and Training Action Plan prior to the award of the contract. Upon selection, HANO will work with the selected firm to finalize the Section 3 Plan, including identification of HANO assistance to be provided (if any), timelines for action, and review of reporting and compliance requirements. The Section 3 Employment and Training plan is separate and apart from the Disadvantaged/Women Business Enterprise Plan and must be completed in addition to the DBE/WBE Plan.

I. Prior to Bid/Pre Certification Process: HANO Resident-Owned Businesses can Visit www.hano.org, to complete and submit a Section 3 Business Concerns Application.

II. Bid/Proposal Phase: Contractors submitting bids and/or proposals to HANO shall be required to complete and submit the following forms (Appendix):

- Section 3 Employment Action Plan
- Section 3 Training Action Plan
- Section 3 Contracting Action Plan
- Section 3 Employment and Training Schedule
- List of Core Employees (including date of hire for each core employee and address)
- Contracting Schedule
- Letter of Intent
- Statement of Understanding

III. Pre-Award Phase: Subsequent to the submission of bids/proposals, but prior to contract award, contractors may be requested to provide additional information regarding the submissions required in the Bid/Proposal Phase. Such requests may be made in instances where the contractor does not show sufficient detail in their required Action Plans, where the contractor's required Schedules do not reflect achievement of the minimum stated requirements, where the contractor has not identified the name of the Section 3 subcontractor(s) in the required Schedules and does not have signed Letters of Intent, or where it is deemed necessary by HANO's Section 3 Coordinator.

IV. Contract Performance Phase:

Section 3 Contract Performance Monitoring

HANO shall monitor and evaluate the contractor's Section 3 compliance towards achieving the numerical requirements relative to Section 3 employment, training, and contracting throughout the contract period. The contractor shall be responsible for providing the following reports to HANO, which shall be submitted no later than 5:00 p.m., on the fifth business day of each month throughout the contract period (Appendix):

- Core Employee List Subcontractors / New Contracts
- Section 3 Employment and Training Compliance Reports
- Section 3 Labor/Manhour Report
- Contracting Compliance Report
- Section 3 Individual Income Verification Form
- Employer Paid Training Report

Upon HANO's request, the contractor and all tier level sub-contractors are required to provide supporting documentation and proof of previous employment of any and all core employees prior to working on a HANO project.

The contractor shall also ensure that for each Section 3 resident hired, a Section 3 Individual Income Verification Form is completed. The Section 3 Individual Income Verification Form shall be completed by the resident, and submitted to the contractor. This documentation should be included with the monthly reports submitted to HANO.

The contractor shall be responsible for monitoring the compliance of any tier subcontractors. In doing so, the contractor shall require monthly reports, in the formats provided, from its lower tier subcontractors.

Determination of Compliance

Contractors and their subcontractors are required to demonstrate compliance with the Section 3 employment and contracting requirements by meeting the numerical requirements set forth above. Contractors who do not meet the contracting numerical requirements must thoroughly document its inability to comply. In addition, HANO requires contractors that fail to meet the contracting requirements set forth in this policy use the alternative measures listed on page 15 to comply. Contractor's efforts shall be directed towards identifying methods to achieve success under this program through the following requirements:

Hiring:

- Target recruitment of Section 3 residents for training and employment by taking steps such as:
 - Prominently place a notice of commitments under Section 3 at the project site or other places where applications for training and employment are taken, advertise in the local media;

- Contact HANO, HANO resident councils, HANO resident management corporations, and HANO residents;
 - Consider contracting with HANO Resident Councils and/or Resident Management Corporations;
 - Contact HANO for a list of agencies which may be able to provide assistance regarding opportunities for training which can be utilized on this contract;
 - Contact local job training centers, employment service agencies, and community organizations;
 - Develop on-the-job training opportunities or participate in job training programs;
 - Develop or participate in certified Pre-Apprenticeship/Apprenticeship Trainings Programs for construction trades on Construction Contracts and Paid Internship/Summer Employment Opportunities for Non-Construction Contracts.
- Keep a list of Section 3 area residents who apply on their own or by referral for available positions.
 - Send to labor organizations or representatives of workers with whom the recipient, contractor, or subcontractor has a collective bargaining agreement or other understanding, a notice about contractual commitments under Section 3.
 - Select Section 3 area residents, particularly HANO residents, for training and employment positions.
 - Provide ongoing monitoring of the program by the contractor and its subcontractors to ensure compliance and to identify problems or difficulties in meeting the requirements, and implement strategies to overcome the problems. Where problems or difficulties in meeting the requirements are encountered, take aggressive efforts to rectify the matter. Such action shall include, but not be limited to, convening a meeting with HANO to advise it of the problems and proposed solutions. HANO will offer its assistance whenever possible.

Where feasible, adjust the initial Section 3 and DBE/WBE Action Plan to increase the use of Section 3 residents in categories where the Plan has been successful to compensate for those categories of lower success.

B. DBE/WBE Certification

Businesses wishing to participate in HANO contracts as DBEs/WBEs must be certified by HANO's Section 3/DBE/WBE Coordinator, in the Development and Modernization Department. Businesses claiming DBE/WBE status must be certified in order to have their participation counted toward the contracting requirements stated herein. Interested businesses must initiate the certification process by submitting an application for certification to the Housing Authority. Applications for certification may be obtained by visiting HANO's website at www.hano.org.

Contracting Procedures:

The procedures outlined herein shall apply to all contractors seeking contracting opportunities with the Housing Authority of New Orleans.

I. Prior to Bid/Pre Certification Process: If qualified, contractors can visit www.hano.org, to complete and submit a Disadvantaged Business Enterprise Program Certification Application.

II. Bid/Proposal Phase: Contractors submitting bids and/or proposals to HANO shall be required to complete and submit the following forms (Appendix):

- A. DBE/WBE Contracting Action Plan
- B. Contracting Schedule
- C. Letter of Intent
- D. Statement of Understanding

III. Pre-Award Phase: Subsequent to the submission of bids/proposals, but prior to contract award, contractors may be requested to provide additional information regarding the submissions required in the Bid/Proposal Phase. Such requests may be made in instances where the contractor does not show sufficient detail in their required Action Plans, where the contractor's required Schedules do not reflect achievement of the minimum stated requirements, where the contractor has not identified the name of the DBE/WBE subcontractor(s) in the required Schedules and does not have signed Letters of Intent, or where it is deemed necessary by HANO's Compliance Officer.

IV. Contract Performance Phase: HANO shall monitor and evaluate the contractor's compliance towards achieving the numerical requirements relative to DBE/WBE contracting throughout the contract period. The contractor shall be responsible for providing the following reports to HANO, which shall be submitted no later than 5:00 p.m., on the fifth business day of each month throughout the contract period:

- Contracting Compliance Report

The contractor shall be responsible for monitoring the compliance of any tier subcontractors. In doing so, the contractor shall require monthly reports, in the formats provided, from its lower tier subcontractors.

Contracting:

- Target recruitment of DBEs/WBEs by taking such steps as:
 - Contact DBEs/WBEs in the HANO's directory;
 - Prominently place a notice of commitment relative to DBE/WBE contracting at the project site and other appropriate places;
 - Contact HANO for a list of certified firms;
 - Contact other organizations which might be helpful in identifying DBEs/WBEs and advertise in local media.

- Make every effort to use DBEs/WBEs included in HANO’s directory of certified firms. Such efforts may include, but are not limited to:
 - Dividing total work into smaller sub-tasks (i.e. by floor);
 - Using multiple firms for the same type of work (i.e. two drywall subcontractors or several plumbing suppliers);
 - Exercise flexibility in utilizing DBEs/WBEs in other or additional areas than initially proposed if necessary to meet the program objectives.

- Provide ongoing monitoring of the program by the contractor and its subcontractors to ensure compliance and to identify problems or difficulties in meeting the requirements, and implement strategies to overcome the problems. Where problems or difficulties in meeting the requirements are encountered, take aggressive efforts to rectify the matter. Such action shall include, but not be limited to convening a meeting with HANO to advise it of the problems and proposed solutions. HANO will offer its assistance whenever possible.

- Where feasible, adjust the initial DBE/WBE Contracting Action Plan to increase the use of Section 3 business concerns in categories where the Plan has been successful, to compensate for those categories of lower success.

C. Reporting Open Positions

All HANO contractors and subcontractors are required to report all job openings in connection with a contract resulting from any solicitation on HANO’s social media sites, by sending the job flyer to the Section 3 Coordinator, HANO’s website and to the onsite/project Section 3 Coordinator as soon as the job becomes available. This will aid in fulfilling the dual requirements of the shared job database by connecting low-income residents in need of employment with contractors seeking to hire Section 3 employees. Noncompliance with HANO’s requirement may result in sanctions, termination of the contract for default, and debarment or suspension from future HANO contracts.

* For Construction Projects – All new hires must go through the on-site hiring process with the Section 3 Coordinator

Part III- Compliance Requirements

Compliance Requirements for Section 3/DBE/WBE Contracting

If a contractor or subcontractor cannot meet the Section 3, DBE, WBE contracting requirements it must thoroughly document its inability to comply. In addition, HANO requires contractors that fail to meet the contracting requirements set forth in this policy use the following alternative measures to comply:

- Contractors must contribute to HANO's Section 3 Employment, Training and Contracting Fund (ETCF), which provides training and other economic opportunities for HANO residents:
 - **Trade, Construction and Rehab Contractors must contribute 2% of the total contract amount.**

HANO will primarily use the Section 3 Employment, Training and Contracting Fund to pay for resident self-sufficiency programming through HANO's partnerships with Local Colleges, State Approved Trade Programs, paid Work Experience/Internship Programs, Youth Summer Employment Programs and various other employment and training programs for residents. The site in which the construction or project is occurring will receive a portion of funds generated from that respective site for programs and equipment related to resident training.

Compliance Requirement for Project Labor Agreements or Community Workforce Agreements

HANO shall require that a Project Labor Agreement or Community Workforce Agreement be entered into between the trade unions and the developer, contractor, and subcontractors for all projects whose collective value under HANO contracts is \$25 million or more. The Project Labor Agreement or Community Workforce Agreement shall comply with all requirements of the HANO Section 3 and DBE/WBE Employment, Training, and Contracting Policy dated July 27, 2021. The unions, developers, contractors, and subcontractors shall consult with HANO, resident leaders, and community stakeholders on the terms of the agreement prior to its execution.

Part IV – Training Requirements

Training Requirements for Construction Contracts

- HANO requires all construction contracts that are greater than (\$100,000.00) one hundred thousand dollars in total construction cost and is anticipated to exceed 6 months of construction; to include a detailed and well defined plan on how they will provide a certified pre-apprenticeship or apprenticeship training programs to at least (1) one Section 3 Resident in its priority order. (1) One additional Section 3 Resident in its priority order will be provided training for every additional (\$500,000) five hundred thousand to (\$1,000,000.00) one million dollars of the total contract value. The training plan and trainings must be aligned with the scope of work in the contract and approved by HANO. A training program participant can only count for (1) one training slot per total contract amount. Those who do not offer a certified pre-apprenticeship or apprenticeship training program will contribute into the HANO Section 3 Training Fund as prescribed in the chart listed below.

Training Requirements for Non-Construction Contracts

- HANO requires that all non-Construction contracts that meet or exceed (\$100,00.00) one hundred thousand dollars in total contract value include a detailed and well defined plan to provide paid internship or summer employment opportunities to Section 3 Residents in its priority order. An internship/summer employment program participant can only count for (1) one internship/summer employment slot per total contract amount. Those who do not offer a HANO approved paid internship or summer employment opportunity will contribute into the HANO Section 3 Training Fund as prescribed in the chart listed below.

* A Portion of All Funds Generated at A HANO Housing Site Will Remain At That Site for Resident Training Programs and Equipment

Total Contract Amount	Number of Section 3 Training / Internship Slots	Contribution to HANO Training Fund if Training or Internship Slots Are not Available
At least \$100,000, but less than \$500,000	1	6% of the Total Contract Value up to \$25,000
At least \$500,000, but less than \$1,000,000	2	5% of the Total Contract Value up to \$40,000
At least \$1,000,000, but less than \$2,000,000	3	4% of the Total Contract Value up to \$60,000
At least \$2,000,000, but less than \$4,000,000	4	3% of the Total Contract Value up to \$80,000
At least \$4,000,000, but less than \$7,000,000	10	2% of the Total Contract Value up to \$105,000
\$7,000,000 or more	1 additional training slot for every additional \$500,000.00	1.5% of that Total Contract Value, with no dollar limit

Part V – Contracting and Compliance Forms



Housing Authority of New Orleans (HANO)
Section-3 Targeted Worker Individual Income Verification Form

The following information will be used to verify your individual eligibility under the Section 3 Final Rule regulations as set forth in 24 CFR Part 75.

A Section 3 resident seeking the preference in training and employment provided by this part shall certify or submit evidence to HANO and/or recipient contractor/subcontractor, if requested, that the person is a Section 3 resident.

I, _____, residing at _____
(print name) (address)

_____ have a family size of _____ and my total
(city, state, zip code)

annual income for the prior calendar year (20__) was \$_____ as is evidenced by the attached documentation.

Proof of income and residency is a requirement for an individual to become Section-3 certified.

For proof of residency I have provided at least one of the following:

- Copy of lease
2-months of Utility Bills
Notarized statement from an individual with at least one of the above documents in their name attesting that the person seeking Sec-3 Certification is living at their residence
One of the acceptable proofs of income listed below that clearly indicates the applicant is a Orleans Parish resident
Valid State ID

For proof of income I have provided at least one of the following:

- Copy of receipt of public assistance
Copy of Evidence of participation in a public assistance program
Proof of income (Check stub, W-2, Tax forms, 1099, employer letter on letterhead, etc.)
Proof of Unemployed Status

I have voluntarily provided the above information in conjunction with employment on a HUD related project. I attest to the truthfulness of my statements fully understanding that this information is subject to verification by the appropriate federal agencies.

Signature _____ Date _____

Contact Phone: _____

Title 18, Section 1001 of the U.S. Code states that a person is guilty of a felony for knowingly and willingly making false or fraudulent statements to any department of the United States Government.
Willful falsification of any of the above statements may subject the contractor or subcontractor to civil or criminal prosecution. See Section 1001 of Title 18 and Section 231 of Title 31 of the U.S. Code.



Housing Authority of New Orleans (HANO) SECTION 3 REQUIREMENTS

Consistent with the requirements of Section 3 of the Housing and Urban Development Act of 1968, as amended (12 U.S.C. 1701u) and with the Housing Authority of New Orleans' (HANO) Board Resolution Number 93-05, HANO hereby reaffirms its commitment of ensuring that all contractors and any tier subcontractors that are awarded a contract in excess of \$100,000.00 by HANO for work generated through the expenditure of HUD funding shall take all necessary and reasonable steps to provide meaningful, full-time, permanent employment and training to Section 3 residents. It is further reaffirmed that all contractors and any tier subcontractors that are awarded a contract in excess of \$100,000.00 by HANO for work generated through the expenditure of HUD funding shall take all necessary and reasonable steps to provide business opportunities to Section 3 business concerns.

Definitions:

Low-Income Person:

An individual whose income does not exceed 80% of the median income for the area, as determined by the Secretary of the U.S. Housing and Urban Development.

Hours Worked Requirement:

- 1) 25% Section 3 Worker. Is a worker whose individual income is below the low-income limit of 80% AMI, or employed by a low income business concern or a worker who currently fits or when hired fit at least one of the Section 3 Worker and/or Resident categories.
- 2) 5% Targeted Section 3 Worker. Is a worker employed by a Section 3 business concern or a worker who currently fits or when hired fit at least one of the Section 3 Worker and/or Resident categories, as documented within the past 5 years

Section 3 Worker and/or Resident:

- 3) A resident of HANO housing site where the work is being done; or
- 4) A resident of any HANO housing site; or
- 5) A participant in HUD Youthbuild program in Orleans Parish; or
- 6) An income-eligible resident of public housing or Section 8 assisted housing managed by HANO and providing assistance to resident of Orleans Parish; or
- 7) 5% Labor Hours Benchmark included within the 25% requirement.

Statement of Numerical Goals and Order of Preference:

In accordance with Section 3, HANO requires that all contractors and any tier subcontractors shall, to the greatest extent feasible, provide training and employment opportunities to Section 3 residents to meet or exceed a numerical goal of 25% of all Section 3 Workers and 5% of Targeted Section 3 Workers for Hours Worked Requirement new hires in the following order of priority:

- | | |
|-------------|--|
| Priority 1: | A resident of HANO housing site where the work is being done |
| Priority 2: | A resident of any HANO housing site |
| Priority 3: | A participant in HUD Youthbuild program in Orleans Parish |
| Priority 4: | A Section 8 assisted resident of Orleans Parish |
| Priority 5: | 5% Labor Hours Benchmark included within the 25% requirement |



ORLEANS PARISH, LOUISIANA

SECTION 3 ANNUAL INDIVIDUAL INCOME LIMITS 2021

Limits DO NOT apply to residents of HANO development sites

Orleans Parish Median Income: \$70, 100

FY 2021 Income Limit Category	1	2	3	4	5	6	7	8
	Person	Person	Person	Person	Person	Person	Person	Person
<u>Low (80%) Income Limits</u>	\$39,300	\$44,900	\$50,500	\$56,100	\$60,600	\$65,100	\$69,600	\$74,100

Definition of Section 3 Resident:

- 1) A resident of HANO housing site where the work is being done; or
- 2) A resident of any HANO housing site; or
- 3) A participant in HUD Youthbuild program in Orleans Parish; or
- 4) An income-eligible resident of public housing or Section 8 assisted housing managed by HANO and providing assistance to low or very low-income resident of Orleans Parish; or.
- 5) 5% Labor Hours Benchmark included within the 25% requirement.

*Source – HUD FY 2020 Income Limits Documentations System, [FY 2021 Income Limits Documentation System -- Summary for Orleans Parish, Louisiana \(huduser.gov\)](https://www.huduser.gov/portal/section8/summary/orleans-parish-louisiana)



HOUSING AUTHORITY OF NEW ORLEANS

SECTION 3 EMPLOYMENT ACTION PLAN

(Note: FINAL PLAN WILL BE INCORPORATED INTO CONTRACT, IF AWARDED.)

Provide a written Plan describing the process and steps that will be taken to ensure that the requirements relative to the hiring of Section 3 residents will be met. Include in the description what specific actions will be taken to ensure that subcontractors comply with the requirements. The description must outline specific steps to be taken and detail the program or strategy to be employed to achieve the requirements. For construction and related contracts where the General Contractor is unknown at the bid/proposal stage, Respondent must outline a process for meeting the stated requirements and commit to providing a detailed job projection within 30 days of contract execution. Complete attached Employment and Training Schedule outlining job projections by category and anticipated timeline.

NOTE: This plan shall incorporate actions to be taken by the bidder's/offeror's proposed subcontractors/suppliers.

Name: _____ Title: _____ Date: _____



HOUSING AUTHORITY OF NEW ORLEANS

CONTRACTING ACTION PLAN FOR SECTION 3/DBE/WBE

(FINAL PLAN WILL BE INCORPORATED INTO CONTRACT, IF AWARDED.)

Provide a written Plan describing the process and steps that will be taken to ensure that the requirements relative to contracting with Section 3 businesses, Minority and Women Business Enterprises will be met. Include in the description what specific actions will be taken to ensure that subcontractors comply with the requirements. The description must outline specific steps to be taken and detail the program or strategy to be employed to achieve the requirements. Provide an outline of the specific contracts that will be awarded to Section 3/DBE/WBE businesses, if known. Use additional sheets of paper, if necessary.

NOTE: This plan shall incorporate actions to be taken by the bidder's/offeror's proposed subcontractors/suppliers.

Name: _____ Title: _____ Date: _____



HOUSING AUTHORITY OF NEW ORLEANS

LIST OF CORE EMPLOYEES

CONTRACT EXECUTION DATE: _____

List all regular, permanent employees who are currently performing work, or who normally perform work for your company when work is available. Duplicate form if additional space is needed.

EMPLOYEE NAME/ADDRESS	DATE OF HIRE	JOB CLASSIFICATION
Example: John Doe 1515 Mockingbird Lane City, State	10/10/00	Plumber

Core Employee: Contractor's regular, permanent employee who normally performs work for the contractor when work is available.

Name: _____ Title: _____ Date: _____



**HOUSING AUTHORITY OF NEW ORLEANS
CONTRACTING SCHEDULE**

Contracting Schedules that do not reflect a level of participation that meets or exceeds the stated requirements may cause the bid to be deemed non-responsive. Section 3, DBE, and WBE firms not certified by HANO shall not be included on this schedule and shall not be counted towards the participation requirements. Duplicate form if additional space is needed.

ITEM #	DESCRIPTION OF WORK TO BE PERFORMED	NAME AND ADDRESS OF COMPANY TO BE USED TO PERFORM THE WORK	TYPE OF WORK TO BE PERFORMED			TOTAL ESTIMATED AMOUNT OF WORK TO BE PERFORMED		
			LABOR	MATERIALS	BOTH	SECTION 3	DBE	WBE
EXAMPLE	PAINTING	John Doe Resident Owned Painter, Inc. New Orleans, LA			X	\$50,000		
1.								
2.								
3.								
4.								
5.								
6.								
7.								

Summary:

- 1) Total Amount to be Awarded to Section 3 Business Concern: \$ _____ Percentage of Total Contract Amount _____%
- 2) Total Amount to be Awarded to DBE: \$ _____ Percentage of Total Contract Amount _____%
- 2) Total Amount to be Awarded to WBE: \$ _____ Percentage of Total Contract Amount _____%

Name: _____ Title: _____ Date: _____



**HOUSING AUTHORITY OF NEW ORLEANS SECTION 3
EMPLOYMENT AND TRAINING SCHEDULE**

IFB NO. _____

Employment and Training Schedules that do not reflect a level of participation that meets or exceeds the stated requirements may cause the bid to be deemed non-responsive. Duplicate form if additional space is needed. The Section 3 requirements set forth in this policy are

Job Category	Total Estimated Positions Needed for Contract	Total Estimated Number of Workforce Labor/Man hours Needed for Contract	Total Number of Positions Currently Occupied by Core Employees	Total Estimated Number of Workforce Labor/Manhours to be Performed by Current Core Employees	Total Estimated Number of Workforce Labor/Manhours to be Performed by Section 3 Residents	Training Plan			
						List Types of Pre-Apprenticeship and Apprenticeship Trainings That Will Be Provided to Section 3 Employees/HANO Residents	Number of "On The Job Training" Positions Available to Section 3 Residents	List The Name Of The Training Program Provider	What Type of Certification Will Be Provided At The Completion of Training
Ex. Clerical	2	80 hours	1	50 hours	30 hours		1		

Name: _____ Title: _____ Date: _____



HOUSING AUTHORITY OF NEW ORLEANS

LETTER OF INTENT – Subcontractor Commitment Form

To: _____ IFB# _____
Name of Prime Contractor

The undersigned will enter into a signed agreement with the Prime Contractor listed above. Copies of agreements including, but not limited to joint ventures, subcontracts, supplier agreements or purchase orders referencing the IFB, RFP, RFQ, or Purchase Order Number shall be forwarded to HANO at:

Housing Authority of New Orleans
4100 Touro Street
New Orleans, Louisiana 70122
Attn: Section 3/DBE/WBE Coordinator

Name of Subcontractor _____

Description of Work to Be Performed by Subcontractor _____

Contract Value (inclusive of change orders) \$ _____

Term of Contract (include start and end dates) _____

Subcontractor Status (Section 3, DBE, WBE) _____

By: _____
Prime Contract Signature

Printed or Typed Name

Title: _____

Date: _____

If a corporate seal is not affixed, this document must be notarized. Provide Letter of Intent on Company Letterhead.

Subscribed and sworn to _____ (Notary Public)
before me this _____ day of _____, 20____ (Seal)

My Commission expires: _____

Date Executed: _____



HOUSING AUTHORITY OF NEW ORLEANS

STATEMENT OF UNDERSTANDING

IFB NO. _____

Under penalties of perjury, as prescribed in 18 U.S.C. 1001, the undersigned certifies that it:

- o Has prepared and submitted its bid/proposal to HANO with a full understanding of HANO's requirements with respect to employment, training, and contracting with Section 3 residents, Section 3 business concerns, Disadvantaged Business Enterprises (DBEs), and Women Business Enterprises (WBEs); and
- o Agrees to act in good faith to ensure that the specified requirements relative to employment, training, and contracting are met; and
- o The representations contained in the Section 3 Employment and Training Action Plan submitted with the bid/proposal are true and correct as of this date; and
- o Proposes to use the services of the Section 3 business concerns, DBEs, and WBEs listed in the Contracting Action Plan; and
- o Will not alter the level of employment, training, and contracting with Section 3 residents, Section 3 business concerns, DBEs, and WBEs identified in the Section 3 Employment and Training Schedule and in the Contracting Schedule without prior written notice to HANO; and
- o Agrees to provide regular compliance reports to HANO, at the intervals specified by HANO and in the format specified by HANO; and
- o Will monitor, ensure, and report subcontractor compliance with respect to HANO's employment and contracting requirements;
- o Will provide HANO with documentation in the format and timeframe requested by HANO, such as subcontractor certifications, employee income verifications, etc. to confirm eligibility of those employees, trainees, subcontractors claiming Section 3, DBE, and/or WBE status.

Bidder's/Offeror's Name

By: _____
Signature

Printed or Typed Name

Title: _____

Date: _____

If a corporate seal is not affixed, this document must be notarized.

Subscribed and sworn to _____ (Notary Public)
before me this _____ day of _____, 20____ (Seal)

My Commission expires: _____

Date Executed: _____

Monthly Reporting Forms for HANO's Employment, Training, and Contracting Policy

Instructions: Complete the attached forms and return them to HANO by close of business on the 1st business day of each month. All contractors and subcontractors with contracts valued at \$100,000.00 (One-hundred Thousand dollars) or more are subject to the requirements of HANO's Employment, Training, and Contracting policy, and must complete and return these forms to remain in compliance with their contract provisions. Each form captures a different vital piece of information to measure the contractor's progress towards attaining their ETC goals, and must be completed to the satisfaction of the Compliance Specialist before being accepted.

Form A (Section 3 Hires and Trainees): This report must include all new hires and trainees on boarded during the reporting period. Failure to include all new hires will result in the report being rejected by the Compliance Officer. This report must also include each Section 3 individual hired in the reporting period and list them by preference category:

- Priority 1: A low or very low-income resident of HANO housing site where the work is being done
- Priority 2: A low or very low-income resident of any HANO housing developments
- Priority 3: A participant in HUD Youthbuild program in Orleans Parish
- Priority 4: HANO Housing Choice Voucher Participant
- Priority 5: a) A Very low-income resident of Orleans Parish
b) A Low-income resident of Orleans Parish

Form B (Labor Utilization and Man-hours): List all Employees including Section 3 residents who have performed work in connection with this project to date. For each Section 3 employee, please attach a Section 3 Resident Certification form and Section 3 Income Verification Worksheet with supporting documentation. Section 3 employees without this information will NOT be counted towards your Section 3 requirements.

Form C (Employer Paid Training): Report all training paid for by the employer in the reporting period. This should include the attendee's name, training description, total cost, and all other relevant information.

Form D (Contracting Compliance): List ALL Section 3/DBE/WBE Contractors/Subcontractors and Suppliers utilized on this contract to date. Copies of all contracts/supplier agreements executed during this reporting period must be submitted with this report.

Additional Space: In the event that you should require additional space, please duplicate the appropriate form and indicate the total number of copies (Page x of x) on the form(s).

Contact Information: Please provide a point of contact for your company/organization in the event there should be questions or corrections required to your reporting:

Project Name:	<input type="text"/>	Project Number:	<input type="text"/>	Reporting Period:	<input type="text"/>
Name:	<input type="text"/>	Title:	<input type="text"/>	Company:	<input type="text"/>
Phone:	<input type="text"/>	Email:	<input type="text"/>	Signature:	<input type="text"/>

Form A: Section 3 Hires and Trainees Compliance Report

Craft/Trade	Total Number of New Hires	Tier 1 Residents Hired	Tier 2 Residents Hired	Tier 3 Residents Hired	Tier 4 Residents Hired	Tier 5 (a) Residents Hired	Tier 5 (b) Residents Hired	Total Number of Section 3 Residents Hired	Percentage of Section 3 New Hires	Total Number of Section 3 Residents in Apprenticeship Programs
<i>Laborer</i>	6	2	1	0	0	3	0	6	100%	2
Total										

Project Name: _____ Project Number: _____ Reporting Period: _____

Signature: _____ Date: _____

Form C: Employer Paid Training Report

Attendee Name	Training Name/Description	Training Provider	Training Dates	Training Hours	Total Dollar Cost of Training & Materials
John Smith	Welding Classes	Delgado	9/18-27/2019	40	\$800
Total					

Project Name: Project Number: Reporting Period:

Signature: Date:

Form B: Section 3 Labor Utilization Report

Name	Address (City, State, Zip)	Section 3 Category Preference	Craft/Trade	Number of Man-hours Worked This Period	Hire Date	Termination Date	Total Man-hours
John Smith	123 Main Street, New Orleans, LA 70117	2	Labourer	125	1/20/2018	Current	523
Total							

For the Period of this report, indicate:

Total Number of Man-hours worked by all Employees:

Total Number of Man-Hours worked by Section 3 Employees:

Percentage of Total Man-Hours worked by Section 3 Employees:

Project Name:

Project Number:

Reporting Period:

Signature:

Date:



****Attach Section 3 Resident Certification Forms for each new hire reported.**

Form D: Contracting Compliance Report

Name of Subcontractor/ Supplier	Indicate HANO Certification (DBE/WBE, SEC 3)	Scope of Work Performed/To Be Performed	Method of Procurement (Public Bid, RFP, etc.)	Total Subcontract Amount (including Change Orders)	Amount Paid this Period	Amount Paid to Date	Balance Due
<i>Jim's Plumbing</i>	<i>DBE</i>	<i>Plumbing, Pipefitting</i>	<i>Public Bid</i>	<i>\$25,000</i>	<i>\$6,000</i>	<i>\$18,000</i>	<i>\$7,000</i>
Total							

Total Amount Paid to Contractor by HANO or Prime Contractor: This Period: \$ _____ To Date: \$ _____

Total Amount Paid by Contractor to Section 3 Business Concerns: This Period: \$ _____ To Date: \$ _____

Total Amount Paid by Contractor to DBE/WBEs: This Period: \$ _____ To Date: \$ _____

Total Amount Paid by Contractor to WBEs: This Period: \$ _____ To Date: \$ _____

Project Name: _____ Project Number: _____ Reporting Period: _____

Signature: _____ Date: _____



Section 3 Employment and Training Assessment

This Assessment is designed to capture potential Section 3 Certified candidates' employment interest, work experience and training information. Information will be forwarded to employers based upon the skills required for the open positions. Applicants will be considered for positions without regard to race, color, religion, sex national origin, age or marital status.

Personal Information

Name _____ Date _____

Address _____

City _____ State _____ Zip _____

Home Telephone _____ Alt. Telephone _____

Current Age _____ Date of Birth _____

Do you reside at a HANO affordable housing site? () YES () NO

If Yes, Which Site: _____ Name of Individual _____ Are you a HANO

Housing Choice Voucher Participant () YES () NO

If Yes, Name of Individual _____

Do you reside at a federally supported housing unit? () YES () NO

Are you a HUD Youth Build Participant? () YES () NO

Education

Highest Level of Education (Grade Completed) _____

High School Diploma _____ GED _____ Some College _____

College _____ List Degree _____ Year Completed _____

Name of last School Attend _____ City _____ State _____

Last Year Attended _____

Employment

1. Have you ever worked before? Yes _____ No _____

2. Are you currently working? Yes _____ No _____ Full Time _____ Part Time _____

3. Current Job Title _____ Hourly Rate _____

4. Have you ever completed an occupational skills training? If so, what, when and where.

5. Do you have an occupational skills credential/license? If so, what and expiration date.

6. Have you ever participated or completed work readiness training? If so, when.

7. Are there any problems or issues that may prevent you from working consistently? If so, explain.

8. What type of environment would you like to work in? ___ Indoors ___ Outdoors

9. What types of machinery/office equipment do you know how to operate?

Employment History

Name of Employer Address/ City/State	Dates of Employment Start/End	Job Title	Beginning Hourly Rate Ending Hourly Rate	Reason For Leaving

Transportation

1. Do you have a valid driver's license? Yes _____ No _____ State _____

2. Do you own a car or have access to reliable transportation to get to and from work?

Yes _____ No _____ If yes, make /model/year of car.

If no vehicle or license, what is your primary means of transportation? _____

References: DO NOT INCLUDE RELATIVES.

Name _____ Address _____

City _____ State _____ Zip Code _____

Telephone _____ Position/Relationship _____

Name _____ Address _____

City _____ State _____ Zip Code _____

Telephone _____ Position/Relationship _____

Name _____ Address _____

City _____ State _____ Zip Code _____

Telephone _____ Position/Relationship _____

Signature: _____ Date: _____

Print Name: _____

SKILLS ASSESSMENT

I. Place an (X) on the area(s) in which you have skills and list the number of years of experience.

Trade	# Of Years Experience	Trade	# Of Years Experience
<i>Carpentry</i>		<i>Drywall</i>	
Form Carpentry		Painting	
Cement Forms Finisher		Drywall Hanger	
Rough Frame Carpentry		Drywall Finisher	
Finish Carpentry			
Finish Interior Carpenter		<i>Flooring</i>	
Finish Exterior		Carpet Installation	
Door Installation		Tile Setting	
Window Installation		Wood Flooring Installation	
<i>Machine Operation</i>		<i>Misc. Items</i>	
Forklift		Appliance Installation	
Boom/lift		Fencing	
Bob Cat		Landscaping	
Back Hoe		Plumbing	
Excavator		Plumbing Fixture Install	
Sweeper		Janitorial	
		HVAC	
<i>Electrical</i>		Security	
Electrical (wiring)		General Labor	
Electrical (Connection)		Other 1	
Electrical (Fixture Install)		Other 2	
		Other 3	
<i>Concrete / Masonry</i>		Other 4	
Cement			
Steel Setter			
Business	# Of Years Experience	List any Other Field	# Of Years Experience
Administrative Assistant			
Accountant			
Architect			
Engineer			
Social Service			
File Clerk			
Legal Aid Assistant			
Receptionist			
Mail Clerks			
Clerical Assistant			
Customer Service Rep			
Project Assistant			

I. Please place an (X) by the area(s) in which you are interested in training.

<input type="checkbox"/>	Carpentry	<input type="checkbox"/>	Electrical	<input type="checkbox"/>	Painting
<input type="checkbox"/>	Carpet Installation	<input type="checkbox"/>	Cement / Masonry	<input type="checkbox"/>	Fencing
<input type="checkbox"/>	Drywall	<input type="checkbox"/>	Landscaping	<input type="checkbox"/>	Plumbing
<input type="checkbox"/>	Tile Setting	<input type="checkbox"/>	Wood Flooring installation	<input type="checkbox"/>	Iron Work
<input type="checkbox"/>	Machine Operation	<input type="checkbox"/>	HVAC	<input type="checkbox"/>	Appliance Installation
<input type="checkbox"/>	Bricklaying	<input type="checkbox"/>	Janitorial	<input type="checkbox"/>	General labor
<input type="checkbox"/>	Security	<input type="checkbox"/>	Window Installation	<input type="checkbox"/>	Door Installation
<input type="checkbox"/>	Fixtures Installation	<input type="checkbox"/>	Other	<input type="checkbox"/>	

<input type="checkbox"/>	HAZMAT	<input type="checkbox"/>	LIST OTHERS	<input type="checkbox"/>	
<input type="checkbox"/>	HAZWOPER	<input type="checkbox"/>		<input type="checkbox"/>	
<input type="checkbox"/>	Truck Driving	<input type="checkbox"/>		<input type="checkbox"/>	
<input type="checkbox"/>	OSHA	<input type="checkbox"/>		<input type="checkbox"/>	
<input type="checkbox"/>	Pipe laying	<input type="checkbox"/>		<input type="checkbox"/>	
<input type="checkbox"/>	Green Construction	<input type="checkbox"/>		<input type="checkbox"/>	
<input type="checkbox"/>		<input type="checkbox"/>		<input type="checkbox"/>	
<input type="checkbox"/>		<input type="checkbox"/>		<input type="checkbox"/>	

II. Comments

Attachment Q Statement of Bidder's Qualifications



**HOUSING AUTHORITY OF NEW ORLEANS
PROCUREMENT AND CONTRACTS DEPARTMENT**

INVITATION FOR BIDS #23-912-41

STATEMENT OF BIDDER'S QUALIFICATIONS

This form must be submitted with each bid or proposal. Each business of a joint venture must submit this form. Complete all blanks by entering the requested information or "NA" if it is not applicable to your business.

BUSINESS NAME:		
AVG. ANNUAL SALES (LAST 3 YEARS):	CURRENT NET WORTH:	DATE BUSINESS STARTED:
PARENT COMPANY (IF AFFILIATE):		PREVIOUS BUSINESS NAME:

OFFICERS, OWNERS, OR PARTNERS

NAME	OFFICIAL CAPACITY

PERSONS AUTHORIZED TO SIGN OFFERS AND CONTRACTS IN COMPANY NAME

NAME	OFFICIAL CAPACITY

BANK REFERENCE

BANK NAME:	ADDRESS:
CONTACT PERSON:	TELEPHONE NO.:

STATEMENT OF BIDDER'S QUALIFICATIONS (CONT.)**QUALITY ASSURANCE**

	YES	NO
A. Has the Bidder has successfully completed three similar projects within the past five years?		
B. Over the past five years, has the Bidder completed all of their projects within the contract time frame and budget?		
C. Over the past five years, has the Bidder ever been Terminated for Default by any public entity?		
D. Over the past five years, has the Bidder ever been issued a finding of non-compliance by HANO relative to DBE, WBE and Section 3 Employment and Contracting?		
E. Over the past five years, has the Bidder ever been issued a finding of non-compliance relative to Davis Bacon Wage Requirements?		

BUSINESS REFERENCES (Provide three existing or completed work activities by your business which are similar to or support your ability to successfully complete the scope of work.) Please attach additional pages if additional space is needed.

AGENCY/COMPANY NAME:	ACTIVITY:	DOLLAR AMOUNT:
DATE COMPLETED:	CONTACT PERSON:	TELEPHONE NO.:
AGENCY/COMPANY NAME:	ACTIVITY:	DOLLAR AMOUNT:
DATE COMPLETED:	CONTACT PERSON:	TELEPHONE NO.:
AGENCY/COMPANY NAME:	ACTIVITY:	DOLLAR AMOUNT:
DATE COMPLETED:	CONTACT PERSON:	TELEPHONE NO.:

The undersigned covenants and agrees to provide the Housing Authority of New Orleans current, complete, and accurate information regarding their business' status. The undersigned further agrees to permit examination of books, records, and files by authorized representatives of the Housing Authority of New Orleans or the U.S. Department of Housing and Urban Development. Any material misrepresentation may be grounds for terminating any contract which may be awarded and for initiating action under federal or state laws concerning false statements.

SIGNATURE OF PRINCIPAL:	PRINTED NAME OF PRINCIPAL:	DATE SIGNED:
-------------------------	----------------------------	--------------

Attachment R

Corporate Resolution

(Bidder may use this form or
their own corporate resolution)



CORPORATE RESOLUTION

I, _____, the undersigned Secretary of _____ (The "Corporation") hereby certifies that: The Corporation is duly organized and existing under the laws of the State of _____ and the following is true, accurate and complete transcript of a resolution contained in the minute book of the Board of Directors of said Corporation duly held on the _____ day of _____, _____ at which meeting there was present and acting throughout a quorum authorized to transact business hereinafter described, and that the proceedings of said meeting were in accordance with the charter and by-laws of said Corporation and that said resolutions have not been amended or revoked and are in full force and effect:

Resolved, that _____ (name), _____ (title) of the Corporation, be and is hereby authorized and empowered to sign any and all documents on behalf of said Corporation, and to take such steps, and do such other acts and things, as in his or her judgment may be necessary, appropriate or desirable in connection with any proposal submitted to, or any contract entered into with the City of Austin: and,

Resolved, that any and all transactions by and of the officers or representatives of the Corporation, in its name and for its account, with the City of Austin prior to the adoption of these resolutions be, and they are hereby, ratified and approved for all purposes.

Witness my hand and seal of the Corporation this _____ day of _____, 202_.

Secretary-Treasurer

(Corporate Seal)